



SLIP-ON MOTORCYCLE MUFFLER FOR HONDA NT1100 22-23

- Represents the first step in the exhaust system tuning process
- Easy to install and offers a great balance between price and performance
- More power, more torque, less weight and the unique Akrapovic sound
- EC/ECE Type approval

DESCRIPTION

Single titanium muffler w/ carbon fiber end cap (includes carbon fiber heat shield; will fit w/ Honda side cases and center stand)



PART #

1811-4436



LV-PRO EXHAUST SYSTEM FOR HONDA CB650R 19-23

- Racing look
- Shark cut end cap

HEADER/MUFFLER/END CAP

Stainless/ carbon/ carbon



PART #

1810-2677



See chart for details

LV ONE EVO EXHAUST SYSTEM FOR YAMAHA X-MAX 125/TECH MAX 21-23

- The latest EVOLUTION of the popular LV ONE: Aggressive Sound and Style
- Clean, laser-etched Leo Vince logo in an innovative carved design (for the carbon-fiber exhaust: bright aluminum die-cut high-temp resistant Leo Vince adhesive logo)
- Asymmetric design and high-temp resistant full-carbon fiber end cap
- Impact-resistant sandblasted oval AISI 304 stainless steel sleeve – titanium look
- TIG-welded stainless steel front cup
- Adjustable full-carbon fastening strap
- Removable dB Killer, weight savings and flawless installation

HEADER/MUFFLER/END CAP

Stainless/stainless/carbon

APPROVALS

ECE type approval

PART #

1810-3123





1811-4444



1811-4445

**LV-10 SLIP-ONS
FOR BMW S 1000 XR ABS 20-23**

- Compact and lightweight design
- Made from AISI 304 stainless steel
- Sandblasted end cap
- High-heat-resistant thermal packing
- Stainless or matte black finish
- Laser-etched logo
- Fits with original panniers



See chart
for details

TAILPIPE/MUFFLER/END CAP	APPROVALS	PART #
Stainless/stainless/stainless	ECE type approval	1811-4444
Stainless/black stainless/stainless	ECE type approval	1811-4445



1811-4451



1811-4452



See chart
for details

**LV ONE EVO SLIP-ONS
FOR HONDA CB 750 HORNET 23**

- The latest EVOLUTION of the popular LV ONE: Aggressive Sound and Style
- Clean laser-etched Leo Vince logo in an innovative carved design (for the carbon-fiber exhaust: bright aluminum die-cut high-temp resistant Leo Vince adhesive logo)
- Asymmetric design and high-temp resistant full carbon-fiber end cap
- Impact-resistant sandblasted oval AISI 304 stainless steel sleeve – titanium look
- TIG-welded stainless steel front cup
- Adjustable full-carbon fastening strap
- Removable dB killer, weight savings and flawless installation
- Universal mufflers are measured by inlet diameter and housing length
- ECE approved



1811-4453

TAILPIPE/MUFFLER/END CAP	DESCRIPTION	PART #
Stainless/stainless/carbon	ECE type approval	1811-4451
Stainless/black stainless/carbon	ECE type approval	1811-4452
Stainless/carbon/carbon	ECE type approval	1811-4453

LeoVince



See chart
for details

LV ONE SLIP-ON MUFFLERS FOR DUCATI DESERT X 950 ABS 22-23 (INCLUDING 35 kW VERSION)

- Fully tested internals are coupled with a completely new outer, and with an attractive quality/price relationship
- The muffler is constructed completely of TIG-welded AISI 304 stainless steel and is oval shaped, with flat upper and lower zones
- Externally it is finished with a special sand blasting treatment, which gives it a "titanium look"; carbon-fiber muffler casing also available
- The geometrical development of the muffler is specific for each engine model, aimed to enhance the torque and maximum power
- ECE approved



1811-4440

1811-4442



TAILPIPE/MUFFLER/END CAP	APPROVALS	PART #
Stainless/stainless/carbon	ECE type approval	1811-4442
Stainless/black stainless/carbon	ECE type approval	1811-4443

¹ Does not fit with center stand.

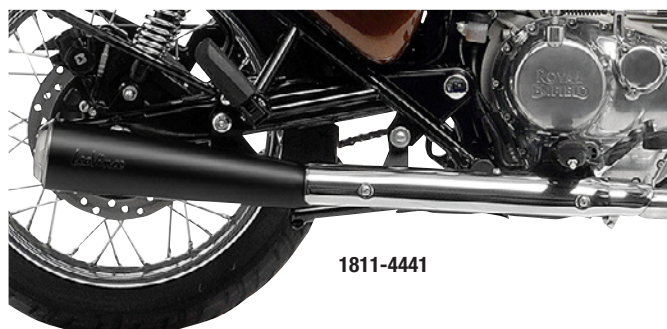

1811-4441

CLASSIC RACER SLIP-ONS

- Weight: 2.14 kg (-1.22 kg vs the OEM)
- AISI 304 stainless steel
- End cap with brushed finish
- Embossed LeoVince logo
- Classic "retro" sound
- Easy to install

FITS MODEL	TAILPIPE/MUFFLER/END CAP	APPROVALS	PART #
ROYAL ENFIELD			
Classic 350 21-23	Stainless/stainless/stainless	ECE type approval	1811-4440
	Stainless/black stainless/stainless	ECE type approval	1811-4441
Meteor 350 21-23	Stainless/stainless/stainless	ECE type approval	1811-4440
	Stainless/black stainless/stainless	ECE type approval	1811-4441



LINK PIPE KIT FOR DUCATI MULTISTRADA 950/S 21

- Includes a resonator to reduce offensive exhaust tones and a plate for the exhaust valve to eliminate CEL on the dash (where applicable)
- Made of stainless steel AISI 304, TIG-welded
- Rig-tested and manually manufactured
- Compatible w/ OEM and LeoVince exhaust, original panniers and original under cowl

NOTE: When fitting this exhaust system it is advisable to optimize the carburetion by remapping the stock ECU unit or adopting an additional ECU unit.

FITS MODEL	PART #
Link pipe kit	1812-0570



dB KILLER

- Optional noise reducer for LV-10 Ø 60
- Not suitable for LV-10 carbon fiber

DESCRIPTION	PART #
dB Killer	1860-2413



FORCE FULL EXHAUST SYSTEMS

- Top-quality full systems developed for important teams racing the world championships and tested on the most famous race tracks
- Offers both professional and amateur riders maximum performance
- Collectors are TIG welded in AISI304 stainless steel or titanium, for maximum lightness
- Shape, sharp and symmetric, allows maximization of the volume and specific diameters to grant a further power increase
- Exhausts are homologated with catalyst; unless noted

FITS MODEL	DESCRIPTION	PART #
KAWASAKI		
ZX-6 R 600 09-16,13-19/ 636 13-19/ ABS 13-23	Full system with stainless steel collector and titanium muffler	1810-3122



EVO II FULL EXHAUST SYSTEM

- Full system with titanium muffler, stainless steel collector D.52-60-52, number plate and light holder
- Collectors are TIG™-welded AISI304 stainless steel
- Muffler specifically designed for the superbike tail
- Homologated
- EC approved

FITS MODEL	PART #	FITS MODEL	PART #
DUCATI		DUCATI (CONT)	
Panigale V2 955 ABS 20-23	1810-3121	Panigale 959 ABS 16-19	1810-3121
Panigale V2 955 TB ABS (Bayliss edition) 22-23	1810-3121		

GRID-O SLIP-ON MUFFLERS

- Improved performance compared to standard exhaust
- Aggressive sound and style
- Mufflers are TIG-welded, and 3D laser-cut using state-of-the art technology
- Connects to catalyzed collector
- Homologated
- Made of titanium



FITS MODEL	PART #
TRIUMPH	
Street Triple RS/R/S 17-20	1810-3119

DAKAR SLIP-ON MUFFLERS

- The Dakar shape perfectly fits the style of this Desert Rally Icon
- Developed with the latest technologies and materials
- Available in four different materials
- Homologated
- ECE approved



DESCRIPTION	PART #	DESCRIPTION	PART #
APRILLA		YAMAHA	
Tuareg 660 22	1811-4447	XZT 690 SP 21-22	1811-4448
			1811-4449
		YAMAHA (CONT)	
		XZT 690 19-22	1811-4448
			1811-4449



1831-1052



1831-1053



1831-1051

DUAL SLIP-ON EXHAUSTS

- Built and assembled in northern Sweden
- All cans and tubes are SS304 stainless steel
- All aluminum parts are CNC-machined from 6061 billet
- Precision TIG-welded with high-quality filler rod; mandrel-bent tubing
- Great power increase
- Spark arrestor included

NOTE: All exhausts and mufflers are bolt-on and are made to fit stock vehicles; any aftermarket modifications or additions may affect exhaust fit

FITS MODEL	MUD EDITION PART #	APX PART #
CAN-AM		
Renegade 500/800/1000 (G2) 12-23	-	1831-1063
Renegade 570 16-23	-	1831-1063
Renegade 850 17-23	-	1831-1063
CF MOTO		
800/850/1000 XC 18-23	-	1831-1052

MUD EDITION EXHAUSTS

- One of the most exclusive exhausts released by RJWC
- One of the most refined top-tier exhausts for ATVs
- Incredible deep and clean sound

APX EXHAUSTS

- All aluminum modular exhaust
- CNC-machined brackets on all critical points
- CAD drawn with extruded aluminum cans
- Casted stainless intake flanges and new inner cores

FITS MODEL	MUD EDITION PART #	APX PART #
POLARIS		
1000S Scrambler/Sportsman XP 20-23	1831-1053	-
SEGWAY		
Villain SX10 22-23	-	1831-1051

SINGLE SLIP-ON EXHAUST FOR CAN-AM RENAGADE G2/XMR 1000 12-23

- Built and assembled in northern Sweden
- Can and tube are SS304 stainless steel
- All aluminum parts are CNC-machined from 6061 billet
- Precision TIG-welded with high-quality filler rod; mandrel-bent tubing
- Great power increase
- Spark arrestor included

NOTE: All exhausts and mufflers are bolt-on and are made to fit stock vehicles; any aftermarket modifications or additions may affect exhaust fit



APX EXHAUST

- All aluminum modular exhaust
- CNC-machined brackets on all critical points
- CAD drawn with extruded aluminum can
- Casted stainless intake flanges and new inner core

DESCRIPTION	PART #
Single slip-on APX exhaust	1831-1054

EL'COMANDANTE TUNER

- Helps optimize engine performance and prevent damage; running with a lean fuel mixture can cause severe engine damage
- Ensures the correct air-to-fuel mixture when modifying or adding additional components to your vehicle
- Works with any RJWC exhaust system
- Includes cable

FITS MODEL	PART #
CAN-AM	
Outlander/Renegade G2 17-23	1020-4039
CFMOTO	
800/850 CForce 16-23	1020-4040
950/1000 Zforce (not HO) 20-23	1020-4041
950 ZForce HO EFI 4x4 23	1020-4042



1020-4039

FITS MODEL	PART #
POLARIS	
850/1000 Scrambler 15-23	1020-4040
850 Sportsman 16-23, 1000 Sportsman 21-23	1020-4040
SEGWAY	
570/600 Snarler 21-23	1020-4043
Villain 21-23	1020-4042



1811-4446



1861-1679

ARROW
EXHAUST

URBAN MUFFLER FOR VESPA

- Race-Tech diamond shape with a shorter silencer
- Re-engineered interiors with a new silencing system
- Swingarm mounts are welded to the silencer body, eliminating the adapting plate
- Made in stainless steel

FITS MODEL	TAILPIPE/MUFFLER/END CAP TYPE	PART #
VESPA		
GTS125 i.e. 21-23	Black/black/carbon fiber	1811-4446
	Catalytic converter insert	1861-1679

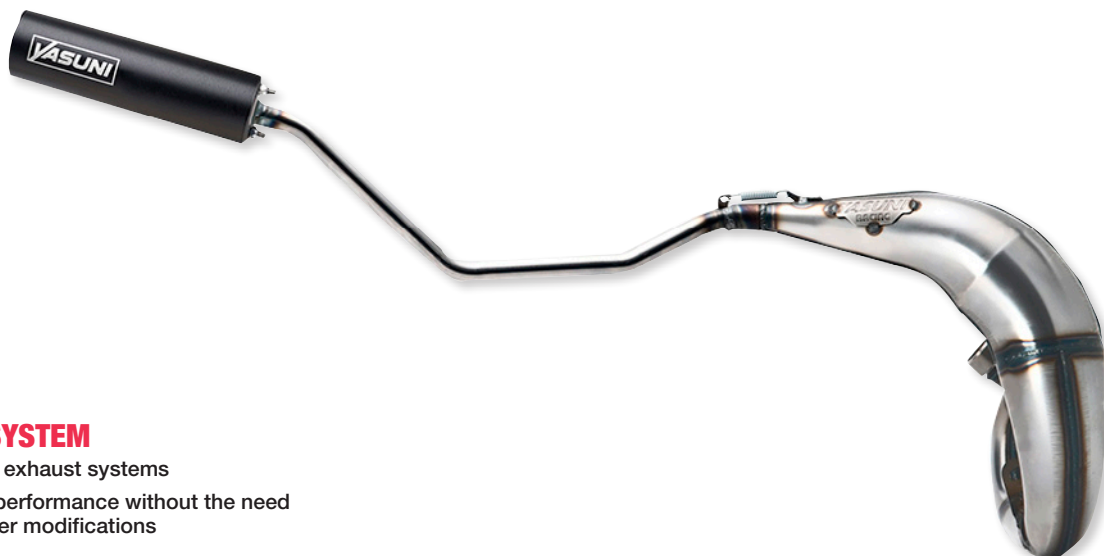

GLOSS BLACK

YASUNI

PERFORMANCE EXHAUST TECHNOLOGY

CROSS ML EXHAUST SYSTEM

- Motocross/dual-sport style exhaust systems
- Provides improved engine performance without the need for additional engine/cylinder modifications
- Gloss black muffler sleeve

FITS MODEL	PART #
SHERCO	
50 SE-R / SE-RS / SM-R / SM-RS	1810-3120



**REAR DOOR BAGS
FOR CAN-AM MAVERICK X3 17-20**

- Sold as a pair (left and right)
- Front knee pad
- One large zippered storage area
- Mount using front factory door holes and included fasteners

DESCRIPTION	PART #
Rear door bags	3540-0072



0822-0520



0822-0521



0822-0522

**KALIBER ARMREST PADS
FOR POLARIS SLINGSHOT 15-22**

- Driver and passenger armrest pads
- Feature 44 mm (1³/₄") foam for comfort
- Mount with dual hook-and-loop adhesive strips for easy installation and removal
- Marine grade vinyl for durability, fade prevention and cold crack control
- Measure 53,5 cm L (21")
- Sold in pairs



COLOR	PART #	COLOR	PART #	COLOR	PART #
Black	0822-0520	Blue	0822-0521	Red	0822-0522



0521-2029



0521-2030



**KALIBER SEAT BELT COVERS
FOR POLARIS SLINGSHOT 15-23**

- Add style and a touch of flare to the Slingshot's bare seat belt buckles
- They install in seconds with a zipper and hold snug in place
- Covers the outside of the buckle and cable that ensures your safety as your ride with your community
- Hand-stitched, marine grade vinyl for durability, fade prevention and cold weather crack protection



0521-2031

COLOR	PART #	COLOR	PART #	COLOR	PART #
Black	0521-2029	Blue	0521-2030	Red	0521-2031

SHOW CHROME®



KALIBER PASSENGER GRAB HANDLE COVERS FOR POLARIS SLINGSHOT 15-23

- Hand-stitched, marine grade vinyl for durability, fade prevention and cold weather crack protection
- Install in seconds with a zipper and holds snugly in place

COLOR	PART #	COLOR	PART #	COLOR	PART #
Black	0521-2026	Blue	0521-2027	Red	0521-2028



KALIBER E-BRAKE HANDLE COVERS FOR POLARIS SLINGSHOT 20-23

- Add a refined look and luxury feel for your e-brake
- Easy zipper installation with peel and stick hook-and-loop style adhesive for added security
- Hand-stitched, marine grade vinyl for durability, fade prevention and cold weather crack protection

COLOR	PART #	COLOR	PART #	COLOR	PART #
Black	0521-2032	Blue	0521-2033	Red	0521-2034

TURN SIGNAL LEVER EXTENDER FOR POLARIS SLINGSHOT 15-23

- Easy to install with included double-sided tape
- Sold each

DESCRIPTION	PART #
Turn signal lever extender	0521-2035



OEM REPLACEMENT MIRRORS

- OEM replacement mirrors at reasonable prices
- Mount and look like the originals



FITS MODEL	SIDE	PART #
ECE APPROVED		
HONDA		
CRF1000L Africa Twin 16-19	R.H.	0640-1570
	L.H.	0640-1569
KAWASAKI		
EN650 Vulcan 16-21	R.H.	0640-1560
	L.H.	0640-1559
VN900 Classic/Classic LT 14-21	R.H.	0640-1562
	L.H.	0640-1561
VN900 Custom 14-21	R.H.	0640-1563
	L.H.	0640-1564
VN1700 Classic 09-13/Classic LT 09-10/Nomad LT 09-14/Vaquero 11-19/Voyager 09-21	R.H.	0640-1566
	L.H.	0640-1565

FITS MODEL	SIDE	PART #
KAWASAKI (CONT)		
VN2000 Limited 04-09/VN2000 Classic LT 06-10	R.H.	0640-1566
	L.H.	0640-1565
SUZUKI		
SV650 17-19	R.H.	0640-1572
	L.H.	0640-1571
GSX-S1000 16-20	R.H.	0640-1572
	L.H.	0640-1571
NON-ECE APPROVED		
YAMAHA		
YZF-R1/R1M 15-19	R.H.	0640-1568
	L.H.	0640-1567



LEGEND GEAR SIDE BAG SYSTEMS

- Vintage, lightweight soft luggage design with modern support
- Coated canvas sailing material and robust synthetic leather reinforce the bags' structure
- Fiber-reinforced polyamide quick-lock system provides fast and reliable attachment and removal of the bags
- LC1 dimensions: 26 cm H x 31 cm W x 14 cm D (10¹/₄" x 12¹/₄" x 5¹/₂"); 9,8 liter carrying capacity
- Include a pair of side bags, two waterproof inner bags, two SLC side carriers and all required mounting hardware

3501-1979



ADAPTER KIT FOR PRO SIDE CARRIERS

- Allows you to mount side bags with the SLC mount to a PRO side carrier

ADAPTER KITS

DESCRIPTION	PART #
Adapter kit for SLC side bags on PRO side carrier	3501-1977

LC1 SIDE BAGS

FITS MODEL	COLOR	PART #
KAWASAKI		
Z900RS/Cafe/50th Anniversary Edition 17-23	Black	3501-1978
ROYAL ENFIELD		
Meteor 19-22	Black	3501-1979
TRIUMPH		
Scrambler 05-16	Black	3501-1980

SLC SIDE CARRIERS

- Allows for simple and secure mounting on the bike's original attachment points
- Quick-release mounting system allows side bags to be easily attached or removed
- Provides secure hold for side bags, side cases, adapter plates and universal side bracket number plates
- Available for both the left and right sides of the motorcycle
- Includes mounting hardware



1510-1124



DESCRIPTION	RIGHT PART #	LEFT PART #
DUCATI		
Desert X 22-23	1510-1124	1510-1125
HONDA		
CB750 Hornet 22-23	1510-1131	1510-1132
KAWASAKI		
Z650RS (incl. 50th Anniversary Edition) 21-23	1510-1127	1510-1128
YAMAHA		
XSR900 21-23	1510-1122	1510-1121

ION TANK RING

FOR SUZUKI GSX1300R HAYABUSA 20-23

- Allows mounting of ION tank bags
- Convenient quick-lock mechanism allows the tank bag to be mounted or removed in seconds
- Bike-specific design provides complete stability and optimal fit
- Simple installation
- Constructed from fiberglass-reinforced polyamide
- Mounting hardware included

DESCRIPTION	PART #
Ion tank ring	0510-0639

STREET RACKS

- Compact design is perfectly suited for sport bikes and smaller street bikes
- Constructed of 5 mm-thick aluminum alloy
- Simple assembly on the original mounting points
- Adapter plates require no tools for mounting and can be removed in seconds
- Adapter plates include kit for noted top case mounting
- Black powdercoated finish

STREET RACKS

FITS MODEL	PART #
HONDA	
CB750 Hornet 22-23	1510-1130
KAWASAKI	
Z650RS (including 50th Anniversary Edition) 21-23	1510-1129



1510-1134

ADAPTER KIT

DESCRIPTION	PART #
Black adapter plate for Givi/Kappa top cases with Monokey	1510-1134

FITS MODEL	PART #
YAMAHA	
XJR1200 95-99	1510-1133
XJR1300 98-14	1510-1133



CENTERSTANDS

- Bike-specific design allows for easy mounting and a high-cornering clearance
- Easily lifts up motorcycle
- Highly corrosion-resistant
- Ideal for keeping the load off the tires during long periods of storage
- Black powdercoated surface
- Mounting hardware included

FITS MODEL	PART #
KAWASAKI	
KLV1000 03-05	0510-0641



FITS MODEL	PART #
SUZUKI	
DL1000 V-Strom 01-07	0510-0641

CRASH BARS

- Offer reliable protection for important components
- Model-specific design fits seamlessly with the lines of the bike and provide optimal cornering clearance
- No modifications needed for mounting
- Black powdercoated finish
- Match the look and feel of the motorcycle
- 27 mm diameter
- Sold in pairs
- Include mounting hardware and instructions

FITS MODEL	PART #
DUCATI	
Desert X 22-23	0505-2370
TRIUMPH	
Tiger 1200 GT/GT Explorer/GT Pro 22-23	0505-2360¹



FITS MODEL	PART #
YAMAHA	
Tenere 700 World Raid 22-23	0505-2359

¹ Upper crash bar.

CYLINDER GUARDS FOR BMW R1200R 12-18

- Protect cylinder valve covers against falls and slides
- Specially adapted to the shape of the valve cover
- Laser-cut brushed aluminum frame
- Include two cylinder protectors, mounting hardware and instructions



DESCRIPTION	PART #
Cylinder guards	0506-1948



ENGINE GUARD

FOR MOTO GUZZI V100 MANDELLO/S 22-23

- Provides additional protection against rocks and contact with the ground
- High-quality aluminum alloy construction
- Secure fit doesn't affect ground clearance
- Easy installation on frame mounting points
- Also protects header and exhaust parts
- Cutouts allow access to oil drain screws

DESCRIPTION	PART #
Silver engine guard	0506-1955



FRAME SLIDER SET

FOR YAMAHA MT-10/SP 21-23

- Offers maximum protection for important motorcycle parts
- Constructed from abrasion-resistant plastic
- Slider pads are made with lightweight PA6-MO that offers high tensile strength and significant impact- and UV-resistance
- Worn pads can be easily swapped out; replacement pads sold separately
- Simple installation
- Include two sliders, mounting hardware and instructions

DESCRIPTION	PART #
Frame slider set	0505-2358



BAR RISERS

FOR TRIUMPH TIGER 1200 22-23

- Change the seating position to enhance rider comfort
- Constructed from high-strength aluminum alloy
- Available in +30 mm taller than stock height
- Do not require extending the original cables
- Sold in pairs

RISER HEIGHT	PART #
Silver bar risers (+ 30 mm)	0602-1435



ION FOOTREST KIT

FOR TRIUMPH TIGER 1200 GT/GT EXPLORER/ GT PRO/RALLY EXPLORER/RALLY PRO 22-23

- Easily mounted on original footrest mount
- Made from high-quality, corrosion-resistant cast stainless steel
- Removable rubber top surface
- Installs at original height or 15 mm lower
- Profiled, anti-slip surface texture
- Large contact surface
- Includes two footrests, two hinge adapters and mounting hardware
- Footrests only also available

DESCRIPTION	PART #
Ion footrest kit	1620-2478

GEAR LEVERS

- Modern, two-piece design and constructed with CNC-milled aluminum
- Spring mechanism enables lever to be folded down and protects it in case of a crash
- Can be adjusted 1 cm, 2 cm or 3 cm beyond the original position
- Scratch resistant

FITS MODEL	PART #
DUCATI	
Multistrada 950 18-20	1620-2481
Multistrada V2 21-23	1620-2481
Multistrada 1260 17-23	1620-2481

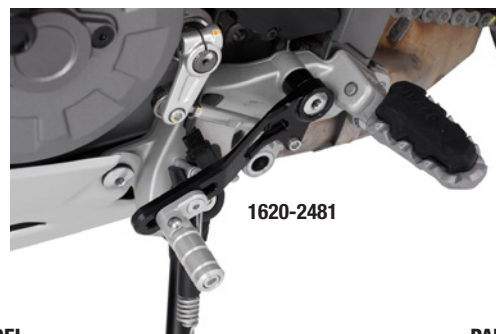

FITS MODEL	PART #
HONDA	
CFR1000L 15-18	1620-2482
CFR1100L 19-22	1620-2482



LIGHT MOUNTING KIT FOR HONDA VFR1200X CROSSTOURER 11-21

- Compatible with SW-Motech lights
- Easy installation
- Black powdercoated finish
- Includes mounting hardware



DESCRIPTION	PART #
Light mount kit	2001-2680



ART®
4
0
0
0

CLASSE
S.R.A.

XTREM MAXI SECURITY LOCKS

- Reversible shackle ø 18 mm in passivated hardened steel shackle protection sheath in matt black finish
- Hardened steel body
- Double locking mechanism in hardened steel
- High security cylinder with 7 discs anti-sawing, anti-picking cylinder anti-rotation device of the shackle in case of sawing ABS end caps and keyway with dust cover
- Delivered with 3 milled keys



DESCRIPTION	PART #	DESCRIPTION	PART #
110 x 230 mm	4010-0466	110 x 310 mm	4010-0467



ART®
4
0
0
0

CLASSE
S.R.A.

XTREM PROTECT CHAIN LOCKS

- Tempered passivated steel chain diameter 13,5 mm with chain block anchor
- Special off-road safety
- Protective sheath in black braided nylon
- Blocking block in HR stainless steel
- Double hardened steel locking mechanism
- High security cylinder with 7 discs
- Anti-sawing, anti-picking
- Two M10 stainless steel dowels for high security anchoring



DESCRIPTION	PART #	DESCRIPTION	PART #
1,0 meter	4010-0464	1,2 meter	4010-0465

REAR STAND PIN FOR HONDA CB 1000 R 18-20

- Pin holder bush houses two ball bearings allowing for rotation of the lifting pin
- Pin stand is fixed on a bearing and is specific to your motorcycle's model
- Measures 18.1 mm in diameter
- Fits RS-16 single-sided swingarm stand; see page 357 of the 2023 Parts Europe Street catalog

Bike-Lift®



DESCRIPTION	PART #
Rear stand pin	4110-0196



**DYNAMIC LED FAIRING VENT INSERTS
FOR 19-23 CHIEFTAIN/CHIEFTAIN LIMITED/CHIEFTAIN
DARK HORSE/CHIEFTAIN ELITE/ROADMASTER
DARK HORSE, 21-23 ROADMASTER LIMITED**

- Replaces fairing vent OEM #5454864 with built-in white running light and auxiliary amber turn signals
- Dual-color amber/white LEDs
- Decorative stainless mesh
- Includes plug-and-play connectors for simple installation behind fairing
- Mounts using factory hardware
- Does not block airflow from OEM vent



2040-3027



2040-3028

DESCRIPTION	PART #
Black	2040-3027

DESCRIPTION	PART #
Chrome	2040-3028



DUAL INTENSITY SIDE FIRING AUXILIARY LED STRIPS

- Flexible, low-profile auxiliary LED strips designed to mount under the rear fender edge
- 78 dual-intensity red LEDs per strip are placed at a 90° angle to shine towards the rear
- Each strip is 25" long with 5' wire leads to route under the seat for connections for low intensity power (run), high intensity power (brake, turn signal or brake/turn) and ground
- LED strips can be cut every 6 LEDs or 1,95" to customize length for an exact fit to the rear fender
- 0,310" mounting surface; 0,094" thick
- Current draw at 12,8V per 6 LEDs: 14mA run, 38mA brake; current draw at 14,4V per 6 LEDs: 16mA run, 48mA brake
- Universal design, 3-wire installation
- Sold in pairs; pre-taped for mounting



DESCRIPTION	PART #
Flexible light strips	2040-3022



2020-2148



2020-2149

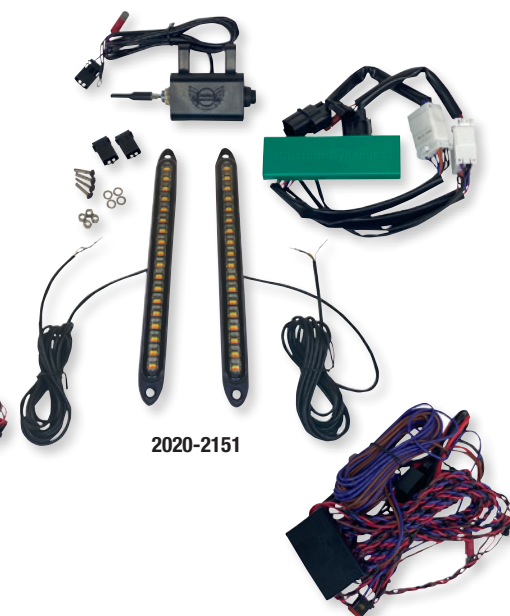

2020-2151

LED TURN SIGNAL KIT

- Four 31,75 mm (1,25") amber LED turn signals
- Four-way hazard flasher and switch
- Turn signal flasher and switch
- Two green LED turn signal indicators
- Complete easy to install wiring harness with fuse and switches
- Universal, works on all 12VDC systems

ATV/UTV

DESCRIPTION	PART #
HONDA	
Talon 1000 R/X-4 19-21	2020-2151
POLARIS	
RZR XP 1000/4 XP 17-18	2020-2149

UNIVERSAL

DESCRIPTION	PART #
Front turn signal	2020-2148

DESCRIPTION	PART #
POLARIS (CONT)	
RZR XP 1000/4 15-17 XP 1000 15-18, 900 4x4 15-19, S900 15-20, 4/XP 1000/Turbo 16-18, S 1000 16-20, XP Turbo/S4/4 XP 18, S 900 Premium 20	2020-2150



ATV TRAILERABLE COVERS

- Innovative UltraMax® durable polyester material
- Highest UV protection in the industry
- Water-resistant coating helps protect against light rain, dust and dirt
- Two heavy-duty quick-adjustable straps and side-release buckles hold the cover on
- Four tie-down locations allow for extra security
- Packed in multi-use carry bag for compact storage
- Elastic hem secures cover to ATV
- Available in X-large and XX-large

DESCRIPTION	PART #	DESCRIPTION	PART #
X-large	4002-0101	XX-large	4002-0102

DIMENSIONS

SIZE	LENGTH	FRONT WIDTH	BACK WIDTH	TOP WIDTH	HEIGHT
X-large	208 cm (82")	117 cm (46")	112 cm (44")	79 cm (31")	103 cm (40,5")
XX-large	267 cm (105")	127 cm (50")	127 cm (50")	84 cm (33")	126 cm (49,5")



4002-0101

ATV DURA COVERS

- Innovative UltraMax® durable polyester material
- Highest UV protection in the industry
- Water-resistant coating helps protect against light rain, dust and dirt
- Packed in multi-use carry bag for compact storage
- Elastic hem secures cover to ATV
- Not trailerable
- Available in X-large and XX-large

DESCRIPTION	PART #	DESCRIPTION	PART #
X-large	4002-0099	XX-large	4002-0100

DIMENSIONS

SIZE	LENGTH	FRONT WIDTH	BACK WIDTH	TOP WIDTH	HEIGHT
X-large	214,6 cm (84,5")	122 cm (48")	119 cm (47")	79 cm (31")	103 cm (40,5")
XX-large	267 cm (105")	127 cm (50")	127 cm (50")	84 cm (33")	126 cm (49,5")



4002-0099

UTV COVERS

- Innovative UltraMax® durable polyester material
- Highest UV protection in the industry
- Water-resistant coating helps protect against light rain, dust and dirt
- Perma-vent® system minimizes condensation and allows for airflow
- Large driver-side zipper entry access to vehicle when covered
- Packed in multi-use carry bag for compact storage
- Snug elastic hem secures cover to UTV
- Not trailerable

DESCRIPTION	PART #	DESCRIPTION	PART #
2-Seater	4002-0103	4-Seater	4002-0104

DIMENSIONS

SIZE	LENGTH	FRONT WIDTH	BACK WIDTH	TOP WIDTH	HEIGHT
2-Seater	333 cm (131")	151 cm (59,5")	148,5 cm (58,5")	120,5 cm (47,5")	173 cm (68")
4-Seater	376 cm (148")	174 cm (68,5")	174 cm (68,5")	123 cm (48,5")	175 cm (69")



4002-0103





151 LITER (40 US GAL.) SPOT SPRAYER

- 151 liter (40 US gal.) corrosion-resistant polyethylene tank
- 12V diaphragm 0,1 LPS (2,1 GPM) high-flo pump
- 4,1 bar (60 psi) max
- 244 cm (8') wire harness with clips and on/off switch
- Poly clips for handgun storage
- Deluxe handgun with adjustable pattern tip and 4,6 m (15') of hose
- Maximum horizontal throw – 10,7 m (35')
- Maximum vertical throw – 7,6 m (25')
- Ready for immediate use

NOTE: Will not work with any sprayer boom.

DESCRIPTION	PART #
151 liter spot sprayer	4503-0063

95 LITER (25 US GAL.) SPRAYER W/ 7,9 LPM (2,1 GPM) PUMP

- 95 liter (25 US gal.) corrosion-resistant poly tank
- Full drain-out capability with molded-in drain port, cap and tether
- 12,5 cm (5") fill lid with tether
- Larger hose wrap horns for hose storage
- Both gallon and liter fluid volume indicator on tank; molded wand clips
- 45,5 cm (18") lever hand wand with adjustable pattern tip
- 4,6 m (15') hand wand hose
- Maximum horizontal throw 9,1 m (30')
- Max vertical throw 5,5 m (18')
- Must use with straps or tie-downs

DESCRIPTION	PART #
7,9 LPM (2,1 GPM) sprayer	4503-0048

MOOSE SPRAYER REPLACEMENT PUMP

- Sold each

DESCRIPTION	PART #
17 LPM (4,5 GPM) repl. pump	4503-0130



FRONT ALUMINUM ATV BOX

- Gas-mounted shock improves box access and noise reduction while on the trail
- Weather stripping added to lid reduces noise and provides additional protection from the elements
- Rugged diamond plate aluminum construction is rust-resistant and more durable than plastic or cloth
- Attractive black powdercoated finish resists cracking and fading while minimizing reflection from the sun
- Black stainless steel latches with double post hooks provide extra security
- Drain and ventilation holes provide air circulation and easy cleaning
- Mount kit included for easy, secure attachment
- Dimensions: 81 cm L x 32,5 cm W x 16 cm H (32" x 12,75" x 6,25")
- Include anti-slip/protective mat and lockable latches with two keys



DESCRIPTION	PART #
Front aluminum ATV vox	3505-0047



TWO TIER REAR STORAGE TRUNK

- Perfect for storing all of your supplies and riding gear
- Top level is perfect for smaller items and the bottom level will accommodate larger gear
- Complete with two padlockable latches
- Double-wall lids provide maximum rigidity
- Single-wall body allows for maximum storage capacity
- Rugged roto-molded design
- Dimensions: 94 cm W x 42,5 cm D x 42,5 cm H (37,0" x 16,75" x 16,75")

DESCRIPTION

Two tier rear storage trunk

PART

3505-0208



REAR STORAGE BOX

- Perfect for storing all of your supplies and riding gear
- Large storage area can accommodate two XL helmets with room to spare
- More than 85 liter (3 cubic feet) of storage space
- Complete with two key-lockable latches
- Double-wall lid provides maximum rigidity
- Single-wall body allows for maximum storage capacity
- Features a weather-resistant seal to keep your gear dry
- Rugged roto-molded design
- Dimensions: 94 cm W x 44 cm D x 34,5 cm H (37,0" x 17,3" x 13,6")



DESCRIPTION

Rear storage box

PART

3505-0210



RZR BED TOPPER

- Durable polyethylene with UV stabilizers
- Fits all Polaris RZR 800 08-14 two- and four-passenger vehicles (except RZR S 09-10 models)

DESCRIPTION	PART #
Bed topper	0521-0993



0521-0867



0521-0994

ROOFS

ONE-PIECE ROOFS

- Durable polyethylene with UV stabilizers
- Extremely durable in cold weather
- Molded-in cargo tray allows for extra storage
- Molded-in drains allow water to run off from storage area
- Must remove for trailering

TWO-PIECE ROOFS

- Durable polyethylene with UV stabilizers
- Extremely durable in cold weather
- Come with all necessary mounting hardware
- Must remove for trailering

FITS MODEL	SIZE	STYLE	PART #
KAWASAKI			
Teryx 750 08-11	76 cm L x 150 cm W x 12,5 cm H (30" x 59" x 5")	1 Piece	0521-0867
POLARIS			
Ranger 570 Full-Size 16-19	89 cm L x 159 cm W x 95,25 mm H (35" x 62,5" x 3,75")	2 Piece	0521-0994
Ranger Full-Size 10-12	89 cm L x 159 cm W x 95,25 mm H (35" x 62,5" x 3,75")	2 Piece	0521-0994
Ranger Diesel 11-14	89 cm L x 159 cm W x 95,25 mm H (35" x 62,5" x 3,75")	2 Piece	0521-0994
Ranger 6x6 Full-Size 16-19	89 cm L x 159 cm W x 95,25 mm H (35" x 62,5" x 3,75")	2 Piece	0521-0994
YAMAHA			
Rhino 04-12 (all)	76 cm L x 150 cm W x 12,5 cm H (30" x 59" x 5")	1 Piece	0521-0867



2317-0462



2317-0464

DELUXE FULL FOLDING WINDSHIELDS

- Provides full windshield protection with the option to fold down the middle part of the windshield to allow for better air flow and/or visibility
- It is designed to work with the OEM roof while not leaving a large gap between the top of the windshield and roof
- The windshield is attached to the roll cage using four profile clamps

- The middle section of the windshield is attached using three hinges with a unique fold to prevent water intrusion at the hinge line
- The top of the folding part of the windshield is connected to the roll cage with two hook-and-loop straps
- Made from 4,5 mm (0,177") polycarbonate

FITS MODEL	PART #	OVERALL WIDTH	OVERALL HEIGHT
CAN-AM			
Traxter - HD 5, HD 8, HD 10, Limited HD, Pro HD, Max HD 16-22	2317-0462	130 cm (51")	76 cm (30")
Commander & Max 11-20	2317-0464	135 cm (53")	79 cm (31")



FULL WINDSHIELD FOR CAN-AM MAVERICK 13-18

- Made from 4,5 mm (0,177") thick clear polycarbonate
- Mounts to roll bar using stainless steel rubber-coated mount straps
- Protect yourself from the elements
- Features rubber trim at bottom of shield to help keep elements out



OVERALL WIDTH	OVERALL HEIGHT	PART #
CAN-AM		
131,4 cm (51,75")	70,5 cm (29,75")	2317-0322



TRI-FOLD ADJUSTABLE RAMP

- Tri-fold aluminum ramp is strong and lightweight
- Unit is adjustable from 107 cm to 132 cm (42" to 52")
- 566 kg (1250 lb) distributed loading capacity
- Bar-style surface for better traction
- Comes with E-Z grip rubber truckrests and nylon straps

WARNING: Do not ride ATV on ramp at any time.

DIMENSIONS	PART #
107 cm-132 cm x 193 cm (42"-52" x 76")	3910-0008

01 PERMANENT BATTERY LEAD

- Weatherproof cap
- -40°C/-40°F very low temperature use; cable remains flexible at 'below freezing' temperatures
- Molded ringlets
- Will work with Moose Utility Division OptiMate 3 and OptiMate 6 battery chargers
- Available individually, in a jar of 20



DESCRIPTION	PART #
Jar of 20 01 permanent battery leads	3807-0536



ZEBRA SEAT COVERS

- Excellent non-slip performance and durability
- Aggressive, up-to-date look

FITS MODEL	COLOR	PART #
HONDA		
CRF250 22-23	Red top/black sides/black ribs	0821-3525
CRF450 21-23	Red top/black sides/black ribs	0821-3525
HUSQVARNA		
TC 85 23	Yellow top/black sides/black ribs	0821-3555
FC/TC 23	Black top/black sides/yellow ribs	0821-3557

FITS MODEL	COLOR	PART #
KTM		
SX/SX-F 23	Black top/orange sides/orange ribs	0821-3554
YAMAHA		
YZ125/250 22-23	Blue top/black sides/black ribs	0821-3526
YZ125/250 22-23	Black top/blue sides/blue ribs	0821-3549
YZ250F 19-23	Black/blue	0821-3530
YZ450F 23	Blue top/black sides/black ribs	0821-3532

DOUBLE GRIP 3 SEAT COVERS

- Innovative strip system, and ultra-resistant, excellent grip materials
- Raised strips specifically designed to allow riders to shift their weight directly onto the back wheel
- Excellent shock resistance



FITS MODEL	COLOR	PART #
HUSQVARNA		
FC/TC 23	Black/yellow	0821-3540
KTM		
SX/SX-F 23	Black/orange	0821-3539

FITS MODEL	COLOR	PART #
TM		
MX-EN 2-stroke 15-21	Teal/white	0821-3550
YAMAHA		
YZ125/250 22-23	Black/blue	0821-3548
YZ450F 23	Black/blue	0821-3529

PYRAMID SEAT COVERS

- New-generation anti-slip effect, made in material with excellent grip and a rubbery consistency that gives the rider perfect adherence to the seat in all conditions
- Excellent wear resistance
- Easy to apply, shaped parts specially studied to fit the shape of the seat



FITS MODEL	COLOR	PART #
BETA		
RR 2T/4T 20-23	Blue	0821-3541
	Black	0821-3552
GAS GAS		
EC 125/250/300 02-06	Black	0821-3551
FSE 450 02-06	Black	0821-3551
HUSQVARNA		
FC/TC 23	Black	0821-3556
KAWASAKI		
KX250F 21-23	Black	0821-3546

FITS MODEL	COLOR	PART #
KAWASAKI (CONT)		
KX450F 19-23	Black	0821-3546
KTM		
SX/SX-F 23	Black	0821-3538
	Orange	0821-3553
YAMAHA		
YZ125/250 22-23	Black	0821-3547
YZ450F 23	Black	0821-3527
	Blue	0821-3528



SEAT FOAMS

- Made of waterproof polyurethane foam and perfectly interchangeable with the original
- Provides greater stiffness and speeds up the rider by shifting to balance the weight



0811-0271

FITS MODEL	DESCRIPTION	PART #
HUSQVARNA		
FC/TC 23	Standard	0811-0271
	+15 mm	0811-0270
KTM		
SX/SX-F 23	Standard	0811-0269
	+15 mm	0811-0268

FITS MODEL	DESCRIPTION	PART #
YAMAHA		
YZ125/250 22-23	Standard	0811-0272
	+15 mm	0811-0273
YZ450F 23	Standard	0811-0267
	+15 mm	0811-0266



0821-3543



0821-3542



0821-3544

TRADITIONAL SEAT COVERS

- Designed to directly replace the original seat cover
- Perfectly shaped to the seat
- Non-slip construction
- Moon design allows for foams of up to 2 cm

FITS MODEL	PART #	FITS MODEL	PART #	FITS MODEL	PART #
HONDA		HONDA (CONT)		HONDA (CONT)	
XR 250/400 96-04	0821-3543	Dominator (all)	0821-3542	Transalp 88-99	0821-3544



ORIGINAL GRAPHIC KIT WITH SEAT COVER

FOR HONDA XR250-400 96-04

- Includes tank graphics, front fender side graphics and matching seat cover



DESCRIPTION	PART #
Graphic kit with seat cover	4302-7001



0821-3524

REPLICA TEAM HRC 50TH ANNIVERSARY 2021 GRAPHIC KIT AND SEAT COVER

- Graphic kits include radiator shrouds, front fender, rear fender, airbox, fork protectors and swingarm graphics (number plate backgrounds not included)
- Seat covers feature a customized seat area that provides better traction by using risers, extra grip and anti-slip positioning

FITS MODEL	GRAPHIC KIT	SEAT COVER
HONDA		
CRF250 22-23	4302-6977	0821-3524
CRF450 21-23	4302-6977	0821-3524



**RETRO GRAPHIC KIT
FOR HONDA CRF250 22-23, CRF450 21-23**

- Includes radiator shroud, airbox, fork protectors, swingarm, front fender, rear fender and number plate graphics

DESCRIPTION	PART #
Graphic kits	4302-6976



**RETRO GRAPHIC KITS AND GRAPHIC
KITS WITH SEAT COVERS
FOR HUSQVARNA FC/TC 23**

- Graphic kits include radiator shrouds, front fender and rear fender stickers
- Graphic kits with seat covers include radiator shrouds graphics, front fender stickers and rear fender stickers

DESCRIPTION	PART #
Graphic kit	4302-6987
Graphic kit w/ seat cover	4302-6998



**DREAM 4 GRAPHIC KIT AND GRAPHIC
KIT WITH SEAT COVER
FOR HUSQVARNA FC/TC 23**

- Graphic kit includes radiator shrouds, front fender and rear fender stickers
- Graphic kit with seat cover includes radiator shrouds graphics, front fender stickers and rear fender stickers

DESCRIPTION	PART #
Graphic kit	4302-6988
Graphic kit w/ seat cover	4302-6999



SWINGARM STICKERS FOR HUSQVARNA FC/TC 23

- Sold in pairs

FITS MODEL

Swingarm stickers

PART #

2320-0280

DREAM 4 FORK GUARD STICKERS FOR HUSQVARNA FC/TC 23

- Sold in pairs



DESCRIPTION

Fork guard stickers

PART #

4302-7004

BLUE MOON SEAT COVER FOR KTM SX/SXF 23

- Distinctive fabric that's both long-lasting and superbly stylish
- Ability to withstand extreme stress and the most punishing race conditions
- Washable
- Available in blue



DESCRIPTION

Seat cover

PART #

0821-3537



4302-6986



4302-6997

MATTE BLACK GRAPHIC KIT AND GRAPHIC KIT WITH SEAT COVER FOR KTM SX/SXF 23

- Graphic kit includes radiator shroud, airbox, fork protector, swingarm, front fender and rear fender graphics
- Graphic kit with seat cover radiator shroud, airbox, fork protector, swingarm, front fender and rear fender graphics

DESCRIPTION

Graphic kit

Graphic kit w/ seat cover

PART #

4302-6986

4302-6997



4302-6994



4302-6984

RETRO GRAPHIC KITS AND GRAPHIC KITS WITH SEAT COVERS

- Graphic kits include radiator shroud, airbox, fork protectors, swingarm, front fender, rear fender and number plate graphics
- Graphic kits with seat covers include radiator shroud, airbox, fork protectors, swingarm, front fender, rear fender and number plate graphics

FITS MODEL

KTM

SX/SXF 23 (purple/teal)

(red/white/blue)

GRAPHIC KITS

4302-6983

4302-6984

GRAPHIC KITS WITH SEAT COVERS

4302-6994

4302-6995



4302-6985

DREAM 4 GRAPHIC KIT AND GRAPHIC KIT WITH SEAT COVER FOR KTM SX/SXF 23

- Graphic kit includes radiator shrouds, front fender and rear fender stickers
- Graphic kit with seat cover includes radiator shrouds graphics, front fender stickers and rear fender stickers



4302-6996

DESCRIPTION	PART #
Graphic kit	4302-6985
Graphic kit w/ seat cover	4302-6996

DREAM 4 FORK GUARD STICKERS FOR KTM SX/SXF 23

- Sold in pairs



PART #

4302-7003

DESCRIPTION
Fork guard stickers

DREAM 4 RAD LOUVER DECALS FOR KTM SX/SXF 23

- Stickers for radiator louvers and radiator cap
- Made of back-printed crystal material
- 0,5 mm thickness
- Precise shapes for easy assembly



DESCRIPTION

Dream 4 rad louver decals

PART #

4302-6975

DREAM 4 PRE-CUT NUMBER PLATE WITH GRAPHICS FOR KTM SX/SXF 23

- Includes front plate, side plates and airbox graphics



DESCRIPTION

Pre-cut number plate w/ graphics

PART #

4310-0975

DREAM 4 GRAPHIC KIT FOR SUZUKI DR-Z400 00-23

- Includes radiator shrouds, front fender and rear fender stickers



DESCRIPTION

Dream 4 graphic kit

PART #

4302-6990



TRADITIONAL SEAT COVER FOR YAMAHA XT660 04-19

- Designed to directly replace the original seat cover
- Perfectly shaped to the seat
- Non-slip construction
- Moon design allows for foams of up to 2 cm

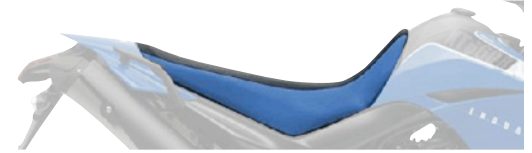

DESCRIPTION	PART #
Traditional seat cover	0821-3545



4302-6978



4302-6991

RETRO GRAPHIC KIT AND GRAPHIC KIT WITH SEAT COVER FOR YAMAHA YZ450F 23

- Graphic kit includes radiator shroud, airbox, fork protectors, swingarm, front fender, rear fender and number plate graphics
- Graphic kit with seat cover includes radiator shroud, airbox, fork protectors, swingarm, front fender, rear fender and number plate graphics

DESCRIPTION	PART #
Graphic kit	4302-6978
Graphic kit w/ seat cover	4302-6991

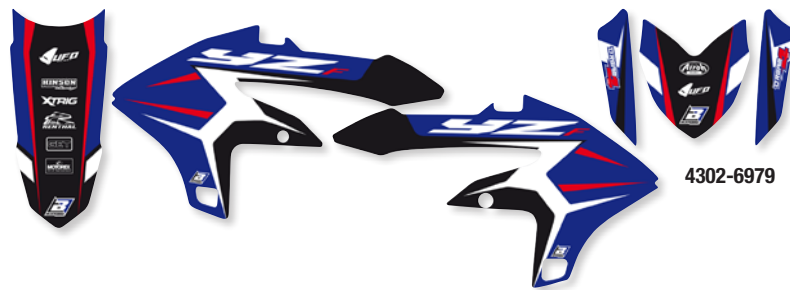

4302-6979



4302-6992

DREAM 4 GRAPHIC KIT AND GRAPHIC KIT WITH SEAT COVER FOR YAMAHA YZ450F 23

- Graphic kit includes radiator shrouds, front fender and rear fender stickers
- Graphic kit with seat cover includes radiator shrouds graphics, front fender stickers and rear fender stickers

DESCRIPTION	PART #
Graphic kit	4302-6979
Graphic kit w/ seat cover	4302-6992

DREAM 4 FORK GUARD STICKERS FOR YAMAHA YZ450F 23

- Sold in pairs



DESCRIPTION	PART #
Fork guard stickers	4302-7002

DREAM 4 PRE-CUT NUMBER PLATE WITH GRAPHICS FOR YAMAHA YZ450F 23

- Includes front plate, side plates and airbox graphics



FITS MODEL	PART #
Pre-cut number plate w/ graphics	4310-0974

RAD LOUVER DECALS FOR YAMAHA YZ450F 23

- Stickers for radiator louvers and radiator cap
- Made of back-printed crystal material
- 0,5 mm thickness
- Precise shapes for easy assembly

DESCRIPTION	PART #
Dream 4 rad louver decals	4302-6974

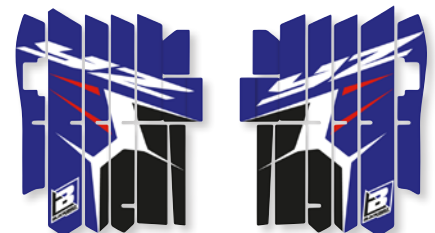



4302-6982



0821-3534



REPLICA TEAM GRAPHIC KITS, SEAT COVERS AND GRAPHIC KIT WITH SEAT COVER

- Graphic kits include radiator shrouds, front fender, rear fender, airbox, fork protectors and swingarm graphics (number plate backgrounds not included)
- Seat covers feature a customized seat area that provides better traction by using risers, extra grip and anti-slip positioning
- Graphic kit with seat cover includes radiator shrouds, front fender, rear fender, airbox, swing-arm, fork protectors, fork stickers, tank stickers (number plate backgrounds not included) and coordinating seat cover

FITS MODEL	GRAPHIC KITS	SEAT COVERS	GRAPHIC KIT WITH SEAT COVER
YAMAHA			
TEAM YAMAHA FACTORY RACING 2022			
YZ450F 23	4302-6980	0821-3531	4302-6993
RALLY RIDE RED			
Tenere 700 20-23	4302-6982	0821-3534 ¹	-
-	-	0821-3536	-
RALLY RIDE BLUE			
Tenere 700 20-23	4302-6981	0821-3533 ¹	-
-	-	0821-3535	-

¹ Two-piece seat cover.

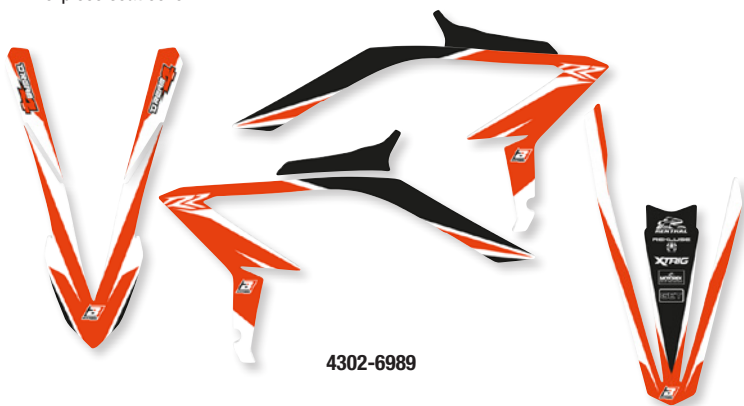

4302-6989



4302-7000

DREAM 4 GRAPHIC KIT AND GRAPHIC KIT WITH SEAT COVER FOR BETA RR 2T/4T 20-23

- Graphic kit include radiator shrouds, front fender and rear fender stickers
- Graphic kit with seat cover include radiator shrouds graphics, front fender stickers and rear fender stickers

DESCRIPTION	PART #
Graphic kit	4302-6989
Graphic kit w/ seat cover	4302-7000

ANTI-MUD FOAM

- Keeps mud from building up on bike parts during wet and sticky trail/track conditions
- Shaped for specific applications



0521-2024



0521-2025

FITS MODEL	PART #	FITS MODEL	PART #	FITS MODEL	PART #
HUSQVARNA		KTM		YAMAHA	
FC/TC 23	0521-2025	SX-SXF 23	0521-2024	YZ450F 23	0521-2023



4302-7047



4302-7049



4302-7034



4302-7036



4302-7036



4302-7042



4302-7046

COMPLETE GRAPHICS KITS

- Includes decals for radiator shrouds, tank, number plate, airbox, lower fork guards, front fender, rear fender and swingarm

FITS MODEL	DESCRIPTION	PART #
GAS GAS		
MC125-450 21-23	GasGas Racing, white background	4302-7047
	GasGas Racing, black background	4302-7048
HUSQVARNA		
TC/FC 125-450 23	Rockstar Husqvarna, black background	4302-7049
	Rockstar Husqvarna, white background	4302-7050
KAWASAKI		
KX85/112 22-23	2023 Monster Energy, black background	4302-7032
KX250 21-23	2023 Monster Energy, black background	4302-7033
KX450F 19-23	2023 Monster Energy, white background	4302-7034
KTM		
250-450 SXF FE 18.5-22, 125-450 SX/SXF 19-22	KTM Racing, black background	4302-7035
	KTM Racing, white background	4302-7036
250-450 SXF FE 22.5-23, 125-450 SX/SXF 23	KTM Racing, black background	4302-7037
	KTM Racing, white background	4302-7038

FITS MODEL	DESCRIPTION	PART #
YAMAHA		
YZ85 22-23	2022-2023 Blue Monster Energy Yamaha, black background	4302-7039
	2023 Star Racing Monster Energy Yamaha, black background	4302-7040
YZ125/250 22-23	2022-2023 Blue Monster Energy Yamaha, white background	4302-7041
	2023 Star Racing Monster Energy Yamaha, white background	4302-7042
YZ250F 19-23	2022-2023 Blue Monster Energy Yamaha, black background	4302-7043
	2023 Star Racing Monster Energy Yamaha, black background	4302-7044
YZ450F 23	2022-2023 Blue Monster Energy Yamaha, black background	4302-7045
	2023 Star Racing Monster Energy Yamaha, black background	4302-7046



4302-7008



4302-7014



4302-7011



4302-7006

DECALS INCLUDED:
COMPATIBLE FOR BOTH 12 AND 16 E-DRIVE MODELS



GRAPHICS KITS

- High-quality motocross graphics
- 15 mil moto material makes your little ripper look like the pros
- Includes all pieces pictured



4302-7009

DESCRIPTION

PART #

12" AND 16" STACYC E-DRIVE MODELS

GasGas	4302-7008
Husqvarna	4302-7005
Purple	4302-7007
Suzuki Army	4302-7006

16" STACYC E-DRIVE BRUSHLESS MODELS

GasGas	4302-7017
Honda HRC	4302-7012
Husqvarna	4302-7014
Kawasaki Monster Energy	4302-7010
KTM	4302-7013
Pink	4302-7011
Purple	4302-7016
Suzuki Army	4302-7015
Yamaha Star Racing	4302-7009

DESCRIPTION

PART #

18" STACYC E-DRIVE MODELS

GasGas	4302-7024
Honda HRC	4302-7018
Husqvarna	4302-7023
Kawasaki Monster Energy	4302-7019
KTM	4302-7020
Suzuki Army	4302-7021
Yamaha Monster Energy	4302-7022

20" STACYC E-DRIVE MODELS

GasGas	4302-7031
Honda HRC	4302-7025
Husqvarna	4302-7030
Kawasaki Monster Energy	4302-7026
KTM	4302-7027
Suzuki Army	4302-7028
Yamaha Monster Energy	4302-7029

UNIVERSAL DECAL SHEETS

- High-quality stickers
- Hi-Tack adhesive
- UV coating
- Available in 12-mil thickness



4320-2550



4320-2549



4320-2547



4320-2548

PRE-CUT FRAME GRIP TAPE FOR YAMAHA YZ450F 23

- Pre-cut to fit model specific applications
- High-strength adhesive
- Aggressive rubberized grip texture

COLOR

PART #

Blue	4320-2548
Gray	4320-2547

DESCRIPTION	PART #
Fridge kit, 12-mil	4320-2550

DESCRIPTION	PART #
Husqvarna Racing, 12-mil	4320-2549



SLA FACTORY-ACTIVATED AGM MAINTENANCE-FREE BATTERIES

- AGM construction (Absorbed Glass Material)
- VRLA battery (Valve Regulated Lead Acid)
- Sealed and Factory-Activated
- Spill-proof design
- Multi-positional fitment
- Ready and easy to use
- Increased power and extended life
- Extreme vibration resistance



2113-0845



2113-0841



2113-0844

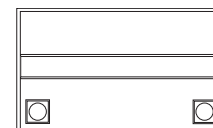

YUASA REFERENCE #	CAPACITY AH (10HR)	CAPACITY AH (20HR)	CCA (EN) A (-18°C)	LENGTH (MM)	WIDTH (MM)	HEIGHT (MM)	APPROX. WEIGHT (KG.)	TERMINAL CONFIGURATION	PART #
6N4-2A/A-4	4	4,2	25	71	71	93	0,75	- +	2113-0845
6N6-3B/B-1	6	6,3	50	95	55	117	1,16	- +	2113-0840
B49-6	10	10,5	80	91	83	159	2,07	+ -	2113-0841
6N11A-1B/3-A	11	11,6	90	121	58	130	1,76	- +	2113-0843
6N11A-4A	11	11,6	90	121	58	130	1,76	+ -	2113-0844
B38-6A	13	13,7	105	119	83	161	2,35	- +	2113-0842



2113-0880



2113-0886



AGM FACTORY-ACTIVATED MAINTENANCE-FREE BATTERIES

- Special absorbed-glass mat battery eliminates water loss
- Truly the world's finest "install it and forget it" motorcycle battery

NOTE: Factory-Activated batteries should be charged once a month when not in service.

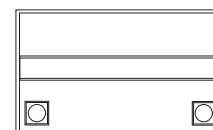

YUASA REFERENCE #	CAPACITY AH (10H-R)	COLD CRANKING AMPS @-18 °C (0 °F)	LENGTH	WIDTH	HEIGHT	APPROX. WEIGHT W/ ACID	TERMINAL CONFIGURATION	PART #
YTX4L	3	50	114 mm (4 ¹ / ₂ ")	71 mm (2 ¹³ / ₁₆ ")	86 mm (3 ³ / ₈ ")	1,5 kg (3,4 lb)	- +	2113-0886
YTZ5S	3,5	65	115 mm (4 ¹ / ₂ ")	72 mm (2 ⁴ / ₅ ")	86 mm (3 ³ / ₈ ")	1,6 kg (3,5 lb)	- +	2113-0889
YTX5L	4	80	115 mm (4 ¹ / ₂ ")	72 mm (2 ⁴ / ₅ ")	107 mm (4 ³ / ₁₆ ")	2,0 kg (4,4 lb)	- +	2113-0881
YTX7A	6	105	152 mm (6")	87 mm (3 ⁷ / ₁₆ ")	95 mm (3 ³ / ₄ ")	2,6 kg (5,7 lb)	+ -	2113-0882
YTX7L	6	100	115 mm (4 ¹ / ₂ ")	72 mm (2 ⁴ / ₅ ")	132 mm (5 ³ / ₁₆ ")	2,5 kg (5,5 lb)	- +	2113-0887
YT7B	6,5	110	152 mm (6")	65 mm (2 ⁹ / ₁₆ ")	93 mm (5 ¹ / ₈ ")	2,7 kg (5,9 lb)	+ -	2113-0883
YT9B	8	120	152 mm (6")	70 mm (2 ³ / ₄ ")	105 mm (4 ¹ / ₈ ")	3,0 kg (6,6 lb)	+ -	2113-0884
YT12A	10	175	152 mm (6")	87 mm (3 ⁷ / ₁₆ ")	105 mm (4 ¹ / ₈ ")	3,5 kg (7,7 lb)	+ -	2113-0879
YT12B	10	210	152 mm (6")	70 mm (2 ³ / ₄ ")	93 mm (3 ¹¹ / ₁₆ ")	4,1 kg (9 lb)	+ -	2113-0880
YT14B	12	210	152 mm (6")	70 mm (2 ³ / ₄ ")	146 mm (5 ³ / ₄ ")	4,6 kg (10,1 lb)	+ -	2113-0890
YTX16	14	230	152 mm (6")	87 mm (3 ⁷ / ₁₆ ")	161 mm (6 ³ / ₈ ")	5,3 kg (11,7 lb)	+ -	2113-0885
YT19B	17,7	170	186 mm (7 ¹ / ₄ ")	82 mm (3 ³ / ₁₆ ")	171 mm (6 ¹¹ / ₁₆ ")	5,7 kg (12,6 lb)	- +	2113-0888

SPARK PLUG RESISTOR COVERS

- Replacement cap for your spark plug
- Waterproof
- 5 ohms resistance
- Allowable wire diameter 7 mm-8 mm



2104-0390



2104-0393

DESCRIPTION	OEM #	PART #
90° ELBOW TYPE		
10/12 mm adaptable thread size, terminal stud, black	8060	2104-0403
10/12/14 mm adaptable thread size, terminal stud, black	8381	2104-0406¹
14 mm adaptable thread size, terminal nut, black	8031/8020	2104-0390
14 mm adaptable thread size, terminal stud, black	8051	2104-0402
120° ELBOW TYPE		
14 mm adaptable thread size, terminal stud, black plastic	8032	2104-0393
10/12 mm adaptable thread size, terminal stud, black plastic	8052	2104-0394
14 mm adaptable thread size, terminal stud, black plastic	8062	2104-0395
10/12 mm adaptable thread size, terminal stud, black plastic	8072	2104-0396
STRAIGHT TYPE		
14 mm adaptable thread size, terminal stud, black	8080	2104-0404
10/12 mm adaptable thread size, terminal stud, black	8022	2104-0405
T TYPE		
14 mm adaptable thread size, terminal nut, red rubber	8955	2104-0391
14 mm adaptable thread size, terminal nut, black rubber	8636	2104-0392

¹ No resistor.



MOMENTARY SWITCH FOR 7/8" HANDLEBARS

- Aluminum body
- Normal position: circuit open; push button: circuit closed
- Wire length: 71,12 cm (28")
- Width: 22,5 mm
- Bolt, nut and lock washer in a black finish
- Includes one pair set of bullet terminal (male and female) and plastic cover in a sealed poly bag
- Wire gauge: AWG 18



DESCRIPTION	PART #
Momentary Switch	2106-0604



STATORS

- OEM-style stators
- Direct plug-in stators complete with all rubbers and OEM-style plug end



FITS MODEL	PART #
HUSQVARNA	
TC50 17-23	2112-1732
KTM	
50 SX (all) 02-23	2112-1732

LITHIUM-ION FRIENDLY CHARGING KITS

- Rick's Motorsport original design
- Includes both a stator and a lithium-ion friendly rectifier-regulator
- Will put out approximately 150 watts and power a 55-watt headlight if the bike's rotor has not been compromised
- Supplies constant power to the bike's battery



NOTE: This kit is not for use with standard lead acid batteries. The voltage point is set to 14V +/- 2.

Please contact the manufacturer of your lithium-ion battery to ensure the product has the correct set point.

FITS MODEL	PART #	FITS MODEL	PART #	FITS MODEL	PART #
HUSQVARNA		KTM (CONT)		KTM (CONT)	
TE 150 17-18	2112-1734	XC-W 125 17	2112-1735	XC 250/300 08-16	2112-1734
TC 250 14	2112-1734	SX 144 07-08	2112-1734	XC-W 250/300 08-11	2112-1734
TE 250/300 14-16	2112-1734	XC-W 150 17-19	2112-1735	XC-W 250/300 12-16	2112-1735
KTM		XC 200 14	2112-1734		
XC 125 21	2112-1734	XC-W 200 13-16	2112-1735		



Machined



Blue



Red

TYPE 387X ATV/UTV WHEELS

- Built to meet the demands of the ATV/UTV market, Moose Utility Division is proud to introduce the 387X line of wheels
- Whether it is in the woods, deep mud or sand, the 387X is prepared to take it on
- All Moose wheels are 100% X-rayed on the production line to ensure quality and reliability
- Handles load capacities from 306 kg (675 lb) for the 12x7 and 14x7 front, to 522 kg (1150 lb) for the 12x8 and 14x8 rear, which meet or exceed all current market requirements
- Available in gloss black, blue, red or machined finish with chrome center caps and rivets
- Center caps are included with each wheel, but lug nuts must be ordered separately
- Lug nut kit includes 16 lug nuts and 4 valve stems

FITS MODEL	POSITION	SIZE	BOLT PATTERN	OFFSET	MACHINED WHEEL PART #	BLUE WHEEL PART #	RED WHEEL PART #
BOMBARDIER/CAN-AM							
Outlander 330/400/500/570/650/800/850/1000 03-21	Front	12x7	4/136	4+3	0230-0440	-	0230-0865
	Rear	12x8	4/136	4+4	-	0230-0864	-
	Front	14x7	4/136	4+3	0230-0456	-	0230-0869
	Rear	14x8	4/136	4+4	0230-0461	0230-0868	-
Renegade 500/570/800/850/1000 09-21	Front	12x7	4/136	4+3	0230-0440	-	0230-0865
	Rear	12x8	4/136	4+4	-	0230-0864	-
	Front	14x7	4/136	4+3	0230-0456	-	0230-0869
	Rear	14x8	4/136	4+4	0230-0461	0230-0868	-
Traxter 4x4 99-06	Front	14x7	4/110	4+3	0230-0628	-	-
Quest 650 01-06	Front	14x7	4/110	4+3	0230-0628	-	-
Commander 800/1000 13-21	Front	12x7	4/136	4+3	0230-0440	-	0230-0865
	Rear	12x8	4/136	4+4	-	0230-0864	-
	Front	14x7	4/136	4+3	0230-0456	-	0230-0869
	Rear	14x8	4/136	4+4	0230-0461	0230-0868	-
Defender 16-21	Front	12x7	4/136	4+3	0230-0440	-	0230-0865
	Rear	12x8	4/136	4+4	-	0230-0864	-
	Front	14x7	4/136	4+3	0230-0456	-	0230-0869
	Rear	14x8	4/136	4+4	0230-0461	0230-0868	-
Maverick/Max 1000 14-21	Front	12x7	4/136	4+3	0230-0440	-	0230-0865
	Rear	12x8	4/136	4+4	-	0230-0864	-
	Front	14x7	4/136	4+3	0230-0456	-	0230-0869
	Rear	14x8	4/136	4+4	0230-0461	0230-0868	-
HONDA							
TRX300 Fourtrax 4x4 89-00	Front	14x7	4/110	4+3	0230-0628	-	-
TRX350 Rancher S-ES 4x4 00-06	Front	14x7	4/110	4+3	0230-0628	-	-
TRX400 Foreman 4x4 96-06	Front	14x7	4/110	4+3	0230-0628	-	-
TRX400/420 Rancher 4x4 04-21	Front	14x7	4/110	4+3	0230-0628	-	-
	Front	12x7	4/110	4+3	-	-	0230-0811
TRX420AT Rancher 09-21 (IRS)	Rear	12x8	4/110	4+4	0230-0625	0230-0804	0230-0812
	Front	14x7	4/110	4+3	0230-0628	0230-0807	0230-0815
	Rear	14x8	4/110	4+4	0230-0629	-	0230-0816

TYPE 387X continued on next page



TYPE 387X (CONT)

FITS MODEL	POSITION	SIZE	BOLT PATTERN	OFFSET	MACHINED WHEEL PART #	BLUE WHEEL PART #	RED WHEEL PART #
HONDA (CONT)							
TRX450/500 Foreman S-ES 4x4 98-16	Front	14x7	4/110	4+3	0230-0628	-	-
TRX500 Rubicon 4x4 01-11	Front	14x7	4/110	4+3	0230-0628	-	-
TRX650/680 Rincon 4x4 02-20	Front	12x7	4/110	4+3	-	-	0230-0811
	Rear	12x8	4/110	4+4	0230-0625	0230-0804	0230-0812
	Front	14x7	4/110	4+3	0230-0628	0230-0807	0230-0815
	Rear	14x8	4/110	4+4	0230-0629	-	0230-0816
Big Red 700 MUV 09-13	Front	12x7	4/110	4+3	-	-	0230-0811
	Rear	12x8	4/110	4+4	0230-0625	0230-0804	0230-0812
	Front	14x7	4/110	4+3	0230-0628	0230-0807	0230-0815
	Rear	14x8	4/110	4+4	0230-0629	-	0230-0816
Pioneer 500/700 14-21	Front	12x7	4/110	4+3	-	-	0230-0811
	Rear	12x8	4/110	4+4	0230-0625	0230-0804	0230-0812
	Front	14x7	4/110	4+3	0230-0628	0230-0807	0230-0815
	Rear	14x8	4/110	4+4	0230-0629	-	0230-0816
Pioneer 1000 16-21	Front	12x7	4/136	4+3	0230-0440	-	0230-0865
	Rear	12x8	4/136	4+4	-	0230-0864	-
	Front	14x7	4/136	4+3	0230-0456	-	0230-0869
	Rear	14x8	4/136	4+4	0230-0461	0230-0868	-
KAWASAKI							
Brute Force 650I 4x4 06-16 (IRS model)	Front	12x7	4/110	4+3	-	-	0230-0811
	Rear	12x8	4/110	4+4	0230-0625	0230-0804	0230-0812
	Front	14x7	4/110	4+3	0230-0628	0230-0807	0230-0815
	Rear	14x8	4/110	4+4	0230-0629	-	0230-0816
Brute Force 750 4x4 05-21	Front	12x7	4/110	4+3	-	-	0230-0811
	Rear	12x8	4/110	4+4	0230-0625	0230-0804	0230-0812
	Front	14x7	4/110	4+3	0230-0628	0230-0807	0230-0815
	Rear	14x8	4/110	4+4	0230-0629	-	0230-0816
Teryx 750/800 08-21	Front	12x7	4/136	4+3	0230-0440	-	0230-0865
	Rear	12x8	4/136	4+4	-	0230-0864	-
	Front	14x7	4/136	4+3	0230-0456	-	0230-0869
	Rear	14x8	4/136	4+4	0230-0461	0230-0868	-
Mule 2500/3000/4010 Series All	Front	12x7	4/136	4+3	0230-0440	-	0230-0865
	Rear	12x8	4/136	4+4	-	0230-0864	-
	Front	14x7	4/136	4+3	0230-0456	-	0230-0869
	Rear	14x8	4/136	4+4	0230-0461	0230-0868	-
*NOTE: Lift kit needed for 26" or larger tires	Front	12x7	4/156	4+3	0230-0439	0230-0805	0230-0813
	Rear	12x8	4/156	4+4	0230-0444	0230-0806	0230-0814
	Front	14x7	4/156	4+3	-	0230-0809	0230-0817
	Rear	14x8	4/156	4+4	0230-0460	0230-0810	0230-0818
KYMCO							
500MUX SA 08-10/MXU IE 08-11/500 UXV 10-14	Front	12x7	4/110	4+3	-	-	0230-0811
	Rear	12x8	4/110	4+4	0230-0625	0230-0804	0230-0812
POLARIS							
Sportsman 335 99-06	Front	12x7	4/156	4+3	0230-0439	0230-0805	0230-0813
	Rear	12x8	4/156	4+4	0230-0444	0230-0806	0230-0814
	Front	14x7	4/156	4+3	-	0230-0809	0230-0817
	Rear	14x8	4/156	4+4	0230-0460	0230-0810	0230-0818

TYPE 387X continued on next page



TYPE 387X (CONT)

FITS MODEL	POSITION	SIZE	BOLT PATTERN	OFFSET	MACHINED WHEEL PART #	BLUE WHEEL PART #	RED WHEEL PART #
POLARIS (CONT)							
Sportsman 400/450 01-16	Front	12x7	4/156	4+3	0230-0439	0230-0805	0230-0813
	Rear	12x8	4/156	4+4	0230-0444	0230-0806	0230-0814
	Front	14x7	4/156	4+3	-	0230-0809	0230-0817
	Rear	14x8	4/156	4+4	0230-0460	0230-0810	0230-0818
Sportsman 500 96-13	Front	12x7	4/156	4+3	0230-0439	0230-0805	0230-0813
	Rear	12x8	4/156	4+4	0230-0444	0230-0806	0230-0814
	Front	14x7	4/156	4+3	-	0230-0809	0230-0817
	Rear	14x8	4/156	4+4	0230-0460	0230-0810	0230-0818
Magnum 500 02-06	Front	12x7	4/156	4+3	0230-0439	0230-0805	0230-0813
	Rear	12x8	4/156	4+4	0230-0444	0230-0806	0230-0814
	Front	14x7	4/156	4+3	-	0230-0809	0230-0817
	Rear	14x8	4/156	4+4	0230-0460	0230-0810	0230-0818
Sportsman 570 14-18	Front	12x7	4/156	4+3	0230-0439	0230-0805	0230-0813
	Rear	12x8	4/156	4+4	0230-0444	0230-0806	0230-0814
	Front	14x7	4/156	4+3	-	0230-0809	0230-0817
	Rear	14x8	4/156	4+4	0230-0460	0230-0810	0230-0818
Sportsman 600 03-08	Front	12x7	4/156	4+3	0230-0439	0230-0805	0230-0813
	Rear	12x8	4/156	4+4	0230-0444	0230-0806	0230-0814
	Front	14x7	4/156	4+3	-	0230-0809	0230-0817
	Rear	14x8	4/156	4+4	0230-0460	0230-0810	0230-0818
Sportsman 700 02-09	Front	12x7	4/156	4+3	0230-0439	0230-0805	0230-0813
	Rear	12x8	4/156	4+4	0230-0444	0230-0806	0230-0814
	Front	14x7	4/156	4+3	-	0230-0809	0230-0817
	Rear	14x8	4/156	4+4	0230-0460	0230-0810	0230-0818
Sportsman 800 05-14	Front	12x7	4/156	4+3	0230-0439	0230-0805	0230-0813
	Rear	12x8	4/156	4+4	0230-0444	0230-0806	0230-0814
	Front	14x7	4/156	4+3	-	0230-0809	0230-0817
	Rear	14x8	4/156	4+4	0230-0460	0230-0810	0230-0818
Ranger ETX/570/EV/ 800 6x6 4x4 03-21	Front	12x7	4/156	4+3	0230-0439	0230-0805	0230-0813
	Rear	12x8	4/156	4+4	0230-0444	0230-0806	0230-0814
	Front	14x7	4/156	4+3	-	0230-0809	0230-0817
	Rear	14x8	4/156	4+4	0230-0460	0230-0810	0230-0818
Ranger XP900 & Diesel 14-18	Front	12x7	4/156	4+3	0230-0439	0230-0805	0230-0813
	Rear	12x8	4/156	4+4	0230-0444	0230-0806	0230-0814
	Front	14x7	4/156	4+3	-	0230-0809	0230-0817
	Rear	14x8	4/156	4+4	0230-0460	0230-0810	0230-0818
Sportsman Ace 570/900 14-16	Front	12x7	4/156	4+3	0230-0439	0230-0805	0230-0813
	Rear	12x8	4/156	4+4	0230-0444	0230-0806	0230-0814
	Front	14x7	4/156	4+3	-	0230-0809	0230-0817
	Rear	14x8	4/156	4+4	0230-0460	0230-0810	0230-0818
Sportsman XP 550/700/800/850 09-21	Front	12x7	4/156	4+3	0230-0439	0230-0805	0230-0813
	Rear	12x8	4/156	4+4	0230-0444	0230-0806	0230-0814
NOTE: Sportsman XP 2009 is 5" wider with aftermarket wheels	Front	14x7	4/156	4+3	-	0230-0809	0230-0817
	Rear	14x8	4/156	4+4	0230-0460	0230-0810	0230-0818
	Front	12x7	4/156	4+3	0230-0439	0230-0805	0230-0813
	Rear	12x8	4/156	4+4	0230-0444	0230-0806	0230-0814
Sportsman X2 500/550/800 09-15	Front	14x7	4/156	4+3	-	0230-0809	0230-0817
	Rear	14x8	4/156	4+4	0230-0460	0230-0810	0230-0818
	Front	12x7	4/156	4+3	0230-0439	0230-0805	0230-0813

TYPE 387X continued on next page



TYPE 387X (CONT)

FITS MODEL	POSITION	SIZE	BOLT PATTERN	OFFSET	MACHINED WHEEL PART #	BLUE WHEEL PART #	RED WHEEL PART #
POLARIS (CONT)							
RZR 800/900XP 08-14 & RZR 570 14-18	Front	12x7	4/156	4+3	0230-0439	0230-0805	0230-0813
	Rear	12x8	4/156	4+4	0230-0444	0230-0806	0230-0814
	Front	14x7	4/156	4+3	-	0230-0809	0230-0817
	Rear	14x8	4/156	4+4	0230-0460	0230-0810	0230-0818
RZR 900/900 XC/900 S 15-21	Front	12x7	4/156	4+3	0230-0439	0230-0805	0230-0813
	Rear	12x8	4/156	4+4	0230-0444	0230-0806	0230-0814
	Front	14x7	4/156	4+3	-	0230-0809	0230-0817
	Rear	14x8	4/156	4+4	0230-0460	0230-0810	0230-0818
RZR 1000 XP / 4 14-18	Front	12x7	4/156	4+3	0230-0439	0230-0805	0230-0813
	Rear	12x8	4/156	4+4	0230-0444	0230-0806	0230-0814
	Front	14x7	4/156	4+3	-	0230-0809	0230-0817
	Rear	14x8	4/156	4+4	0230-0460	0230-0810	0230-0818
SUZUKI							
King Quad 400 (Straight Axle) 4x4 08-18	Front	14x7	4/110	4+3	0230-0628	-	-
Eiger 400 4x4 02-07	Front	14x7	4/110	4+3	0230-0628	-	-
King Quad 450 05-21	Front	12x7	4/110	4+3	-	-	0230-0811
	Rear	12x8	4/110	4+4	0230-0625	0230-0804	0230-0812
	Front	14x7	4/110	4+3	0230-0628	0230-0807	0230-0815
	Rear	14x8	4/110	4+4	0230-0629	-	0230-0816
Vinson 500 4x4 02-08	Front	14x7	4/110	4+3	0230-0628	-	-
King Quad 700/750 05-21	Front	12x7	4/110	4+3	-	-	0230-0811
	Rear	12x8	4/110	4+4	0230-0625	0230-0804	0230-0812
	Front	14x7	4/110	4+3	0230-0628	0230-0807	0230-0815
	Rear	14x8	4/110	4+4	0230-0629	-	0230-0816
YAMAHA							
Grizzly 350 (Straight Axle) 4x4 08-12	Front	14x7	4/110	4+3	0230-0628	-	-
Big Bear 350/400 2x4/4x4 87-06	Front	14x7	4/110	4+3	0230-0628	-	-
Wolverine 350/450 4x4 95-08	Front	14x7	4/110	4+3	0230-0628	-	-
Bruin 350 2x4/4x4 04-06	Front	14x7	4/110	4+3	0230-0628	-	-
Grizzly 350 IRS 07-15	Front	12x7	4/110	4+3	-	-	0230-0811
	Rear	12x8	4/110	4+4	0230-0625	0230-0804	0230-0812
	Front	14x7	4/110	4+3	0230-0628	0230-0807	0230-0815
	Rear	14x8	4/110	4+4	0230-0629	-	0230-0816
Kodiak 400/450 4x4 93-04	Front	14x7	4/110	4+3	0230-0628	-	-
Kodiak 400/450 4x4 05-06	Front	12x7	4/110	4+3	-	-	0230-0811
	Rear	12x8	4/110	4+4	0230-0625	0230-0804	0230-0812
	Front	14x7	4/110	4+3	0230-0628	0230-0807	0230-0815
	Rear	14x8	4/110	4+4	0230-0629	-	0230-0816
Grizzly 400/450/550/700 4x4 07-21	Front	12x7	4/110	4+3	-	-	0230-0811
	Rear	12x8	4/110	4+4	0230-0625	0230-0804	0230-0812
	Front	14x7	4/110	4+3	0230-0628	0230-0807	0230-0815
	Rear	14x8	4/110	4+4	0230-0629	-	0230-0816
Big Bear 400 IRS 07-12	Front	12x7	4/110	4+3	-	-	0230-0811
	Rear	12x8	4/110	4+4	0230-0625	0230-0804	0230-0812
	Front	14x7	4/110	4+3	0230-0628	0230-0807	0230-0815
	Rear	14x8	4/110	4+4	0230-0629	-	0230-0816
Rhino 450/660/700 04-13	Front	12x7	4/110	4+3	-	-	0230-0811
	Rear	12x8	4/110	4+4	0230-0625	0230-0804	0230-0812
	Front	14x7	4/110	4+3	0230-0628	0230-0807	0230-0815
	Rear	14x8	4/110	4+4	0230-0629	-	0230-0816
Grizzly 600 98-01	Front	14x7	4/110	4+3	0230-0628	-	-

TYPE 387X continued on next page



TYPE 387X (CONT)

FITS MODEL	POSITION	SIZE	BOLT PATTERN	OFFSET	MACHINED WHEEL PART #	BLUE WHEEL PART #	RED WHEEL PART #
YAMAHA (CONT)							
Grizzly 660 02-09	Front	12x7	4/110	4+3	-	-	0230-0811
	Rear	12x8	4/110	4+4	0230-0625	0230-0804	0230-0812
	Front	14x7	4/110	4+3	0230-0628	0230-0807	0230-0815
	Rear	14x8	4/110	4+4	0230-0629	-	0230-0816
Viking 14-21	Front	12x7	4/110	4+3	-	-	0230-0811
	Rear	12x8	4/110	4+4	0230-0625	0230-0804	0230-0812
	Front	14x7	4/110	4+3	0230-0628	0230-0807	0230-0815
	Rear	14x8	4/110	4+4	0230-0629	-	0230-0816
Wolverine 16-18	Front	12x7	4/110	4+3	-	-	0230-0811
	Rear	12x8	4/110	4+4	0230-0625	0230-0804	0230-0812
	Front	14x7	4/110	4+3	0230-0628	0230-0807	0230-0815
	Rear	14x8	4/110	4+4	0230-0629	-	0230-0816
YZX 1000R 16-18	Front	14x7	4/110	4+3	-	0230-0809	0230-0817
	Rear	14x8	4/110	4+4	0230-0460	0230-0810	0230-0818

SIZE	BOLT PATTERN	OFFSET	MACHINED WITH BLACK WHEEL PART #	BLUE WHEEL PART #	RED WHEEL PART #
12x7	4/110	4+3	-	0230-0803	0230-0811
12x7	4/136	4+3	0230-0440	-	0230-0865
12x7	4/156	4+3	0230-0439	0230-0805	0230-0813
12x8	4/110	4+4	0230-0625	0230-0804	0230-0812
12x8	4/136	4+4	-	0230-0864	-
12x8	4/156	4+4	0230-0444	0230-0806	0230-0814
14x7	4/110	4+3	0230-0628	0230-0807	0230-0815
14x7	4/136	4+3	0230-0456	-	0230-0869
14x7	4/156	4+3	-	0230-0809	0230-0817
14x8	4/110	4+4	0230-0629	-	0230-0816
14x8	4/136	4+4	0230-0461	0230-0868	-
14x8	4/156	4+4	0230-0460	0230-0810	0230-0818

Kite

MX-EN ELITE WHEELS

- Complete wheels assembled from components chosen for top performance
- Takasago Excel signature rims, Alpina spokes and nipples, Koyo bearings and KITE hubs
- Machined aircraft aluminum hubs and matching spoke nipples are available in a wide variety of colors and color combinations
- 85cc small wheels (17"-14") are available with black spokes only



0203-0714



0203-0713

FRONT

FITS MODEL	SIZE	RIM COLOR	HUB COLOR	SPOKE/NIPPLES COLOR	PART #
SHERCO					
SE/SEF 125/250/300/450/500 13-23	1,60" x 21"	Black	Blue	Silver/blue	0203-0713
HUSQVARNA					
TC 65 17-23	1,60" x 14"	Black	Red	Silver/red	0204-0676
YAMAHA					
YZ 125/250 02-23, YZF 250/450 03-23	1,60" x 21"	Black	Blue	Silver/blue	0203-0715
YZF 250/450 14-23	1,60" x 21"	Blue	Blue	Silver/silver	0203-0716

MX-EN ELITE WHEELS continued on next page



MX-EN ELITE WHEELS (CONT)

REAR

FITS MODEL	SIZE	RIM COLOR	HUB COLOR	SPOKE/NIPPLES COLOR	PART #
GASGAS					
MC 65 21-23	1,60"x12"	Black	Red	Silver/red	0203-0714
KTM					
SX 65 08-23	1,60" x 14"	Black	Red	Silver/red	0204-0676
SHERCO					
SE/SEF 125/250/300/450/500 13-23	2,15" x 18"	Black	Blue	Silver/blue	0204-0674
SE/SEF 125/250/300/450/500 13-23	2,15" x 19"	Black	Blue	Silver/blue	0204-0675
YAMAHA					
YZ 125/250 02-23	2,15" x 19"	Blue	Blue	Silver/silver	0204-0678
YZ 125/250 02-23	2,15" x 19"	Blue	Titanium	Silver/silver	0204-0677
YZF 250/450 09-23	2,15" x 19"	Blue	Blue	Silver/silver	0204-0679



MX-EN FRONT SPORT WHEEL

- Complete wheel assembled from components chosen for top performance
- Excel ONE rim Alpina spokes and nipples, ISB bearings and KITE hub
- Machined aircraft aluminum hub and nipple spokes available in green
- Rim available in black

FITS MODEL	SIZE	COLOR	PART #
KAWASAKI			
KXF 250 21-23, KXF 450 19-23	1,60" x 21"	Red/green	0204-0673

SPOKE AND NIPPLE REPLACEMENT KITS

- KITE replacement spokes are made by Alpina, a world leader in the field
- High-resistance carbon steel construction allows far lighter spokes than the regular stainless steel spokes currently on the market
- Nipples are made of 7075 aircraft aluminum and forged to get maximum resistance and lightness
- For KITE complete wheels only
- Kit includes 16 spokes and 16 nipples

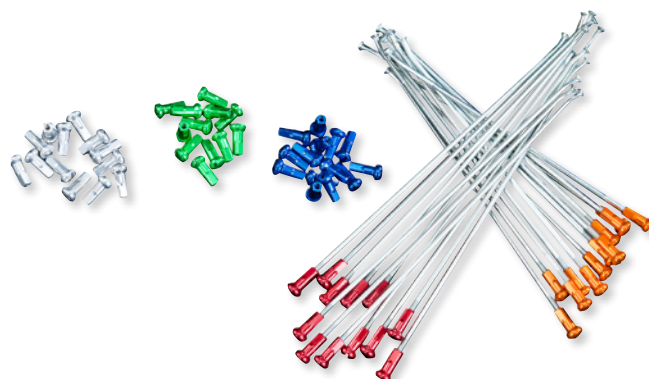

DESCRIPTION	COLOR	PART #	DESCRIPTION	COLOR	PART #
FRONT			REAR		
35,5 cm (14")	Silver/orange	0211-0237	40,65 cm (16")	Silver/orange	0211-0249
35,5 cm (14")	Silver/blue	0211-0238	40,65 cm (16")	Silver/blue	0211-0250
35,5 cm (14")	Silver/red	0211-0239	40,65 cm (16")	Black/orange	0211-0251
35,5 cm (14")	Black/orange	0211-0240	40,65 cm (16")	Black/blue	0211-0252
35,5 cm (14")	Black/blue	0211-0241	40,65 cm (16")	Black/Red	0211-0253
35,5 cm (14")	Black/red	0211-0242	35,5 cm (14")	Black/orange	0211-0254
43,2 cm (17")	Black/orange	0211-0243	35,5 cm (14")	Silver/blue	0211-0255
43,2 cm (17")	Black/blue	0211-0244	30,5 cm (12")	Silver/orange	0211-0256
43,2 cm (17")	Black/red	0211-0245	30,5 cm (12")	Silver/blue	0211-0257
48,25 cm (19")	Black/orange	0211-0246	30,5 cm (12")	Black/blue	0211-0258
48,25 cm (19")	Black/blue	0211-0247			
48,25 cm (19")	Black/red	0211-0248			



0222-0682

REPLACEMENT EXTERNAL SPACERS

FOR SHERCO SE/SEF 125/250/300/450/500 13-23

- Available in OE sizes
- Can be used with OE or KITE wheels

FITS MODEL	COLOR	PART #
FRONT		
SE/SEF 125/250/300/450/500 13-23 ¹	Blue	0222-0682
REAR		
SE/SEF 125/250/300/450/500 13-23	Blue	0222-0683

¹ Single piece



SPOKE WRENCH

- Double-sided wrench: 6.9mm for Kite MX-EN-MINICROSS 85cc wheels / 5.7mm for Kite MINICROSS 65cc wheels

- Forged wrench in Chrome Vanadium steel, chrome plated surface

DESCRIPTION	PART #
Chrome plated spoke wrench	3811-0131



1312-1072



1312-1070



1312-1066



1312-1058



SHOCK ABSORBERS

DOUBLE TUBE HYDRAULIC SHOCK

- OEM features
- Preload adjustment (step spring)
- ABE-approved, unless noted
- All are rear applications

EMULSION GAS SHOCK

- Preload adjustment (threaded spring)
- Compression adjustment; on some applications,
- the shock has an adjustable length
- The ECOLINE version offers only the preload adjustment
- ABE approved, unless noted
- All are rear applications

MOTO

FITS MODEL	TYPE	SHOCK TYPE	TUBE COLOR	SPRING COLOR	LENGTH (MM)	PRELOAD	PART #
BMW							
R 100 Classic Black Edition 77-95	MS	Top Line Emulsion Gas Shock	Black	Black	410	Threaded Spring/Rebound Adjustable	1312-1072
	MS	Top Line Emulsion Gas Shock	Black	Red	300	Threaded Spring/Rebound Adjustable/Length Adjustment +5/-5 mm	1312-1073
KTM							
Duke 125	TS	Ecoline Emulsion Gas	Black	Red	305	Threaded Spring/Rebound Adjustable/Length Adjustment +5/-5 mm	1312-1076

PIGGYBACK GAS SHOCK

- Bottom external reservoir
- Rebound and compression adjustment
- Preload adjustment (threaded spring)
- ABE Approved, unless noted
- All are rear applications, unless noted in chart

DOUBLE TUBE GAS (DTG) SHOCK

- Filled with both nitrogen gas and oil
- Preload adjustment (threaded spring)
- ABE Approved, unless noted
- All are rear applications, unless noted in chart

SHOCK ABSORBERS continued on next page



SHOCK ABSORBERS (CONT)

SCOOTER

FITS MODEL	TYPE	SHOCK TYPE	TUBE COLOR	SPRING COLOR	LENGTH (MM)	PRELOAD	PART #
APRILIA							
Sportcity 125 04-13	TS	Ecoline Emulsion Gas	Gold	Black	350	Threaded Spring	1312-1078
Sportcity 200 06-08	TS	Ecoline Emulsion Gas	Gold	Black	350	Threaded Spring	1312-1078
Sportcity 250 07-08	TS	Ecoline Emulsion Gas	Gold	Black	350	Threaded Spring	1312-1078
Sportcity 300 09-13	TS	Ecoline Emulsion Gas	Gold	Black	350	Threaded Spring	1312-1078
GILERA							
Cat 50 97-98	MS	Piggy Back Gas	Black	Matte black	285	Threaded Spring	1312-1065
	MS	Piggy Back Gas	Black	Matte black	310	Threaded Spring	1312-1066
Runner 50 97-00	MS	Piggy Back Gas	Black	Matte black	285	Threaded Spring	1312-1065
	MS	Piggy Back Gas	Black	Matte black	310	Threaded Spring	1312-1066
HONDA							
MTX 80 R 83-87	MS	Ecoline Emulsion Gas	Black	Red	300	Threaded Spring	1312-1074
Pantheon 125 (2T) 98-02	MS	Ecoline Emulsion Gas	Gold	Black	395	Threaded Spring	1312-1064
PCX 125 10-13	TS	Gas - DTG	Black	Black	315	Step Spring	1312-1063
PCX 125 18-20	TS	Gas - DTG	Black	Red	350	Step Spring	1312-1077
PCX 150 12-13	TS	Gas - DTG	Black	Black	315	Step Spring	1312-1063
PCX 150 18-	TS	Gas - DTG	Black	Red	350	Step Spring	1312-1077
Foresight 250 (FES 250) 98-05	MS	Ecoline Emulsion Gas	Gold	Black	395	Threaded Spring	1312-1064
Silver Wing 400 04-08	TS	Ecoline Emulsion Gas	Gold	Black	420	Threaded Spring	1312-1062
KYMCO							
Agility 125/150 06-15	TS	Gas - DTG	Black	Black	330	Step Spring	1312-1067
	TS	Gas - DTG	Black	Black	360	Step Spring	1312-1068
	TS	Gas - DTG	Black	Black	380	Step Spring	1312-1069
PIAGGIO							
Vespa Primavera 50 2T 13-17	MS	Gas - DTG	Black	Red	395	Step Spring	1312-1061
ROYAL ENFIELD							
	MS	Top Line Emulsion Gas Shock	Black	Red	405	Threaded Spring/Rebound Adjustable	1312-1071
SUZUKI							
Burgman 650 02-11	MS	Ecoline Emulsion Gas	Black	Black	370	Threaded Spring	1312-1075
SYM							
GTS 200 07-	TS	Gas - DTG	Black	Black	330	Step Spring	1312-1067
	TS	Gas - DTG	Black	Black	360	Step Spring	1312-1068
	TS	Gas - DTG	Black	Black	380	Step Spring	1312-1069
YAMAHA							
Finn 115i 18-	TS	Double Tube Hydraulic	Black	Chrome	280	Step Spring	1312-1057
	TS	Double Tube Hydraulic	Black	Black	300	Step Spring	1312-1058
	TS	Double Tube Hydraulic	Black	Black	320	Step Spring	1312-1059
Lagenda 115 13-	TS	Double Tube Hydraulic	Black	Chrome	280	Step Spring	1312-1057
	TS	Double Tube Hydraulic	Black	Black	300	Step Spring	1312-1058
	TS	Double Tube Hydraulic	Black	Black	320	Step Spring	1312-1059
NMAX 125 15-	TS	Gas - DTG	Black	Black	335	Step Spring	1312-1060
NMAX 155 15-19	TS	Gas - DTG	Black	Black	335	Step Spring	1312-1060



0405-1199



FRONT FORK SPRING KITS

- Shorter braking distance
- Better balance in the bike, more comfortable riding, even with passenger
- Easy cornering
- Improved tire life
- More grip in dry and wet weather
- More confidence; it makes your ride more comfortable and/or faster
- Overall sense of confidence in the bike
- Hyperpro progressive front fork spring kits include front fork oil

FITS MODEL	PART #	FITS MODEL	PART #	FITS MODEL	PART #
TRIUMPH		SUZUKI		YAMAHA	
Tiger 1050 Sport 17-20	0405-1199	DL650 V-Strom/XT 17-22 (max load)	0405-1206	MT-09 Tracer GT 18-20	0405-1201

REAR SHOCK SPRINGS

- Progressive rear spring is designed to smoothly transfer engine power to the road while controlling your bike, ensuring more stability and will significantly reduce tire wear
- Shorter braking distance
- Better balance in the bike, more comfortable riding, even with passenger
- Easy cornering
- More grip in dry and wet weather
- More confidence, it makes you feel more comfortable and/or faster
- Overall sense of confidence in the bike
- Available in black

FITS MODEL	PART #	FITS MODEL	PART #	FITS MODEL	PART #
TRIUMPH		SUZUKI		YAMAHA	
Tiger 1050 17-20	0405-1200	DL650 V-Strom/XT 17-22 (max load)	0405-1205	MT-09 Tracer 18-20	0405-1202



0405-1200



LOWERING SPRING KITS

- Lowering springs for original shocks
- Spring rate is designed to perform better than the original
- Available in either dual or rear placement position
- Made of lightweight aluminum
- CNC machined
- Easy mounting and perfect fitment
- Springs are black (unless noted in chart)
- ABE/GTÜ approved unless noted



0405-1203



FITS MODEL	LOWERING DISTANCE	POSITION	PART #
BMW			
R1250GS Ic Adventure ESA 18-22	25 mm	Dual	0405-1204
HONDA			
CB650R 19-20	25 mm	Rear	0405-1203



STEEL BACKING PLATE KIT WITH SCREWS

- Replacement backing plate and hardware for your Hinson Clutch Basket
- Change gear or service cushions on your Hinson Clutch Basket
- Brass finish

FITS MODEL	PART #
YAMAHA	
YFZ450 04-09	1132-1852
YFZ450R 11-22	1132-1852

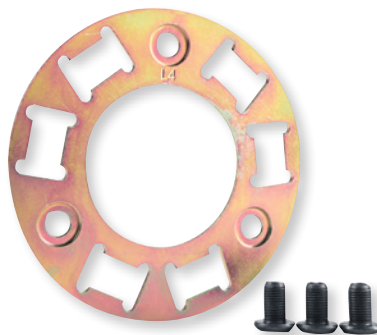

FITS MODEL	PART #
YAMAHA (CONT)	
YFZ450X 11	1132-1852
YFM700R Raptor 06-22	1132-1852



RAD VALVE REPLACEMENT AIR BOOT



1008-0357

- Replacement air boot for Rad valve PART #1008-0288

- Sold each

FITS MODEL	PART #
GAS GAS	
MC 65 21-23	1008-0357
HUSQVARNA	
TC 65 19-23	1008-0357
KTM	
SX 65 09-23	1008-0357



1011-4689



1011-4679



1011-4680

AIR FILTERS

- DT-1's world-class foam technology delivers maximum airflow while maintaining critical engine protection
- Their Super Seal base eliminates the need for grease and creates the cleanest and best seal on the market
- All DT-1 Air Filters are handmade with the highest quality bonded dual, triple and evolution foam available
- DT-1 Air Filters come non-oiled or pre-oiled with the highest quality flame-resistant biodegradable filter oil

SUPER SEAL STANDARD DUAL LAYER FOAM AIR FILTERS

- DT-1 standard air filters are constructed with high quality 15 mm dual-stage foam
- Custom-designed for each air box and filter cage for the best fitment and performance

SUPER SEAL TRIPLE LAYER FOAM AIR FILTERS

- The most contaminated place on the air filter is constructed with 20 mm triple foam, the rest of the filter with dual-stage foam
- Designed for extra protection and airflow
- Can be cleaned, re-oiled and reused like a dual-stage filter
- For use with DT-1 AirPower filter cages

AIRPOWER CAGES

- High-quality, lightweight aluminum cages don't flex like plastic cages, and eliminate the need for a backfire screen
- Use in combination with oiled DT-1 air filters for exceptional airflow, better throttle response and increased engine protection
- Triple/Evo fitments fit only with DT-1 Triple/Evo air filters

FITS MODEL	DUAL FOAM NOT-OILED	DUAL FOAM PRE-OILED	TRIPLE FOAM NOT-OILED	TRIPLE FOAM PRE-OILED	AIRPOWER CAGE
HONDA					
CRF250F 22-23	-	-	1011-4683	1011-4684	1011-4689
CRF250R/RX 22-23	-	-	1011-4683	1011-4684	1011-4689
CRF450R/RX/X 21-23, CRF450RL 22-23	-	-	1011-4683	1011-4684	1011-4689
HUSQVARNA					
TC125/250 23	1011-4679	1011-4680	1011-4685	1011-4686	-
FC250/450 Factory Edition 22	1011-4679	1011-4680	1011-4685	1011-4686	-
FC250/230/450 23	1011-4679	1011-4680	1011-4685	1011-4686	-
FE250/350/450/501 23	1011-4679	1011-4680	1011-4685	1011-4686	-
TE150i/250i/300i	1011-4679	1011-4680	1011-4685	1011-4686	-
FS450 23	1011-4679	1011-4680	1011-4685	1011-4686	-
KTM					
SX 125/250/300 23	1011-4681	1011-4682	1011-4687	1011-4688	-
SX-F 250/350/450 23	1011-4681	1011-4682	1011-4687	1011-4688	-
EXC150/250/300 TPI 23 (all)	1011-4681	1011-4682	1011-4687	1011-4688	-



CR/CRF BOLT KIT

- Comprehensive kit designed for CR/CRF 125-450 models from 2000 to current
- Many parts cross over for older models as well
- All parts are factory-style replacements
- 193 piece kit includes rotor bolts, shroud bolts, seat bolts, subframe bolts, fork guard bolts, factory hardware, aluminum bushings, aluminum rim-lock spacers, sprocket bolts, Fuji nuts, misc washers, valve stem parts, hex-head bolts and more

DESCRIPTION	PART #
CR/CRF bolt kit	2401-1568



KX/KXF BOLT KIT

- The KX/KXF 154 piece Bolt Kit includes factory style hex flange bolts with captured washers, hex head flange bolts, shroud bolts, seat bolts, sub-frame bolts, fork guard bolts, rotor bolts, sprocket bolts, factory hardware, rim lock spacers, valve stem parts, chain guide parts, Fuji lock nuts, misc washers and an axle nut!
- Fits Kawasaki KX/KXF model years 2003 to current
- Many parts will fit other Kawasaki dirt bikes

DESCRIPTION	PART #
KX/KXF bolt kit	2401-1570



M1 RM/RMZ BOLT KIT

- The RM/RMZ Bolt Kit is intended for RM/RMZ 125-450 models from 2000 to current
- Many parts cross over for older models, DR models and other Suzuki dirt bikes
- Includes 169 pieces of hardware including shroud bolts, seat bolts, sub-frame bolts, fork guard bolts, rotor bolts, sprocket bolts, T-nuts, aluminum bushings, rim lock spacers, valve stem parts, Fuji lock nuts, replacement bolts, and misc. washers

DESCRIPTION	PART #
RM/RMZ bolt kit	2401-1571



YZ/YZF/WR BOLT KIT

- The YZ/YZF/WR Bolt Kit is developed for 2003 to current YZ/YZF/WR 125-450
- Crosses over to older models as well
- This 172-piece kit includes several hardware pieces, sprocket bolts, rotor bolts, valve stem parts, Fuji lock nuts, replacement bolts, misc. washers and more

DESCRIPTION	PART #
YZ/YZF/WR bolt kit	2401-1569



M1 EURO BOLT KIT

- Kit developed for KTM 125-500
- Fits many Husqvarna, Husaberg, Beta and Gas Gas as well!
- Comprised of 160 pieces including factory-style KTM hardware, bolts, aluminum washers and concave washers, as well as dimpled flange bolts, carb screws, body screws, sprocket bolts, clips, valve stem parts and more

DESCRIPTION	PART #
Euro bolt kit	2401-1566



METRIC BOLT KIT

- The ultimate kit for riders with multiple brands of bikes
- Wide variety of parts in kit enables you to help out your buddies
- Kit includes approximately 179 parts including bolts, nuts, factory hardware and more
- Fits many full-size late-model Japanese motocross and off-road motorcycles

DESCRIPTION	PART #
Metric bolt kit	2401-1567



**REAR SPOILER FOR ICON AIRFORM/
AIRFORM MIPS HELMETS**

- Sold each
- RST colors may vary

DESCRIPTION

RST silver rear spoiler

PART #

0133-1205



A



B

Back view



MEN'S UPSTATE CANVAS CE™ JACKETS

- Clean and minimal styling
- Icon relaxed fit provides all-day riding comfort
- Durable 400D polyester and cotton stretch canvas chassis are ideal for the urban rider
- Abrasion-resistant overlays are paired with removable D30® elbow, shoulder and back impact protectors
- YKK® zippers, zipper vents at cuff and chest and 400D polyester reinforcements in elbows/shoulders
- Jacket tested and certified according to EN 17092-4:2020 class A
- D30® removable viper back protector; elbow and shoulder LP1 impact protectors - EN 1621-2:2014 / EN 1621-1:2012
- See Icon® Europe size conversion chart on page 264 of the 2022 Parts Europe Helmet & Apparel catalog before ordering

SIZE	(A) BLACK	(B) GRAY
S	2820-6235	2820-6241
M	2820-6236	2820-6242
L	2820-6237	2820-6243

SIZE	(A) BLACK	(B) GRAY
XL	2820-6238	2820-6244
2X	2820-6239	2820-6245
3X	2820-6240	2820-6246

SIZE	S	M	L	XL	2X	3X
Chest	89 cm - 94 cm (35"-37")	94 cm - 104 cm (37"-41")	104 cm - 112 cm (41"-44")	112 cm - 122 cm (44"-48")	122 cm - 135 cm (48"-53")	135 cm - 147 cm (53"-58")
Sleeve length	81 cm (32")	84 cm (33")	86 cm (34")	89 cm (35")	91 cm (36")	94 cm (37")