

RJWC
POWERSPORTS



1831-1052



1831-1053



1831-1051

DUAL SLIP-ON EXHAUSTS

- Built and assembled in northern Sweden
- All cans and tubes are SS304 stainless steel
- All aluminum parts are CNC-machined from 6061 billet
- Precision TIG-welded with high-quality filler rod; mandrel-bent tubing
- Great power increase
- Spark arrestor included

MUD EDITION EXHAUSTS

- One of the most exclusive exhausts released by RJWC
- One of the most refined top-tier exhausts for ATVs
- Incredible deep and clean sound

FITS MODEL	APX PART #	MUD PART #
CFMOTO		
Cforce 850/1000 (Split Dual)	1831-1052	-
Cforce 850/1000 XC 18-22	-	1831-1053
POLARIS		
Scrambler XP 1000S 20-22	-	1831-1053

APX EXHAUSTS

- All-aluminum modular exhaust
- CNC-machined brackets on all critical points
- CAD-drawn with extruded aluminum cans
- Cast stainless intake flanges and new inner cores

NOTE: All exhausts and mufflers are bolt-on and are made to fit stock vehicles; any aftermarket modifications or additions may affect exhaust fit.

FITS MODEL	APX PART #	MUD PART #
POLARIS (CONT)		
Sportsman XP 1000S 20-22	-	1831-1053
SEGWAY		
Villain	1831-1051	-

SINGLE SLIP-ON EXHAUSTS

- Built and assembled in northern Sweden
- All cans and tubes are SS304 stainless steel
- All-aluminum parts are CNC-machined from 6061 billet
- Precision TIG-welded with high-quality filler rod; mandrel-bent tubing
- Great power increase
- Spark arrestor included

APX EXHAUSTS

- All-aluminum modular exhaust
- CNC-machined brackets on all critical points
- CAD-drawn with extruded aluminum cans
- Cast stainless intake flanges and new inner cores

NOTE: All exhausts and mufflers are bolt-on and are made to fit stock vehicles; any aftermarket modifications or additions may affect exhaust fit.



APX PART #

FITS MODEL	APX PART #
CAN-AM	
Renegade G2 (Single centered)	1831-1054

EL'COMANDANTE EFI TUNER

- Prevents engine damage from running lean
- Works with any RJWC exhaust system
- Allows you to set correct air-to-fuel mixture according to manufacturer's recommended settings



1020-4039

FITS MODEL	PART #	FITS MODEL	PART #
CAN-AM		POLARIS	
Outlander/Renegade/Defender G2	1020-4039	Scrambler 850/1000	1020-4040
CFMOTO		SEGWAY	
Cforce 800/850	1020-4040	Sportsman 850/1000	1020-4040
Zforce 800	1020-4040	Snarler 570/600	1020-4043
Zforce 950/1000 Sport HO/HO EX	1020-4042	Villain	1020-4042
950/1000 Sport SSV (except HO/HO EX)	1020-4041		
Cforce/Uforce 1000	1020-4041		



1820-2019



1820-2020



1820-2022

Ti-6 AND T-6 4-STROKE EXHAUST SYSTEMS

- The Ti-6 Pro titanium exhaust system is created as a full race system, designed to increase performance and help professional racers pass AMA/FIM sound regulations
- The Ti-6 titanium exhaust system is designed to improve performance and power; constructed of titanium throughout the headpipe, mid pipe and canister; this is the ideal exhaust for any off-road or closed course racer looking for improved performance, durability and a professional look; comes with a removable spark arrestor making it easy to alternate between off-road and closed course riding
- The T-6 stainless steel exhaust system offers the same benefits as the Ti-6 titanium exhaust system, but the T-6 is constructed of stainless steel and aluminum for increased strength and durability while giving riders a more affordable alternative to titanium; comes with a removable spark arrestor making it easy to alternate between off-road and closed course riding

- Machined aluminum muffler brackets for increased strength and durability
- Asymmetrical muffler configuration for increased packing volume
- Most systems equipped with a RC-4 Resonance Chamber for reduced sound output
- Machined mid pipe to headpipe joint for a better, leak-free fit
- TIG precision welding



1820-2028

FITS MODEL	DESCRIPTION	PART #
HUSQVARNA		
FC250 23/Rockstar Edition 22	T-6 stainless steel system	1820-2019
	T-6 stainless system w/ titanium shell/carbon end cap	1820-2023
	Ti-6 titanium system	1820-2021
	Ti-6 Pro titanium system w/ carbon end cap	1820-2026
FC350 23	T-6 stainless steel system	1820-2019
	T-6 stainless system w/ titanium shell/carbon end cap	1820-2024
	Ti-6 titanium system	1820-2021
	Ti-6 Pro titanium system w/ carbon end cap	1820-2027
FC450 23/Rockstar Edition 22	T-6 stainless steel system	1820-2020
	T-6 stainless system w/ titanium shell/carbon end cap	1820-2025
	Ti-6 titanium system	1820-2022
	Ti-6 Pro titanium system w/ carbon end cap	1820-2028
KTM		
SX-F250 23/Factory Edition 22	T-6 stainless steel system	1820-2019
	T-6 stainless system w/ titanium shell/carbon end cap	1820-2023
	Ti-6 titanium system	1820-2021
	Ti-6 Pro titanium system w/ carbon end cap	1820-2026
SX-F350 23	T-6 stainless steel system	1820-2019
	T-6 stainless system w/ titanium shell/carbon end cap	1820-2024
	T-6 stainless system w/ titanium shell/carbon end cap	1820-2021
	Ti-6 Pro titanium system w/ carbon end cap	1820-2027
SX-F450 23/Factory Edition 22	T-6 stainless steel system	1820-2020
	T-6 stainless system w/ titanium shell/carbon end cap	1820-2025
	Ti-6 titanium system	1820-2022
	Ti-6 Pro titanium system w/ carbon end cap	1820-2028
YAMAHA		
YZF450 23	T-6 stainless steel/titanium system w/ carbon end cap	1820-2030
	Ti-6 titanium system w/ carbon end cap	1820-2031
	Ti-6 Pro titanium system w/ carbon end cap	1820-2032
	T-6 muffler	1821-2074
	T-6 stainless steel/aluminum system	1820-2029



1821-2068



1821-2069

T-6 SLIP-ONS

- T-6 Stainless Slip-On Silencers are designed for a rider looking for an inexpensive, easy-to-install, durable performance silencer that can bolt onto their stock headpipe
- Constructed of stainless steel throughout the mid-pipe and end cap while the canister is constructed of aluminum for increased durability
- Machined aluminum muffler bracket for increased strength and durability
- Asymmetrical muffler configuration for increased packing volume
- Removable spark arrestor
- TIG precision welding

FITS MODEL	DESCRIPTION	PART #
HUSQVARNA		
FC250 23/Rockstar Edition 22	T-6 stainless w/ removable spark arrestor	1821-2068
FC350 23	T-6 stainless w/ removable spark arrestor	1821-2068
FC450 22-23/Rockstar Edition 22	T-6 stainless w/ removable spark arrestor	1821-2069
KTM		
SX-F250 Factory Edition 22	T-6 stainless w/ removable spark arrestor	1821-2068
SX-F350 23	T-6 stainless w/ removable spark arrestor	1821-2068
SX-F450 Factory Edition 22	T-6 stainless w/ removable spark arrestor	1821-2069

Ti-2 SHORTY SILENCER FOR YAMAHA YZ125 22-23

- Pro Circuit's "premium" silencer with a 100% factory aesthetic
- Combines the use of noble materials to achieve absolute lightness and increase in the performance of your motorbike
- Made of Titanium/Kevlar with similar characteristics to R-304
- Mounting bracket made of CNC-machined aluminum
- For closed circuits only



DESCRIPTION	PART #
Ti-2 shorty silencer	1821-2072

304 FACTORY SOUND SILENCER FOR YAMAHA YZ125 22-23

- Features a longer midsection than the R-304 Shorty for stronger mid-to-high-rpm performance
- Excellent replacement for the OEM silencer while offering impressive performance gains
- 6061-T6 brushed aluminum housing
- Double-walled mounting brackets
- Stainless steel tubing and end cap
- Steel Allen-head screws for easy rebuilding/repacking
- Exclusive E-glass pillow packing



DESCRIPTION	PART #
304 factory sound silencer	1821-2070



R-304 SILENCER FOR YZ125 22-23

- The R-304 silencer was developed as a full-race two-stroke silencer
- The compact design of the short aluminum canister offers optimum performance gains and is recommended for closed-course racing only
- Hex head screws are used to secure the inlet cap and can be removed easily for quick repacking of the silencer
- 304 stainless steel intake tube
- Double-walled mounting bracket(s)
- 6061-T6 brushed aluminum silencer body
- Stainless steel end cap
- Allen head screws ensure easy repacking when needed for extended product life



DESCRIPTION	PART #
R-304 silencer	1821-2071

TYPE 296 SPARK ARRESTOR SILENCER FOR YAMAHA YZ125 22-23

- A quiet spark arrestor to use when riding in noise-sensitive areas
- Internal metal baffle, chambers and sound-absorbing materials for a muffled sound
- Constructed of aluminum and stainless steel
- Double-walled mounting bracket(s)
- Longer canister design keeps noise levels to a minimum
- No loss of motor performance



DESCRIPTION	PART #
296 S.A. silencer	1821-2073

WATER PUMP COVER FOR KAWASAKI KX250F 21-23

- Made from CNC-machined billet aluminum
- Strong, lightweight and durable to provide years of outstanding protection and performance
- Designed with an impeller to increase water flow and reduce hydraulic friction and cavitation



DESCRIPTION	PART #
Water pump cover	0940-2061



RETRO FENDER STICKER

- Retro-style Pro Circuit front fender sticker
- Thick, flexible vinyl with super sticky backing for a great look and easy application
- Set includes two side stickers
- Fits standard bikes (125cc-500cc)

DESCRIPTION	PART #
Retro front fender sticker	4320-2543



SERVICE CAP

- The Pro Circuit Service Cap is a snapback cap that goes great with almost anything
- One size fits all

DESCRIPTION	PART #
Black	2501-4101

PRO BLAZE SADDLEBAG SETS

- Lightweight and efficient aerodynamic design
- Constructed from durable UV-resistant 1680D ballistic nylon with water-resistant interior coating
- Side walls are made from dimensionally stable laminated EVA plastic
- Zippered volume expansion from 15 liters to 20 liters
- Include removable support arms that prevent contact with the rear tire
- A wide back strap attaches over the seat to connect the bags while providing additional support, stability and weight distribution
- Main pocket can be loaded from the top
- Reflective trim enhances visibility

FITS MODEL	DESCRIPTION	PART #
DUCATI		
Streetfighter V2 21-23	High saddlebag set	3501-1972
KAWASAKI		
Z900 SE 20-23	High saddlebag set	3501-1970
SUZUKI		
GSX-S 1000 GT 21-23	High saddlebag set	3501-1968



3501-1972

- Solid carrying handle
- High saddlebag set's backstrap is attached higher on the seat to prevent bags from high-placed exhaust
- Sold in pairs
- For the full line of Pro Blaze saddlebag sets, see page 123 of the 2022 Parts Europe Street catalog

FITS MODEL	DESCRIPTION	PART #
TRIUMPH		
Speed triple 1200 RR/RS 21-23	High saddlebag set	3501-1971
YAMAHA		
FZ1/FZ8 05-16	Saddlebag set	3501-1969



1510-1110

PRO SIDE CARRIERS

- Extremely durable, 2,5 mm-thick steel construction
- Fully removable with robust quick-release fasteners
- For permanent assembly, quick-release fasteners can be replaced by conventional M8 screws (sold separately)
- Black powdercoated finish
- For the full line of SW-Motech Pro side carriers, see page 111 of the 2022 Parts Europe Street catalog

FITS MODEL	PART #
DUCATI	
Desert X 22-23	1510-1110
HONDA	
X-Adv 20-23	1510-1109
MOTO MORINI	
X-Cape 650 21-23	1510-1111



1510-1104

SLC SIDE CARRIERS

- Allows for simple and secure mounting on the bike's original attachment points
- Quick-release mounting system allows side bags to be easily attached or removed
- Provides secure hold for side bags, side cases, adapter plates and universal side bracket number plates
- Available for both the left and right sides of the motorcycle
- Includes mounting hardware
- For the full line of SLC side carriers, see page 113 of the 2022 Parts Europe Street catalog

FITS MODEL	LEFT PART #	RIGHT PART #
TRIUMPH		
Tiger 660 21-23	1510-1103	1510-1104
ZERO		
SR/S 19-23	1510-1105	1510-1106
SR/F 19-23	1510-1107	1510-1108



ADVENTURE-RACK FOR MOTO MORINI X-CAPE 650 22-23

- Designed to withstand road vibrations, impact and high amounts of weight
- Made of light, but sturdy, 4 mm-thick aluminum alloy
- Mounts on original attachment points
- Multiple functional bores that are compatible with adapter kits for many top cases
- Expansive contact surface with plenty of tie-down points
- Black powdercoated finish
- For the full line of Adventure-Racks, see page 135 of the 2022 Parts Europe Street catalog

DESCRIPTION	PART #
Adventure-rack	1510-1102



0603-1103

REMOVABLE HANDLEBAR GPS MOUNTS

- Handlebar, cockpit and crossbar mounts available
- Gives the best possible view of both the dashboard and GPS
- Holder pivots and can be removed in an instant
- Universal drill-hole pattern fits many current GPS devices and SW-Motech smartphone hard cases
- Integrated shock absorption material protects device against vibrations
- Steel construction with black powdercoated finish

FITS MODEL	PART #
DUCATI	
Multistrada V4 20-23	0603-1103
KTM	
Super Adventure 1290 21-23	0603-1102



3502-0580

PRO TANK RINGS

- Allows mounting of PRO tank bags
- Convenient quick-lock mechanism allows the tank bag to be mounted or removed in seconds
- Bike-specific design provides complete stability and optimal fit
- Magnetic guide aid for easy attachment
- Simple installation
- Constructed from fiberglass-reinforced polyamide
- Mounting hardware included
- For the full line of PRO tank rings, see page 127 of the 2022 Parts Europe Street catalog

FITS MODEL	PART #
HONDA	
CMX Rebel 1100 20-23	3502-0580
SUZUKI	
GSX1300R Hayabusa 20-23	3502-0577
YAMAHA	
YZF-R7 21-23	3502-0578
Tenere 700 22-23	3502-0579



3502-0575

ION TANK RINGS

- Allows mounting of ION tank bags
- Convenient quick-lock mechanism allows the tank bag to be mounted or removed in seconds
- Bike-specific design provides complete stability and optimal fit
- Simple installation
- Constructed from fiberglass-reinforced polyamide
- Mounting hardware included
- For the full line of ION tank rings, see pages 130-131 of the 2022 Parts Europe Street catalog

FITS MODEL	PART #
KAWASKI	
Z650RS 21-23	3502-0575
TRIUMPH	
Tiger 660 21-23	3502-0573
YAMAHA	
YZF-R7 21-23	3502-0571
Tenere 700 22-23	3502-0576



WINDSCREEN FOR YAMAHA XSR900 21-23

- Made of extra-strong aluminum alloy to replace the original plastic front
- Includes base unit and windscreen
- Fits on original fairing mounts

DESCRIPTION	PART #
Windscreen	2312-0980



HEADLIGHT GUARD FOR YAMAHA TENERE 700 22-23

- Offers protection for factory headlights
- Sturdy steel construction
- Does not reduce light output
- Black powdercoated finish
- Simple installation with included mounting hardware

DESCRIPTION	PART #
Headlight guard	2001-2630

CRASH BARS

- Offer reliable protection for important components
- Model-specific design fits seamlessly with the lines of the bike and provide optimal cornering clearance
- No modifications needed for mounting
- Black powdercoated finish, unless noted
- Match the look and feel of the motorcycle
- 27 mm diameter
- Sold in pairs
- Include mounting hardware and instructions
- For the full line of Crash Bars, see pages 394-395 of the Parts Europe Street catalog



0505-2330

FITS MODEL	PART #	FITS MODEL	PART #	FITS MODEL	PART #
DUCATI		MOTO MORINI		YAMAHA	
Desert X 22-23	0505-2330	X-Cape 650 21-23	0505-2331	Tracer 9/GT 20-23	0505-2329

HEEL GUARDS FOR KAWASAKI Z650RS 21-23

- Protect the rider's boots from hot exhaust or swingarm movement
- Made of brushed aluminum
- Include mounting hardware
- Sold in pairs



DESCRIPTION	PART #
Heel guards	1731-0777



CENTERSTAND FOR KAWASAKI KLR 650 08-18

- Bike-specific design allows for easy mounting and a high-cornering clearance
- Easily lifts up motorcycle
- Highly corrosion-resistant
- Ideal for keeping the load off the tires during long periods of storage
- Black powdercoated surface
- Mounting hardware included
- For the full line of Centerstands, see page 384 of the 2022 Parts Europe Street catalog

DESCRIPTION

Centerstand

PART

0510-0637

BAR RISERS

- Change the seating position to enhance rider comfort
- Constructed from high-strength aluminum alloy
- Available in a variety of heights and do not require extending the original cables
- Sold in pairs
- For the full line of SW-Motech bar risers, see page 537 of the 2022 Parts Europe Street catalog

FITS MODEL	COLOR	RISER HEIGHT	PART #
TRIUMPH			
Tiger 660 21-23	Black	30 mm	0602-1429
RISER HEIGHT	COLOR	PART #	
FOR 22 MM (7/8") HANDLEBARS			
25 mm	Black	0602-1427	



RISER HEIGHT	COLOR	PART #
FOR 22 MM (7/8") HANDLEBARS (CONT)		
25 mm	Silver	0602-1428

BBSTORM HANDGUARDS

- Made of impact-resistant Moplen plastic
- Strong, full-wrapped aluminum frame
- Offer weather and crash protection
- Fit the original handlebars
- Sold in pairs
- For the full line of BBStorm handguards, see page 621 of the 2022 Parts Europe Street catalog

FITS MODEL	PART #	FITS MODEL	PART #
APRILIA		TRIUMPH	
Tuareg 660 21-23	0635-2289	Tiger 1200 Explorer (all)	0635-2289





EVO FOOTREST KITS

- Enhances stability, comfort and traction in any conditions
- 36 adjustment options
- Includes model-specific mounting hinge
- Rounded profile edges offer excellent grip
- Removable rubber insert increases surface area and provides extra support and comfort
- Passenger footrest kits also available
- Sold in pairs
- For the full line of EVO footrest kits, see page 752 of the 2022 Parts Europe Street catalog

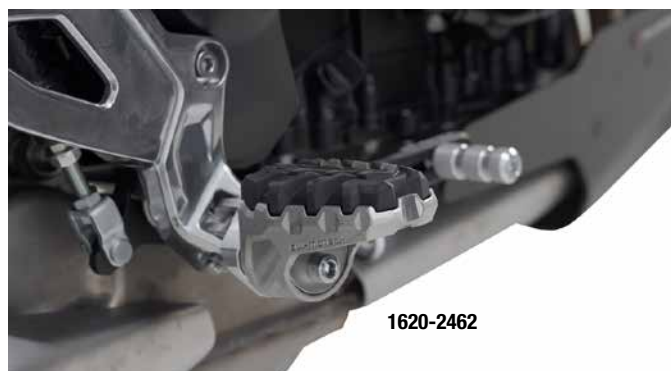

1620-2462

FITS MODEL	DESCRIPTION	PART #
TRIUMPH		
Tiger 660 21-23	Footrest kit	1620-2462
Tiger 1200 22-23	Footrest kit	1620-2463
	Passenger footrest kit	1620-2464

GEAR LEVER FOR TRIUMPH TIGER 660 21-23

- Modern, two-piece design and constructed with CNC-milled aluminum
- Spring mechanism enables lever to be folded down and protects it in case of a crash
- Can be adjusted 1 cm, 2 cm or 3 cm beyond the original position
- Scratch resistant
- For the full line of SW-Motech gear levers, see page 792 of the 2022 Parts Europe Street catalog



DESCRIPTION	PART #
Gear lever	1620-2465

BRAKE PEDAL EXTENSIONS

- Enhances the original brake pedal
- Raises contact surface by 22 mm or 27 mm
- Wider ridged contact surface improves grip even when wet and dirty
- For the full line of SW-Motech brake pedal extensions, see page 796 of the 2022 Parts Europe Street catalog



1610-0674

FITS MODEL	PART #	FITS MODEL	PART #
APRILIA		DUCATI	
Tuareg 660 21-23	1610-0674	Multistrada V4 20-23	1610-0675



4302-6976



4302-7001



4302-6977



0821-3524

GRAPHIC KITS, SEAT COVERS AND GRAPHIC KITS WITH SEAT COVERS FOR HONDA

- Graphic kits include radiator shrouds, front fender, rear fender, airbox, fork protectors and swingarm graphics (number plate backgrounds included only in Retro kits)
- Seat covers feature a customized seat area that provides better traction by using risers, extra grip and anti-slip positioning
- Graphic kits with seat covers include radiator shrouds, front fender, rear fender, airbox, swingarm, fork protectors, fork stickers, tank stickers (number plate backgrounds included only in Retro kits) and coordinating seat cover
- For the full line of Replica Team graphic kits for Honda, see page 451 of the 2022 Parts Europe Offroad catalog

FITS MODEL	GRAPHIC KITS	SEAT COVERS	GRAPHIC KITS WITH SEAT COVERS
RETRO			
CRF250R 22-23	4302-6976	-	-
CRF450R 21-23	4302-6976	-	-
STANDARD GRAPHIC KIT			
XR250/450 96-04	-	-	4302-7001
TEAM HRC 50TH ANNIVERSARY			
CRF250 22-23 (2021 edition)	4302-6977	0821-3524	-
CRF450 21-23 (2021 edition)	4302-6977	0821-3524	-



DREAM 4 GRAPHIC KITS AND GRAPHIC KITS WITH SEAT COVERS FOR HUSQVARNA

- Graphic kits include radiator shrouds, front fender and rear fender stickers
- Graphic kits with seat covers include radiator shrouds graphics, front fender stickers and rear fender stickers
- For the full line of Husqvarna Dream 4 graphic kits, see page 454 of the 2022 Parts Europe Offroad catalog

FITS MODEL

FC/TC 23

GRAPHIC KITS

4302-6988

GRAPHIC KITS WITH SEAT COVERS

4302-6999



SWINGARM STICKERS FOR HUSQVARNA FC/TC 23

- Sold in pairs
- For the full line of Blackbird's swingarm stickers for Husqvarna, see page 455 of the 2022 Parts Europe Offroad catalog

DESCRIPTION

Swingarm stickers

PART #

2320-0280



4302-6987



4302-6998



REPLICA TEAM GRAPHIC KITS AND GRAPHIC KITS WITH SEAT COVERS FOR HUSQVARNA

- Graphic kits include radiator shrouds, front fender, rear fender, airbox, fork protectors and swingarm graphics (number plate backgrounds included only in Retro kits)
- Graphic kits with seat covers include radiator shrouds, front fender, rear fender, airbox, swingarm, fork protectors, fork stickers, tank stickers (number plate backgrounds included only in Retro kits) and coordinating seat cover
- For the full line of Replica Team graphic kits for Husqvarna, see page 454 of the 2022 Parts Europe Offroad catalog

FITS MODEL

GRAPHIC KIT

GRAPHIC KIT WITH SEAT COVERS

FC/TC 23

4302-6987

4302-6998



4302-6983



4302-6995



REPLICA TEAM GRAPHIC KITS, SEAT COVERS AND GRAPHIC KITS WITH SEAT COVERS FOR KTM

- Graphic kits include radiator shrouds, front fender, rear fender, airbox, fork protectors and swingarm graphics (number plate backgrounds included only in Retro kits)
- Seat covers feature a customized seat area that provides better traction by using risers, extra grip and anti-slip positioning
- Graphic kits with seat covers include radiator shrouds, front fender, rear fender, airbox, swingarm, fork protectors, fork stickers, tank stickers (number plate backgrounds included only in Retro kits) and coordinating seat cover
- For the full line of Replica Team graphic kits for KTM, see page 458 of the 2022 Parts Europe Offroad catalog



4302-6997

FITS MODEL	GRAPHIC KITS	GRAPHIC KITS WITH SEAT COVERS
RETRO		
SX/SX-F 23 (purple/teal)	4302-6983	4302-6994
(red/white/blue)	4302-6984	4302-6995
MATTE BLACK		
SX/SX-F 19-22, EXC 20-23	-	4302-6986
SX/SX-F 23	-	4302-6997



4302-6996



DREAM 4 GRAPHIC KITS AND GRAPHIC KITS WITH SEAT COVERS FOR KTM

- Graphic kits include radiator shrouds, front fender and rear fender stickers
- Graphic kits with seat covers include radiator shrouds, graphics, front fender stickers and rear fender stickers
- For the full line of KTM Dream 4 graphic kits, see page 458 of the 2022 Parts Europe Offroad catalog

FITS MODEL	GRAPHIC KIT	GRAPHIC KIT WITH SEAT COVER
SX/SX-F 23	4302-6985	4302-6996

PRE-CUT NUMBER PLATE WITH GRAPHICS FOR KTM SX/SX-F 23

- Sold in sets
- For the full line of Blackbird Racing KTM pre-cut number plates, see page 459 of the 2022 Parts Europe Offroad catalog

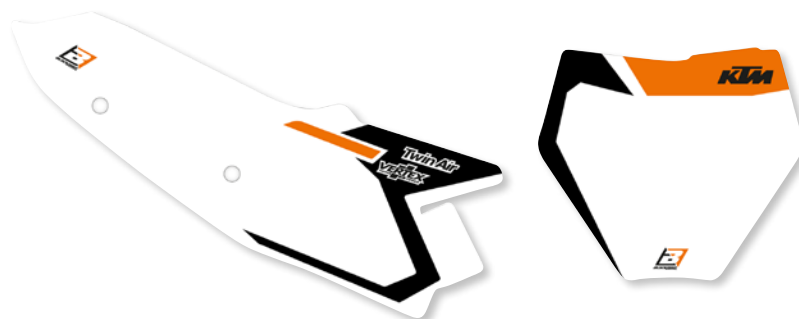

DESCRIPTION	PART #
Pre-cut number plate	4310-0975



RADIATOR LOUVER DECALS FOR KTM FOR KTM SX/SX-F 23

- Perfectly matches the KTM Dream 4 style
- For the full line of Blackbird Racing KTM radiator louver decals, see page 459 of the 2022 Parts Europe Offroad catalog

DESCRIPTION	PART #
Radiator louver decals	4302-6975



DREAM 4 FORK GUARD STICKERS FOR KTM SX/SX-F 23

- Sold in pairs
- For the full line of Blackbird Racing Dream 4 fork guard stickers for KTM, see page 459 of the 2022 Parts Europe Offroad catalog

DESCRIPTION	PART #
Dream 4 fork guard stickers	4302-7003



DREAM 4 GRAPHIC KITS FOR SUZUKI FOR SUZUKI DRZ400 00-22

- Graphic kit includes radiator shrouds, front fender and rear fender stickers
- For the full line of Suzuki Dream 4 graphic kits, see page 460 of the 2022 Parts Europe Offroad catalog

DESCRIPTION

Dream 4 graphic kit

PART

4302-6990



4302-7000

DREAM 4 GRAPHIC KITS AND GRAPHIC KITS WITH SEAT COVERS FOR BETA

- Graphic kits include radiator shrouds, front fender and rear fender stickers
- Graphic kits with seat covers include radiator shrouds graphics, front fender stickers and rear fender stickers
- For the full line of Blackbird Racing Beta Dream 4 graphic kits and graphic kits with seat covers, see page 464 of the 2022 Parts Europe Offroad catalog



FITS MODEL

RR 2T/4T 20-23

GRAPHIC KIT

4302-6989

GRAPHIC KIT WITH SEAT COVER

4302-7000



DREAM 4 GRAPHIC KITS AND GRAPHIC KITS WITH SEAT COVERS FOR YAMAHA

- Graphic kits include radiator shrouds, front fender and rear fender stickers
- Graphic kits with seat covers include radiator shrouds graphics, front fender stickers and rear fender stickers
- For the full line of Yamaha Dream 4 graphic kits, see page 462 of the 2022 Parts Europe Offroad catalog

FITS MODEL	GRAPHIC KIT	GRAPHIC KIT WITH SEAT COVER
YZ450F 23	4302-6979	4302-6992



0821-3534



4302-6978

4302-6993

REPLICA TEAM GRAPHIC KITS, SEAT COVERS AND GRAPHIC KITS WITH SEAT COVERS FOR YAMAHA

- Graphic kits include radiator shrouds, front fender, rear fender, airbox, fork protectors and swingarm graphics (number plate backgrounds included only in Retro kits)
- Seat covers feature a customized seat area that provides better traction by using risers, extra grip and anti-slip positioning
- Graphic kits with seat covers include radiator shrouds, front fender, rear fender, airbox, swingarm, fork protectors, fork stickers, tank stickers (number plate backgrounds included only in Retro kits) and coordinating seat cover
- For the full line of Replica Team graphic kits for Yamaha, see page 462 of the 2022 Parts Europe Offroad catalog



FITS MODEL	GRAPHIC KITS	SEAT COVERS	GRAPHIC KITS WITH SEAT COVERS
RALLY RIDE BLUE			
Tenere 700 20-23	4302-6982	0821-3534 ¹	-
-	-	0821-3536	-
RALLY RIDE RED			
Tenere 700 20-23	4302-6981	0821-3533 ¹	-
-	-	0821-3535	-

FITS MODEL	GRAPHIC KITS	SEAT COVERS	GRAPHIC KITS WITH SEAT COVERS
RETRO			
YZ450F 23	4302-6978	-	4302-6991
TEAM YAMAHA FACTORY RACING 2022			
YZ450F 23	4302-6980	0821-3531	4302-6993

¹ Two-piece seat cover.

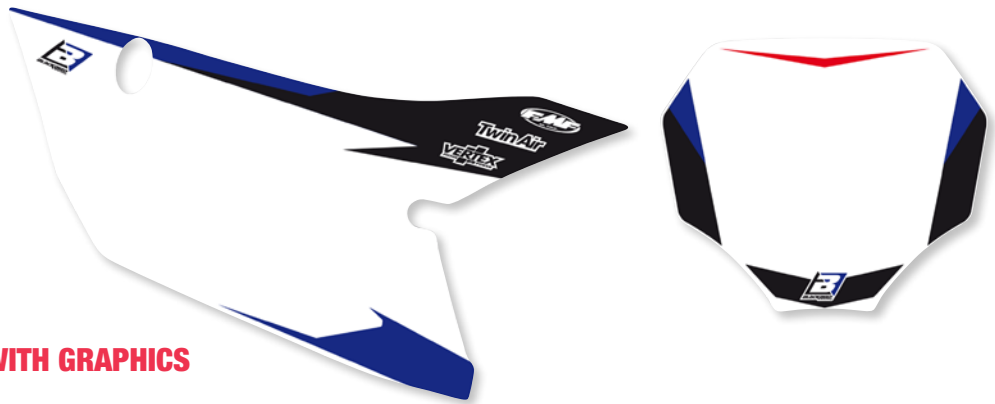

PRE-CUT NUMBER PLATES WITH GRAPHICS FOR YAMAHA YZ450F 23

- Sold in sets
- For the full line of Blackbird Racing pre-cut number plates, see page 463 of the 2022 Parts Europe Offroad catalog

DESCRIPTION

Pre-cut number plates

PART

4310-0974

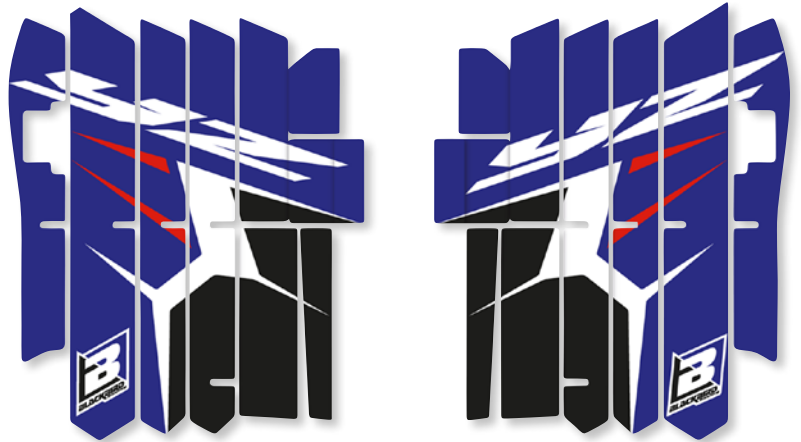

RADIATOR LOUVER DECALS FOR YAMAHA YZ450F 23

- Perfectly matches the Yamaha Dream 4 style
- For the full line of Blackbird Racing Yamaha radiator louver decals, see page 463 of the 2022 Parts Europe Offroad catalog

DESCRIPTION

Radiator louver decals

PART

4302-6974



DREAM 4 FORK GUARD STICKERS FOR YAMAHA YZ450F 23

- Sold in pairs
- For the full line of Blackbird Racing Dream 4 fork guard stickers for Yamaha, see page 463 of the 2022 Parts Europe Offroad catalog

DESCRIPTION

Dream 4 fork guard stickers

PART

4302-7002



0821-3542



0821-3537

TRADITIONAL SEAT COVERS

- Designed to directly replace the original seat cover
- Perfectly shaped to the seat
- Non-slip construction
- Moon design allows for foams of up to 2 cm

FITS MODEL	DESCRIPTION	PART #
HONDA		
XR 250/400 96-04	Traditional	0821-3543
Dominator (all)	Traditional	0821-3542
Transalp 88-99	Traditional	0821-3544

FITS MODEL	DESCRIPTION	PART #
KTM		
SX/SX-F 23	Moon	0821-3537
YAMAHA		
XT660 04-19	Traditional	0821-3545



0821-3551

0821-3553



0821-3527

PYRAMID SEAT COVERS

- New-generation anti-slip effect, made in material with excellent grip and a rubbery consistency that gives the rider perfect adherence to the seat in all conditions
- Excellent wear resistance
- Easy to apply, shaped parts specially studied to fit the shape of the seat
- For the full line of Pyramid seat covers, see pages 467-468 of the 2022 Parts Europe Offroad catalog

FITS MODEL	COLOR	PART #
BETA		
RR 2T/4T 20-23	Blue	0821-3541
	Black	0821-3552
GAS GAS		
EC 125/250/300 02-06	Black	0821-3551
FSE 450 02-06	Black	0821-3551
HUSQVARNA		
FC/TC 23	Black	0821-3556
KAWASAKI		
KX250F 21-23	Black	0821-3546

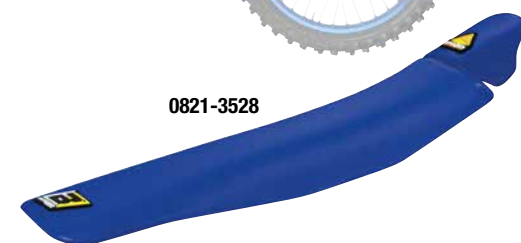

0821-3528

FITS MODEL	COLOR	PART #
KAWASAKI (CONT)		
KX450F 19-23	Black	0821-3546
KTM		
SX/SX-F 23	Black	0821-3538
	Orange	0821-3553
YAMAHA		
YZ125/250 22-23	Black	0821-3547
YZ450F 23	Black	0821-3527
	Blue	0821-3528



0821-3525



0821-3557



0821-3554



0821-3549

ZEBRA SEAT COVERS

- Excellent non-slip performance and durability
- Aggressive, up-to-date look
- For the full line of Blackbird Racing Zebra seat covers, see page 469 of the 2022 Parts Europe Offroad catalog

FITS MODEL	COLOR	PART #
HONDA		
CRF250 22-23	Black/red	0821-3525
CRF450 21-23	Black/red	0821-3525
HUSQVARNA		
TC 18-23	Black/yellow	0821-3555
FC/TC 23	Black/yellow	0821-3557

FITS MODEL	COLOR	PART #
KTM		
SX/SX-F 23	Orange/black	0821-3554
YAMAHA		
YZ125 22-23	Black/blue	0821-3526
YZ250 22-23	Black/blue	0821-3549
YZ250F 19-23	Black/blue	0821-3530
YZ450F 23	Black/blue	0821-3532



0821-3540



0821-3548

DOUBLE GRIP 3 SEAT COVERS

- Innovative strip system and ultra-resistant, excellent grip materials
- Raised strips specifically designed to allow riders to shift their weight directly onto the back wheel
- Excellent shock resistance
- For the full line of Double Grip 3 seat covers, see page 470 of the 2022 Parts Europe Offroad catalog

FITS MODEL	COLOR	PART #
HUSQVARNA		
FC/TC 23	Black/yellow	0821-3540
KTM		
SX/SX-F 23	Black/orange	0821-3539
TM		
MX-EN 2-stroke 15-21	Teal/white	0821-3550



0821-3550

FITS MODEL	COLOR	PART #
YAMAHA		
YZ125/250 22-23	Black/blue	0821-3548
YZ450F 23	Black/blue	0821-3529



0811-0270



0811-0268



0811-0272



0811-0266



SEAT FOAMS

- Made of waterproof polyurethane foam and perfectly interchangeable with the original
- Provides greater stiffness and speeds up the rider by shifting to balance the weight
- For the full line of Blackbird Racing seat foams, see pages 512-513 of the 2022 Parts Europe Offroad catalog

FITS MODEL	DESCRIPTION	PART #
HUSQVARNA		
FC/TC (all) 23	Standard	0811-0270
	15 mm	0811-0271
KTM		
SX/SX-F (all) 23	Standard	0811-0269
	15 mm	0811-0268

FITS MODEL	DESCRIPTION	PART #
YAMAHA		
YZ125/250 22-23	Standard	0811-0272
	15 mm	0811-0273
YZ450F 23	Standard	0811-0267
	15 mm	0811-0266

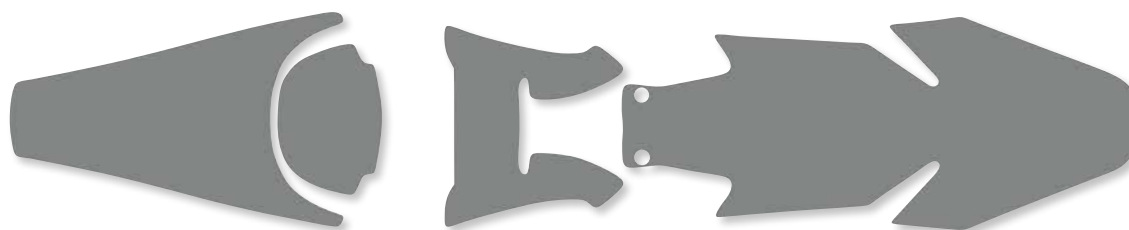

0521-2025

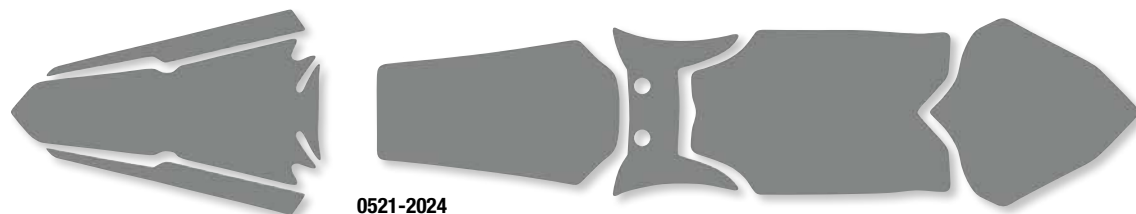

0521-2024

ANTI-MUD FOAM

- Keeps mud from building up on bike parts during wet and sticky trail/track conditions
- Shaped for specific applications

FITS MODEL	PART #	FITS MODEL	PART #	FITS MODEL	PART #
HUSQVARNA		KTM		YAMAHA	
FC/TC 23	0521-2025	SX/SX-F 23	0521-2024	YZ450F 23	0521-2023



4302-6909



4302-6959



4302-6862



4302-6943



4302-6936



4302-6883



SR1 SERIES SHROUD/AIRBOX GRAPHIC KITS

- Decals for right and left shroud, airbox and tank included if applicable
- Officially licensed product
- Made with thick ultracurve vinyl and Moto adhesives

FITS MODEL	PART #
HONDA	
CR85 03-08	4302-6914
CR125/250 93-94	4302-6916
CR125 95-97, CR250 95-96	4302-6917
CR125 98-99, CR250 97-99	4302-6918
CR125/250 00-01	4302-6919
CR125/250 02-08	4302-6920
CR500 91-01	4302-6932
CRF110F 13-18	4302-6909
CRF110F 19-22	4302-6910
CRF150F/230F 03-07	4302-6911
CRF150F/230F 08-14	4302-6912
CRF150F/230F 15-19	4302-6913
CRF150R 07-22	4302-6915
CRF250R 04-09	4302-6921
CRF250X 04-17	4302-6922
CRF250R 10-13, CRF450R 09-12	4302-6925
CRF250R 14-17, CRF450R 13-16	4302-6926
CRF250R 18-21, CRF450R 17-20	4302-6927
CRF250R 22-23, CRF450R 21-23	4302-6928
CRF250RX 19-21, CRF450RX 17-20, CRF450X/L 19-23	4302-6930
CRF250RX 20-23, CRF450RX 21-23	4302-6931
CRF450R 02-04	4302-6923
CRF450R 05-08	4302-6924
CRF450X 05-17	4302-6929
XR80/100 85-00	4302-6933
XR250/400 96-04	4302-6934
XR650R 00-10	4302-6935
HUSQVARNA	
TC 50 17-23	4302-6959
TC 65 17-23	4302-6960
WR450 12-15	4302-6905

FITS MODEL	PART #
HUSQVARNA (CONT)	
TC 85 14-17	4302-6961
TC 85 18-23	4302-6962
TC/FC 14-15, TE/FE 14-16 (includes TC250 16)	4302-6963
TC/FC 16-18, FE/TE 17-19 (except TC250 16), TX/FX 17-18	4302-6964
FC 250-450 Rockstar Edition 18.5, TC/FC/TX/FX 19-22, FE/TE 20-23	4302-6965
FC 250-450 Rockstar Edition 22.5, TC/FC/TX/FX 125-450 23	4302-6966
KAWASAKI	
KX65 00-19, KLX110 02-09	4302-6862
KX80/100 98-00	4302-6863
KX85/100 01-13	4302-6864
KX85/100 14-21	4302-6865
KX85/112 22-23	4302-6866
KX125/250 94-98	4302-6868
KX125/250 99-02	4302-6869
KX125/250 03-08	4302-6870
KX250 21-23	4302-6879
KX250F 06-08	4302-6871
KX250F 09-12	4302-6873
KX250F 13-16	4302-6875
KX250F 17-20	4302-6876
KX450 19-23	4302-6879
KX450F 06-08	4302-6872
KX450F 09-11	4302-6874
KX450F 12-15	4302-6877
KX450F 16-18	4302-6878
KX500 88-04	4302-6881
KLX110 10-22	4302-6867
KDX200/220 95-07	4302-6882
WR450 12-15	4302-6905

FITS MODEL	PART #
KAWASAKI (CONT)	
KLX450R 08-09	4302-6880
KTM	
SX50/Adventure 50 02-08	4302-6943
SX50 09-15	4302-6944
SX50 16-23, SX-E 20-23	4302-6945
SX65 02-08	4302-6946
SX65 09-15	4302-6947
SX65 16-23	4302-6948
SX85 13-17	4302-6949
SX85 18-23	4302-6950
SX125-525 01-04, MXC200/300 03-04, EXC125-525 03-04	4302-6951
SX125-525 05-06, EXC125-525 05-07	4302-6952
SX/SXF 125-450 07-10, EXC 08-11, SX 08-10	4302-6953
SX/SXF/XC/XCF 125-450 11-12, XCW/XCW-F 11-13, EXC 12-13	4302-6954
SX/SXF/XCF 125-450 13-15, XC 13-16, XC -W/XCW-F, EXC 14-16, SX250 16	4302-6955
SXF250-450 15.5, SX/SXF/XCF 16-18, XC 17-18, XC-W/XCW-F/EXC 17-19	4302-6956
SXF 250-450 18.5, SX/SXF 125-450 19-22, XC/XCF 19-22, XC-W/XCW-F/EXC 20-23	4302-6957
SXF250-450 Factory Edition 22.5, SX/SXF125-450 23, XC/XCF 23	4302-6958
SUZUKI	
RM85 02-23	4302-6936
RM 125/250 01-08	4302-6937
RMZ250 07-09	4302-6938
RMZ250 10-18	4302-6939
RMZ250 19-23, RMZ450 18-23	4302-6941
RMZ450 08-17	4302-6940
DRZ400 00-22	4302-6942
WR450 12-15	4302-6905

SR1 SERIES SHROUD/AIRBOX GRAPHIC KITS (continued on next page)



SR1 SERIES SHROUD/AIRBOX GRAPHIC KITS (CONT)

FITS MODEL	PART #
YAMAHA	
PW50 90-23	4302-6883
PW80 96-12	4302-6884
TTR110 08-22	4302-6908
TTR125 00-07	4302-6906
TTR125 08-22	4302-6907
YZ65 18-23	4302-6885
YZ85 02-14	4302-6886
YZ85 15-21	4302-6887
YZ85 23	4302-6888
YZ125/250 93-95	4302-6889
WR450 12-15	4302-6905

FITS MODEL	PART #
YAMAHA (CONT)	
YZ125/250 96-01	4302-6890
YZ125/250 02-14	4302-6891
YZ125/250 15-21	4302-6892
YZ125/250 23	4302-6893
YZ250F-426F 98-02	4302-6894
YZ250F/450F 03-05, WR250/450 05-06	4302-6895
YZ250F/450F 06-09	4302-6896
YZ250F 10-13	4302-6897
YZ250F 14-18, YZ450F 14-17, YZ250FX 15-19, WR250F 15-19	4302-6899
WR450 12-15	4302-6905

FITS MODEL	PART #
YAMAHA (CONT)	
YZ250F 19-23, YZ450F 18-22, YZ250FX 20-23, YZ450FX 19-22, WR250 20-23, WR450F 19-23	4302-6901
YZ450F 10-13	4302-6898
YZ450F 23	4302-6973
YZ450FX 16-18, WR450F 16-18	4302-6900
WR250-426 98-02	4302-6902
WR250-450 03-04	4302-6903
WR250 07-14, WR450 07-11	4302-6904
WR450 12-15	4302-6905

4302-6968



OEM SHROUD AND TANK/SHROUD GRAPHICS

- Look exactly like the original stock graphics, only better
- Scratch-proof printing on 16-mil thick Ultracurve® vinyl
- All graphics are pre-cut for easy installation
- Special gas tank adhesive is used where needed
- Graphics are durable enough to withstand the repeated use of a pressure washer

FITS MODEL	STYLE	PART #
HONDA		
CRF250 22-23	23	4302-6968
CRF450 22-23	23	4302-6968
KAWASAKI		
KX250F 21-23	23	4302-6969
KX450F 19-23	23	4302-6969



4302-6969



4302-6970



4302-6971

FITS MODEL	STYLE	PART #
SUZUKI		
RMZ250 19-23, RMZ450 18-23	23	4302-6970
YAMAHA		
YZ125/250 15-23	23	4302-6971
YZ250F 19-23, YZ450F 18-23	23	4302-6972



REPLICA TEAM HONDA 1987 SEAT COVER

- Features a customized seat area that provides better traction by using risers, extra grip and anti-slip positioning
- See page 494 of the 2022 Europe Offroad catalog for the entire line of Replica Team Honda seat covers



FITS MODEL	PART #
CR 125 87-88	0821-3522



REPLICA HONDA OEM 1995 SEAT COVER

- Seat cover features a customized seat area that provides better traction by using risers, extra grip and anti-slip
- See page 494 of the 2022 Europe Offroad catalog for the entire line of Replica Honda OEM seat covers



FITS MODEL	PART #	FITS MODEL	PART #
CR 125 93-97	0821-3523	CR 250 92-96	0821-3523



0635-2258



0635-2256



0635-2297



0635-2298



0635-2299

HANDGUARD HANDLEBAR CLAMP KITS

- Engineered for strength, versatility and easy installation
- Machined from high-grade aluminum
- Include hardware
- Clamps only – do not include aluminum backbone
- Sold in pairs

DESCRIPTION	PART #
For straight 22 mm (7/8") diameter handlebars	0635-2258
For straight 28,5 mm (1 1/4") diameter handlebars	0635-2257
For tapered handlebars	0635-2256

HANDLEBAR END PLUGS

- Designed to minimize grip damage
- Machined from high-grade aluminum with an anodized finish
- Include bar end fittings for 14 mm and 18 mm ID handlebars
- Sold in pairs

COLOR	PART #
Black	0635-2297
Blue	0635-2298
Gold	0635-2299



0635-2237



0635-2236



0635-2240

STORM HANDGUARDS

ADVENTURE/CRUISER/SCOOTER/STREET

- High impact-resistant plastic construction
- Large design for maximum wind and weather protection
- Multiple mount options available: can order plastic only for use with Barkbusters model-specific handguard mounts, or universal bar end or handlebar clamp complete kits
- Easy installation
- Dimensions: approximately 275 mm W x 140 mm H
- Optional accessory LED lights (PART #s 0635-2279 or 0635-2280) available separately
- Sold in pairs

BAR END MOUNT HANDLEBAR KITS (FOR HOLLOW OR THREADED END HANDLEBARS)

FITS HANDLEBAR STYLE	COLOR	PART #
For hollow end handlebars	Black	0635-2237
For 6 mm or 8 mm internal threaded handlebars	Black	0635-2236

STORM HANDGUARDS ONLY (FOR BARKBUSTERS HANDGUARD MOUNT KITS)

COLOR	PART #
Black	0635-2239
White	0635-2238

CLAMP MOUNT HANDGUARD KITS (SINGLE POINT CLAMP MOUNTS FOR ROUND HANDLEBARS)

FITS HANDLEBAR SIZE	COLOR	PART #
For 22 mm (7/8") diameter handlebars	Black	0635-2241
For 25,4 mm (1") diameter round handlebars	Black	0635-2240



0635-2214



0635-2215



0635-2216



0635-2217



0635-2218



0635-2219



0635-2220



0635-2221



0635-2222



0635-2223



0635-2224

VPS HANDGUARDS

MX/ENDURO

- High impact-resistant plastic construction
- Open-ended handguards and mounts, universal design allows for large range of adjustment in all directions
- Alloy handlebar clamp mounts with high-strength nylon brackets
- VPS (Variable Protection System) – guards have adjustable height wind deflectors that can be fitted in two different heights
- Deflectors can be removed quickly for a more compact look and feel

HANDGUARD COLOR	WIND DEFLECTOR COLOR	PART #
Yellow Hi-Viz	Black	0635-2214
Yellow	Black	0635-2215
White	Black	0635-2216
Silver	Black	0635-2217
Red	White	0635-2218
Pink	Black	0635-2219

- Easy installation
- Dimensions: approximately 250 mm W x 130 mm H (with wind deflector fitted) or 105 mm H (wind deflector not fitted)
- Optional accessory LED lights (PART #s 0635-2279 or 0635-2280) available separately
- Replacement wind deflectors (PART #s 0635-2272 or 0635-2273) available separately
- Sold in pairs

HANDGUARD COLOR	WIND DEFLECTOR COLOR	PART #
Orange	Black	0635-2220
Green	Black	0635-2221
Blue	White	0635-2222
Black	Black	0635-2223
Black on black	Black	0635-2224



0635-2225



0635-2226



0635-2227



0635-2228



0635-2229



0635-2230



0635-2231



0635-2232



0635-2233



0635-2234



0635-2235

VPS HANDGUARDS

ADVENTURE/ENDURO/STREET/SUPERMOTO

- High impact-resistant plastic construction
- Plastic only - no mounts included; fit Barkbusters motorcycle-specific handguard mount kits (available separately)
- VPS (Variable Protection System) – guards have adjustable height wind deflectors that can be fitted in two different heights
- Deflectors can be removed quickly for a more compact look and feel
- Guards have two mounting for a secure, full wraparound fit
- Easy installation

HANDGUARD COLOR	WIND DEFLECTOR COLOR	PART #
Yellow Hi-Viz	Black	0635-2225
Yellow	Black	0635-2226
White	Black	0635-2227
Silver	Black	0635-2228
Red	White	0635-2229
Pink	Black	0635-2230

- Dimensions: approximately 250 mm W x 130 mm H (with wind deflector fitted) or 105 mm H (wind deflector not fitted)
- Optional external bar end weights (PART #0636-2260) and accessory LED lights (PART #s 0635-2279 or 0635-2280) available separately
- Replacement wind deflectors (PART #s 0635-2272 or 0635-2273) available separately
- Sold in pairs

HANDGUARD COLOR	WIND DEFLECTOR COLOR	PART #
Orange	Black	0635-2231
Green	Black	0635-2232
Blue	White	0635-2233
Black	Black	0635-2234
Black on black	Black	0635-2235



SABRE HANDGUARDS

- Single-point mount, universal fit, open-ended handguards
- Clamps are manufactured from high-grade aluminum with adjustable fit in two side positions
- High impact-resistant molded plastic guards
- Low-profile guard provides minimalist design with venting for increased airflow

- Include top and bottom snap-in colored deflectors to provide maximum coverage from roost, trail debris and hard environments
- Can be used without deflectors for a low-profile, lightweight guard with vented openings
- Guard has up to 34 mm adjustment
- Complete set includes guards, top and bottom deflectors and mounting hardware

HANDGUARDS

HANDGUARD COLOR	DEFLECTOR COLOR	PART #
Hi Viz yellow	Black	0635-2179
Yellow	Black	0635-2180
White	White	0635-2181
Red	White	0635-2182
Orange	White	0635-2183

HANDGUARD COLOR	DEFLECTOR COLOR	PART #
Green	White	0635-2184
Blue	White	0635-2185
Black	Hi Viz yellow	0635-2186
Black	Yellow	0635-2187

SABRE HANDGUARDS (continued on next page)



SABRE HANDGUARDS (CONT)



0635-2188

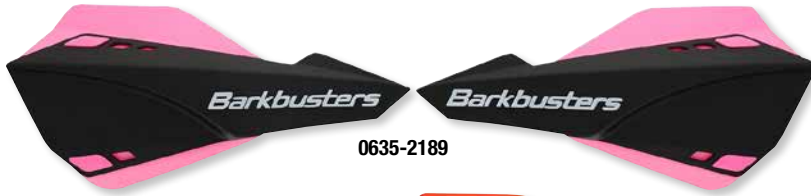

0635-2189



0635-2190



0635-2191



0635-2192



0635-2193

HANDGUARDS (CONT)

HANDGUARD COLOR	DEFLECTOR COLOR	PART #
Black	Red	0635-2188
Black	Pink	0635-2189
Black	Orange	0635-2190
Black	Green	0635-2191

HANDGUARD COLOR	DEFLECTOR COLOR	PART #
Black	Blue	0635-2192
Black	Black	0635-2193



0635-2261

HANDGUARD DEFLECTORS

COLOR	PART #
Hi Viz yellow	0635-2261
Yellow	0635-2262
White	0635-2263

COLOR	PART #
Red	0635-2264
Pink	0635-2265
Orange	0635-2266

COLOR	PART #
Green	0635-2267
Blue	0635-2268
Black	0635-2269

HANDGUARD DEFLECTOR PLASTIC ONLY

COLOR	PART #
Orange	0635-2293
Yellow	0635-2294

COLOR	PART #
Green	0635-2295
Red	0635-2296



0635-2281



0635-2282



0635-2283



0635-2284



0635-2287



0635-2285

MTB HANDGUARDS

- Single-point mount (open ended) hand/lever guards
- Adjustable fit with multiple side positions
- Low-profile minimalist design with vents for airflow on warm days
- Impact-resistant plastic guards provide protection for controls and cables
- Clamps are manufactured from lightweight high-strength aluminum and nylon and have an offset design so they can be positioned on either side of the controls
- Can use Sabre optional top and bottom deflectors (PART #s 0635-2261 thru -2269) for added coverage (sold separately)
- Sold in pairs

DESCRIPTION	COLOR	PART #
MTB handguards (pr.)	Black	0635-2281
	Blue	0635-2282
	Red	0635-2283
	Hi-Viz yellow	0635-2284
	White	0635-2287
Repl. MTB handguard clamp (ea.)		0636-2285



0635-2194



0635-2195



0635-2196



0635-2197



0635-2198



0635-2207

JET HANDGUARDS DUAL SPORT/ENDURO/TRAIL

- High impact-resistant plastic construction
- Profile is ideal for use on bikes with long clutch/brake levers
- Guards have two mounting points for a secure, full wraparound fit
- Easy installation
- Available as plastic guards only to fit Barkbuster motorcycle-specific handguard mount kits, or as complete two-point mount universal mount kits with guards for straight or tapered handlebars
- Dimensions: approximately 245 mm W x 110 mm H



0635-2212

- Optional external bar end weights (PART #0636-2260) and accessory LED lights (PART #s 0635-2279 or 0635-2280) available separately
- Sold in pairs

COLOR	PART #
PLASTIC ONLY (FOR USE WITH BARKBUSTERS HANDGUARD MOUNT KITS)	
Yellow	0635-2194
White	0635-2195
Red	0635-2196
Orange	0635-2197
Green	0635-2198
Blue	0635-2199
Black	0635-2200

COLOR	PART #
UNIVERSAL TWO-POINT MOUNT FOR USE W/ TAPERED HANDLEBARS	
Yellow	0635-2201
White	0635-2202
Red	0635-2203
Orange	0635-2204
Green	0635-2205
Blue	0635-2206
Black	0635-2207

COLOR	PART #
UNIVERSAL TWO-POINT MOUNT FOR USE W/ 22 MM (7/8") DIAMETER ROUND HANDLEBARS	
Yellow	0635-2208
White	0635-2209
Red	0635-2210
Green	0635-2211
Blue	0635-2212
Black	0635-2213



CARBON HANDGUARDS

STREET

- Genuine carbon fiber construction
- UV stable with a gloss-coated resin finish to prevent fading
- Sleek look for style and wind protection
- Can be fitted to Barkbusters motorcycle-specific mount kits and two-point and single-point universal mount kits
- Dimensions: approximately 255 mm W x 120 mm H
- Not recommended for off-road use
- Sold in pairs

DESCRIPTION	PART #
Carbon handguards	0635-2242

BBZ HANDGUARDS

ADVENTURE/CRUISER/SCOOTER/STREET

- Maximum hand protection in cold and extreme weather conditions
- Fabric handguard design is lined with a waterproof liner
- Can be fitted to almost any handlebar type
- Flexes around fairings and windscreens at full steering lock
- Ideal for faired sports and touring motorcycles
- Anti-flap design is self-supporting under wind pressure
- Do not interfere with operation of motorcycle controls
- Sleek look for style and wind protection
- Can be fitted independently or over existing Barkbusters mount kits – all necessary hardware included
- Dimensions: approximately 325 mm W x 170 mm H
- Sold in pairs

DESCRIPTION	PART #
BBZ handguards	0635-2243



EGO MINI HANDGUARDS

- Two-point universal mounts to fit minibike 22 mm (7/8") diameter handlebars
- Secure, full wraparound aluminum mount design with heat-treated backbone for strength
- Includes handguard plastic and mounts

COLOR	PART #
White	0635-2245
Red	0635-2246

COLOR	PART #
Orange	0635-2247
Black	0635-2248



AERO GP LEVER GUARDS STREET/TRACK

- Aerodynamic GP-styled lever guards
- Innovative design with high-tech construction
- Mount to a single point on the end of the handlebar
- Designed to guard against accidental contact of the brake or clutch lever while riding (NOT designed for impact protection)
- Include necessary hardware for fitting to 6 mm or 8 mm internal threaded handlebars as well as a unique locking system for mounting on hollow-end handlebars

- Adjustable reach (145 mm to 160 mm) for the extra lever clearance
- Aerofoils can be removed for a more compact, sporty style
- Extra aerofoil included
- Sold in left/right pairs

DESCRIPTION	PART #
Aero GP guards	0635-2244

TWO-POINT MOUNT HANDGUARD MOUNT KITS

- Custom designed, bike-specific hardware kits for the ideal fit
- Two mounting mounts for a secure, full wraparound design
- Heat-treated aluminum backbone for maximum strength and impact protection
- Compatible with Jet, VPS, Storm or Carbon handguards (sold separately)
- Must order mounts and a set handguards for a complete assembly



FITS MODEL	PART #
APRILIA	
Toureg 660 22-23	0635-2300
BMW	
G310GS 17-22	0635-2157
G310R 16-22	0635-2157
F650GS (up to -07)	0635-2178
F650GS 08-12	0635-2174
G650GS 08-10	0635-2178
G650GS 11-	0635-2170
G650GS Serato 11-	0635-2170
G650X Challenge (all)	0635-2177
G650X Country (all)	0635-2177
G650X Moto (all)	9635-2177
F700GS 13-15	0635-2171
F700GS 16-22	0635-2164
F750 GS 18-22	0635-2148
F800GS 08-12	0635-2174
F800GS 13-15	0635-2171
F800GSA 14-15	0635-2171
F800GS/GSA 16-22	0635-2164
F850 GS/GSA 18-22	0635-2148
R100 GS/GS PD (up to -90)	0635-2170
S1000XR 15-22	0635-2168
R1100GS (all)	0635-2175
R1150GS/GSA (all)	0635-2175
R nine T Scrambler/Urban GS 16-20	0635-2160
HP2 Megamoto 1200 07-09	0635-2174
R1200GS (up to -12)	0635-2174

FITS MODEL	PART #
BMW (CONT)	
R1200GSA (up to -13)	0635-2174
R1200GS/GSA 13-17	0635-2168
R1200R 15-18	0635-2168
R1250GS/GSA 18-22	0635-2148
R1250R 19-22	0635-2168
CF MOTO	
800 MT Sport/Touring 21-22	0635-2172
DUCATI	
Scrambler Sixty2 16-22	0635-2162
Scrambler 800 Classic/Urban Moto 15-22	0635-2162
Scrambler 800 Desert Sled/Flat Track Pro 17-22	0635-2159
Desert X 22-23	0635-2138
Multistrada 950/S/SW.Touring 19-22	0635-2137¹
Scrambler 1100/Special/Sport 18-22	0635-2159
Multistrada 1200/Euro 15-17	0635-2137¹
Multistrada 1260/S/Enduro 18-20	0635-2137¹
Multistrada V4/S/Sport 21-22	0635-2144
HONDA	
CB125E (all)	0635-2164
MSX125 Grom 14-20	0635-2146
CRF300L 21-22	0635-2142
CRF300L Rally 21-22	0635-2140
CB400X 20-22	0635-2151
CB500F 13-18	0635-2164⁶
CB500X 13-15	0635-2169⁶
CB500X 19-21	0635-2151³

FITS MODEL	PART #
HONDA (CONT)	
XL600V Transalp (all)	0635-2176⁶
XL650V Transalp (all)	0635-2176⁶
NC700X (all)	0635-2169⁶
XL700V Transalp (all)	0635-2176⁶
NC750X (all)	0635-2169⁶
CRF1000 Africa Twin 16-19 (all)	0635-2161
XL1000 Varadero (all)	0635-2169⁶
CRF1100 Africa Twin 20-22 (all)	0635-2150
VFR1200X (non DCT) up 10 -16	0635-2169
HUSQVARNA	
TR650 Terra 13-	0635-2167
KAWASAKI	
Z125 Pro 16-22	0635-2146
KLE250 Versys 17-22	0635-2172
KLE300 Versys X 17-22	0635-2172
KLE650 Versys (all)	0635-2173
KLR650 22-23	0635-2141
KLZ1000 Versys 19-22	0635-2154
KTM	
200 Duke 13-22	0635-2164
390 Adventure 20-22	0635-2149
390 Duke 13-16	0635-2164
1290 Super Duke R 14-22	0635-2165
MOTO GUZZI	
V85TT/TT Travel 19-22	0635-2145
ROYAL ENFIELD	
Himalayan 16-22	0635-2149²

¹ Designed to fit around the OEM Ducati handguard; no Barkbuster guard plastics available for this application.

² Not compatible with OEM braced handlebar. To avoid handguards making contact with the windscreen at full lock, the windscreen must be in the forward position.

³ Requires removal of the stock bar end weights. On 202 models with height adjustable windscreens, handguards may touch screen if it is in top position and handlebars are at full lock.

⁶ Requires removal of external and internal bar weights for installation.

TWO-POINT MOUNT HANDGUARD MOUNT KITS (continued on next page)



TWO-POINT MOUNT HANDGUARD MOUNT KITS (CONT)

FITS MODEL	PART #	FITS MODEL	PART #	FITS MODEL	PART #
SUZUKI		TRIUMPH (CONT)		YAMAHA	
DL250 V-Strom 17-22	0635-2147	Tiger 800 10-20 (all)	0635-2163	XT660R 04-	0635-2149
DL650 V-Strom (up to -16)	0635-2169	Tiger 900 GT/GT Low/GT Pro 20-22	0635-2286	XTZ660 Tenere 08-18	0635-2175
DL650XT V-Strom 16-22	0635-2169	Tiger 900 Rally/Rally Pro 20-22	0635-2286	MT-07 13-20	0635-2158 ⁵
SVF650 Gladius 09	0635-2164	Tiger 1050 Sport 13-	0635-2174	XTZ700 Tenere 19-22	0635-2153
DL1000 V-Strom 02-20	0635-2169	Scrambler 1200XC/XE 19-22	0635-2152 ⁴	XTZ1200 Super Tenere (up to -13)	0635-2171
DL1000XT V-Strom 18-19	0635-2156	Tiger 1200 Explorer (spoke wheels) 10-16	0635-2139	XTZ1200E Tenere 14-22	0635-2166
DL1050 V-Strom/XT 20-22	0635-2147	Tiger 1200 CX 10-16	0635-2139		
TRIUMPH		Tiger 1200 XC/XCA/XCX/ XR/XRT/XRX 17-21	0635-2155		

⁴ Storm handguards will not fit due to the shape of the handguard mount for this model.
⁵ This kit must be installed by a qualified service technician.

UNIVERSAL SINGLE POINT MOUNT HANDGUARD HARDWARE KITS

- Designed to fit with a single attachment to the handlebar
- Can mount either around the handlebar, at the inside of the controls or on the handlebar end
- Suitable for weather protection only
- Work with Storm or Carbon handguards (sold separately)

DESCRIPTION	PART #	DESCRIPTION	PART #
For straight 22 mm (7/8") dia. round handlebars	0635-2252	For 25,4 mm (1") diameter round handlebars	0635-2251

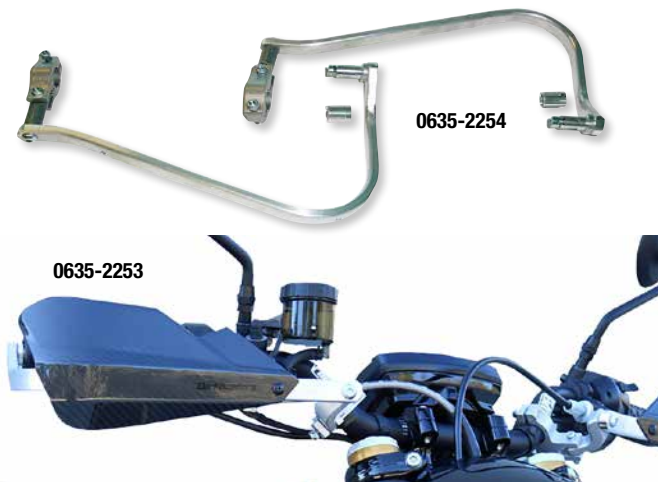

UNIVERSAL TWO-POINT MOUNT HANDGUARD HARDWARE KITS

- Universal design – will work with most handlebar types
- Two mount points for a secure, full wraparound mount design
- Heat-treated aluminum backbone for maximum strength and impact protection
- Work with Jet, Storm, VPS or Carbon handguards (sold separately)

DESCRIPTION	PART #
For straight 22 mm (7/8") dia. round handlebars	0635-2254
For tapered handlebars	0635-2253



UNIVERSAL BAR END MOUNT HANDGUARD HARDWARE KITS

- Mount to a single point on the handlebar end
- Incorporates an aluminum frame and locking cap to secure the handguard in place
- Available for hollow or internal threaded handlebars
- Work with Jet, VPS, Storm or Carbon handguards (sold separately)

NOTE: Use of hollow handlebar kit with 25,4 mm (1") diameter hollow handlebars requires adaptor kit PART #0635-2274 (sold separately).

DESCRIPTION	PART #
For hollow end handlebars	0635-2250
For 6 mm or 8 mm internal threaded handlebars	0635-2249
Opt. hardware adaptor kit for 25,4 mm (1") hollow handlebars	0635-2274

EXTERNAL BAR END WEIGHTS

- Fit with all Barkbusters aluminum backbones except EGO style
- Reduce handlebar vibration
- Weight approximately 180 g per side
- Black powdercoat finish
- Include all necessary mounting hardware
- Sold in pairs



DESCRIPTION	PART #
Bar end weights	0635-2260



0635-2270



0635-2271



0635-2272



0635-2273



0635-2275



0635-2276



0635-2277

ACCESSORIES/SPARE PARTS FOR HANDGUARDS AND KITS

- Accessories and replacement parts for Barkbusters handguards
- Available as listed

DESCRIPTION	PART #	DESCRIPTION	PART #
Hardware adapter kit for Yamaha (kit)	0635-2270	Hardware saddle kit for Storm handguards (kit)	0635-2276
Aluminum backbone brackets (pr.)	0635-2271	Hardware adapter kit for BMW 650GS (kit)	0635-2277
VPS wind deflectors (white) (pr.)	0635-2272	Clamp assembly for MX handguards (set of 2)	0635-2278
VPS wind deflectors (black) (pr.)	0635-2273	Clamp kit for VPS handguards (ea.)	0635-2255
Screw hardware kit for handguards (set of 4)	0635-2275		

HANDGUARD SKID PLATE

- Designed to fit with VPS plastic guards on a Barkbusters aluminum backbone mount
- Guards the outer edge of the aluminum backbone
- Add a stylish finish to the handguard
- Sold each



COLOR	PART #
Black	0635-2259



0635-2280



0635-2279

LED LIGHTS FOR BARKBUSTERS HANDGUARDS

AMBER LEDS

- Amber LEDs function as accessory turn signals
- E-mark approved as indicator lights
- May require optional resistor PART # 2130-0354 (sold separately) for correct flash rate
- Can be fitted to upper surface on JET guards, upper and lower surface on VPS and STORM guards
- Sold in left/right pairs

WHITE LEDS

- Increase visibility to other vehicles
- E-mark approved as position light
- Can be fitted to upper surface on JET guards, upper and lower surface on VPS and STORM guards
- Sold in left/right pairs



2130-0354

DESCRIPTION	PART #	DESCRIPTION	PART #	DESCRIPTION	PART #
Amber LEDs	0635-2280	White LEDs	0635-2279	Opt. LED resistors (pr.)	2130-0354



RACE CARBON HANDLEBARS

- 800 mm width, which can be cut down at rider's preference
- 35 mm clamp
- 5° of upsweep for comfort at any angle
- 9° of backsweep that is easier on wrists compared to most traditional bends
- Optimal flex, weight and strength is custom engineered
- Constructed from full carbon fiber

DESCRIPTION	PART #	DESCRIPTION	PART #
20 MM RISE		35 MM RISE	
Intergalactic	0601-5986	Intergalactic	0601-5987
Red	0601-5988	Red	0601-5989



0630-2931



0630-2932



0630-2933



0630-2934



0630-2938

PLUS 35 STEMS

- Created to reduce weight and use less material
- Strong and safe enough to race the Enduro World Series
- B3D-forged from AL-7050-T7 aluminum alloy for ultimate strength and absolute safety on the trail
- Zero-gap faceplates and T25 hardware with recessed steerer clamp bolts
- 35 mm bar clamp, 1 1/8" steerer clamp and 40 mm steerer clamp stack with a 0° rise

DESCRIPTION	PART #	DESCRIPTION	PART #
40 MM OFFSET		50 MM OFFSET	
Intergalactic	0630-2931	Intergalactic	0630-2935
Bronze	0630-2932	Bronze	0630-2936
Eggplant	0630-2933	Eggplant	0630-2937
Naranja	0630-2934	Naranja	0630-2938

Kite



1620-2445

1620-2446

SM FOOTPEGS

- Extra-wide footpegs give better control of the bike
- Easily replaceable stainless-steel blades, and high resistance polymeric slider
- Lightweight and excellent grip

FITS MODEL	COLOR	PART #
HUSQVARNA		
FC450 23, FS450 23	Orange	1620-2445
	Blue	1620-2446
KTM		
SXF450 23, XCF450 23, SMR450 23	Orange	1620-2445
	Blue	1620-2446
YAMAHA		
YZF450 23	Blue	1620-2444



1620-2441

1620-2442

1620-2443

MX-EN FOOTPEGS

- Extra-wide for better control of the bike
- Lightweight with maximum grip
- Easily replaceable stainless-steel blades

FITS MODEL	COLOR	PART #
HUSQVARNA		
TC125/250 23, FC250/350/450 23	Orange	1620-2441
	Blue	1620-2443
KTM		
SX125/250 23, SXF250/350/450 23, XC250/300 23, XC250/350/450 23	Orange	1620-2441
	Red	1620-2442
YAMAHA		
YZF450 23	Blue	1620-2440



MX-EN TRIPLE CLAMPS

- KITE triple clamps are precision-engineered using FEM (Finite Element Method) programming for optimal rigidity and reduced weight
- CNC-machined from 6082 aircraft aluminum for maximum durability
- Triple clamps have side window cut-outs for a racing look
- Prevent the fork from getting damaged in case of impact

FITS MODEL	OFFSET	COLOR	PART #
HUSQVARNA			
TC125/250 23, FC250/350/450 23	22 mm	Orange	0603-1097
	22 mm	Blue	0603-1098
KTM			
SX125/250 23, SXF250/350/450 23, XC300 23, XCF250/350/450 23	22 mm	Orange	0603-1097
		Blue	0603-1098



1231-1589



1231-1590



1231-1591

AXLE BLOCKS

- Allow for the changing of the sprocket without moving the chain setting

FITS MODEL	COLOR	PART #
KTM		
SX125/250 23, SXF250/350/450 23, XC250/300 23, XCF250/350/450 23	Orange	1231-1589
	Blue	1231-1590
	Black	1231-1591
HUSQVARNA		
TC125/250 23, FC250/350/450 23	Orange	1231-1589
	Blue	1231-1590
	Black	1231-1591

Kite



0204-0659

MX-EN ELITE WHEELS

- Complete wheel assembled with Takasago Excel signature rims, Alpina spokes and nipples, Koyo bearings and Kite hubs

FITS MODEL	SIZE	HUB COLOR	RIM COLOR	PART #
REAR				
HUSQVARNA				
FC250, TC125 23	1.85" X 19"	Orange	Silver	0204-0659
FC250/350/450 23, TC125/250 23	1.85" X 19"	Blue	Silver	0204-0660
	2.15" X 19"	Blue	Silver	0204-0664
	2.15" X 18"	Orange	Silver	0204-0665
	2.15" X 18"	Blue	Silver	0204-0665
	2.15" X 18"	Blue	Black	0204-0667

FITS MODEL	SIZE	HUB COLOR	RIM COLOR	PART #
REAR (CONT)				
KTM				
SXF250 23, XCF250 23, SX125 23	1.85" X 19"	Orange	Silver	0204-0659
SX125/250 23, SXF250/ 350/450 23, XC250/300 23, XCF250/350/450 23	2.15" X 19"	Orange	Silver	0204-0662
	2.15" X 19"	Blue	Silver	0204-0664
	2.15" X 18"	Orange	Silver	0204-0665
	2.15" X 18"	Blue	Silver	0204-0665
	2.15" X 18"	Blue	Black	0204-0667
SX/SXF (all except 65/85) 15-22	1.60" X 14"	Orange	Silver	0203-0579



0203-0710

A60 MX-EN ELITE WHEELS

- Complete wheel assembled with: Excel A60 rims, Alpina spokes and nipples, Koyo bearings and Kite hubs

FITS MODEL	SIZE	HUB COLOR	RIM COLOR	PART #
FRONT				
KTM				
SX/SXF (all except 65/85) 15-23	1.60" X 21"	Orange	Silver	0203-0710
REAR				
HUSQVARNA				
FC250 23, TC125 23	1.85" X 19"	Orange	Silver	0204-0661
FC250/350/450 23, TC125/250 23	2.15" X 19"	Orange	Silver	0204-0663
	2.15" X 18"	Orange	Silver	0204-0666

FITS MODEL	SIZE	HUB COLOR	RIM COLOR	PART #
REAR (CONT)				
KTM				
SX125 23, SXF250 23, XCF250 23	1.85" X 19"	Orange	Silver	0204-0661
SX125/250 23, SXF250/ 350/450 23, XC250/300 23, XCF250/350/450 23	2.15" X 19"	Orange	Silver	0204-0663
	2.15" X 18"	Orange	Silver	0204-0666



ADJUSTABLE HANDLEBAR RISERS

- Mount on either the original handlebar clamps or top yoke
- They allow for mounting of 28,6 mm oversized handlebars such as the Gilles GTO bars
- The 2D-GT Risers are fully adjustable and allow height adjustment in 5 mm increments and a reach adjustment of 50 mm
- Available in a range of hard anodised colors



FITS MODEL

TRIUMPH

Speed triple 1200 RS ABS 21-23

PART#

0602-1433

PASSENGER FOOTPEGS

- The replacement footrests (length 80 mm, non-slip surface) for the passenger position can be quickly and easily fitted to the original mounting points of the motorcycle thanks to the folding joints provided



1620-2469

FITS MODEL	SPORT PART#	TOURING PART#
TRIUMPH		
Speed triple 1050 R ABS	1620-2468	1620-2469
Speed triple 1050 S ABS	1620-2468	1620-2469
Speed triple 1200 RS ABS	1620-2468	1620-2469

GTA AXLE PROTECTOR

- Designed to limit the damage to the fork or swingarm arm areas during a lowside crash
- Crafted from high quality aluminum and durable POM plastic for maximum strength, low friction and excellent dimensional stability
- The GTA style axle protectors are available for front or rear and feature aluminum chamfer bolts for a quick and easy installation



FITS MODEL

FRONT PART#

REAR PART#

YAMAHA

MT-10 ABS 16-21	1231-1602	1231-1603
MT-10 SP ABS 17-21	1231-1602	1231-1603
YZF-R1 1000 ABS 15-22	1231-1602	1231-1603
YZF-R1M 1000 ABS 15-22	1231-1602	1231-1603
YZF-R6 600 17-20	1231-1602	1231-1603

MUE2 REARSETS

- Exact rearsset used on TST's 2015 R1 Race Bike
- High performance setup usable on street and track
- Adjustable, race-inspired foot location
- Reduces the chance of scraping during full lean
- Better body positioning in tuck and turning
- Stiff and durable, but lightweight
- Exclusive splined rotary adjustment mechanism
- Machined and anodized 7075 aluminum construction
- Direct bolt-on replacement
- Standard and GP/Reverse shifting possible
- Carbon fiber heel guards included



1623-0588



1623-0587

FITS MODEL

TRIUMPH

Speed Triple 1200 RS 21-22

PART

1623-0588

YAMAHA

MT10 22-23

1623-0587

MT10 SP ABS 22

1623-0587

SHIFTHOLDER KIT

FOR TRIUMPH SPEED TRIPLE 1200 RS ABS 21-23

- The original gear shaft stands too far out of the gearbox and bends elastically when shifting hard or quick which causes imprecise gear shifting
- This shiftholder helps eliminate gear shift problems and stabilizes the gear shaft to eliminate vague shifting
- Hard anodized titanium color



DESCRIPTION

Shiftholder kit

PART#

1602-1499



FRONT FORK SPRING KITS

- Shorter braking distance
- Better balance in the bike, more comfortable riding, even with passenger
- Easy cornering
- Improved tire life
- More grip in dry and wet weather
- More confidence; it makes your ride more comfortable and/or faster
- Overall sense of confidence in the bike
- Hyperpro progressive front fork spring kits include front fork oil
- ABE approved

FITS MODEL

HONDA

CRF300L 21

CRF300 Rally 21

CRF1100L Adventure Sport (no EERA) (DCT or non-DCT) 20-21

PART

0450-0660

0450-0659

0450-0658

STREETBOX

FOR HONDA NC750X 16-20

- Complete suspension kit in a box; includes everything listed below
- Hyperpro Emulsion shock absorber with preload and rebound adjustment and black shock spring
- Progressively wound front fork springs
- Correct weight and volume of front fork oil
- Setup manual with specifications for recommended suspension settings
- ABE approved



DESCRIPTION

Streetbox suspension kit

PART

1312-1047

REAR SHOCK SPRINGS

- Progressive rear spring is designed to smoothly transfer engine power to the road while controlling your bike, ensuring more stability and will significantly reduce tire wear
- Shorter braking distance
- Better balance in the bike, more comfortable riding, even with passenger
- Easy cornering
- More grip in dry and wet weather
- More confidence, it makes you feel more comfortable and/or faster
- Overall sense of confidence in the bike
- Available in black

FITS MODEL

HONDA

CRF300L 21-22

CRF300 Rally 21

CRF1100L Adventure Sport (no EERA) (DCT or non-DCT) 20-21

KAWASAKI

KLE500 91-07

PART

1312-1051

1312-1050

1312-1049

1312-1048



EMULSION SHOCK ABSORBER FOR TRIUMPH BONNEVILLE BOBBER 17-21

- Wet-born piston rod with self-adjusting bearing
- Radial piston with straight flow and pre-load through a pre-combustion oil chamber for optimum response
- Made from 7075-T6 aircraft aluminum
- Anti-Block System; separate pressure valve prevents a hydraulic lock of the shock
- Anti-Fading Damping System; steel tube and aluminum shock piston prevent fade when the temperature of the oil increases
- Rebound adjustment of 50 clicks
- Threaded spring preload adjuster
- Modular construction means every part can be replaced if needed to maintain peak suspension performance
- Black shock spring
- ABE approved

DESCRIPTION

Emulsion shock absorber

PART

1312-1046





SHOCK ABSORBERS
EMULSION GAS SHOCK

- Preload adjustment (threaded spring)
- Compression adjustment; on some applications, the shock has an adjustable length
- The ECOLINE version offers only preload adjustment
- ABE approved, unless noted
- All are rear applications

DIVIDED PISTON SHOCK

- Separate gas shock with split between gas and oil with bladder-free piston
- Displaces oil in the air
- Created for expert or sport riders for superb performance; can adjust for any riding style
- Better cooling over Emulsion Gas Shock
- Adjust the rebound and preload



FITS MODEL	TYPE	SHOCK TYPE	SPRING COLOR	LENGTH (MM)	PRELOAD	PART #
APRILIA						
RS 50 12-22	Ecoline Mono	Emulsion Gas	Red	290	Threaded Spring	1312-1052
YAMAHA						
YZF-R7 22	Top Line Mono	Divided Piston	Black	310	Threaded Spring	1312-1053
YCF						
Pitbike 125	Top Line Mono	Emulsion Gas	Gold	270	Threaded Spring	1312-1055
Pitbike 150	Top Line Mono	Emulsion Gas	Orange	280	Threaded Spring	1312-1054



HAND CLICKER ADJUSTER FORKS

- Only includes actuator, fork bolt sold separately
- Hand clicker compression adjuster for Showa fork
- Sold as a pair

DESCRIPTION	PART #
Red	0450-0657



OIL FILTER FOR VICTORY

- High-quality spin-on filter
- A dependable replacement for OEM #2540086
- Fits all Victory models from 95-17

DESCRIPTION	PART #
Black	0712-0481



OEM-STYLE REPLACEMENT AIR FILTER ELEMENTS

- High-quality paper filter medium
- Meets or exceeds OEM specifications
- For use with OEM stock air filter housings

FITS MODEL	REPLACES OEM #	PART #
Cross Country 11-17	7081648	1011-3520
Cross Country 8-Ball 15-16	7081648	1011-3520
Cross Roads Custom 11	7081648	1011-3520
Cross Roads 12	7081648	1011-3520



1011-3520



1011-3521

FITS MODEL	REPLACES OEM #	PART #
Cross Roads Classic/Hard Ball 13	7081648	1011-3520
Cross Roads Classic/8-Ball 14	7081648	1011-3520
Magnum 15-17	7081648	1011-3520
Vision 08-17	7081395	1011-3521



CLUTCH COVERS

- Precision machined from billet T-6 aircraft-quality aluminum
- Hard coated to resist boot wear
- Improves heat dissipation
- Stronger than stock
- Race-proven by factory race teams

FITS MODEL	PART #
GAS GAS	
MC125 24	0940-2113
HUSQVARNA	
TC125 23	0940-2113
TE150i 23	0940-2113
FC250 23-24	0940-2112
FC250 Rockstar Edition 22	0940-2112
FC450 23-24	0940-2112
FC450 Rockstar Edition 22	0940-2112

0940-2112



FITS MODEL	PART #
KTM	
SX125 23	0940-2113
EXC TPI 150/XC-W TPI 150 23	0940-2113
SX250/SX-F250 23-24	0940-2112
SX-F250 Factory Edition 22	0940-2112
XC250 23	0940-2112
SX-F350/SX-F450 23-24	0940-2112
SX-F450 Factory Edition 22-23	0940-2112



RPM MODE BUTTON

- Can be easily installed on the handlebar of your motorbike and allows you to set the optimal RPM level to be reached prior to starting
- Use the mode button to also customize the gear shift threshold

DESCRIPTION	PART #
RPM mode button	1020-4038



CDI CONTROL UNIT

- Provides optimal management of the ignition curve
- Ignition curves can be customized using Athena MAYA software
- Comes with two maps pre-installed: map 1 is RACE, map 2 is WET
- Handlebar-mount map toggle switch included
- Plug-and-play installation on standard engines

DESCRIPTION	PART#
CDI control unit	2101-0461



ENGINE CONTROL UNIT

- Wi-Fi Com ready; allows you to fine-tune engine parameters such as injection, ignition and rev limit using a smartphone or tablet (14-up GP1 and RX1 Power applications)
- Replacement ECU unit will maximize the performance of your machine without compromise
- ECU map provided will work with stock engine configuration and race exhaust
- More overall power with improved throttle and acceleration response

FITS MODEL	PART #	FITS MODEL	PART #	FITS MODEL	PART #
HONDA		KAWASAKI		KTM (CONT)	
CRF R 450 23	1020-4030	KX 250 21-22	1020-3520	SX-F 450 23	1020-4026
HUSQVARNA		KX 250 F 23	1020-4023	YAMAHA	
FC 250 23	1020-4025	KTM		YZ 125 22-23	1020-4032
FC 250 23	1020-4026	SX-F 250 23	1020-4025	YZ F 250 21-22	1020-3522
FC 350 23	1020-4031	SX-F 250 23	1020-4026	WR F 250 22	1020-3523
FC 450 23	1020-4026	SX-F 350 23	1020-4031	YZ F 450 23	1020-4024

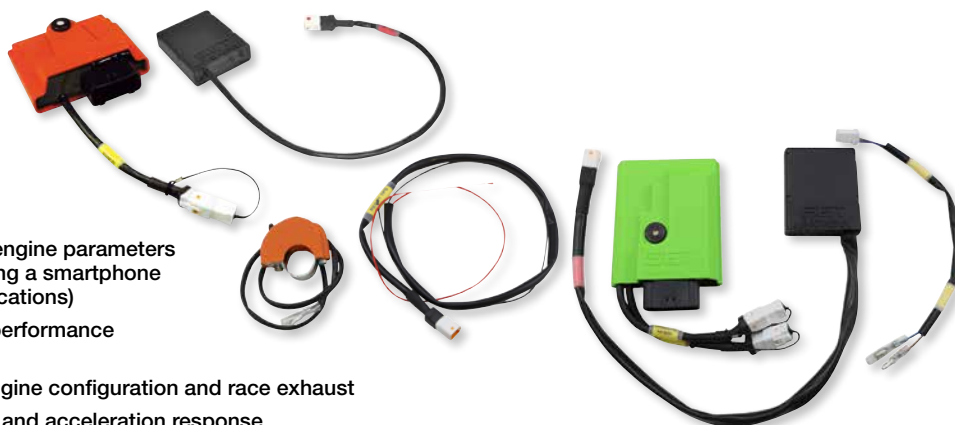

MOOSE
 RACING

TRUING STAND

- Professional truing stand for more precise results
- Includes 2 digital indicators to true side-to-side and up-down simultaneously – no more guesswork
- Flexible mounts fix indicators exactly where needed
- Lightweight, yet rigid, aluminum frame and axle fits wheels from 16"-21" with 20 mm-30 mm axles
- Unique threaded cones on axle keep wheel more secure than cones with index screws
- Stand's base has adjustable rubber feet to maintain level axle

DESCRIPTION

Truing stand

PART

0365-0138

WHEEL TRUING/BALANCING STAND

- Wide base and rigid steel construction
- Adjustable width accommodates wheels for dirt bikes and most street bikes
- Tall enough for dirt wheels with tire on
- Adjustable feet for level balancing/truing
- Includes level and adjustable truing pointer

DESCRIPTION

Wheel truing/balance stand

PART

0365-0112



FORK AND DUST SEAL KITS

- Seal profile is engineered to create equal pressure in each seal lip – equalized seal pressure creates less drag and longer seal life
- MAX-LIFE has a coefficient of friction up to 3 times less than the OEM seal material
- Triple-lip seal design
- Dyno-tested to last 3 to 4 times longer than OEM seals
- Directional ribs allow seal to be installed easily
- Kit includes fork seals and dust wipers



FITS MODEL	PART #	FITS MODEL	PART #	FITS MODEL	PART #	FITS MODEL	PART #
BETA		GAS GAS (CONT)		HONDA (CONT)		HONDA (CONT)	
RR 2T 125 19-22	0407-0103	EC250 4T 15	0407-0103	CRF230F 03-17	0407-0090	CRF450X 19-22	0407-0101
RR 2T 125 Race 21-22	0407-0358	EC250 4T 12-13	0407-0103	CRF230F 03-19	0407-0090	CRF450L 19-20	0407-0101
RR 2T 200 19-22	0407-0103	XC250 18-19	0407-0103	CRF230L 08-09	0407-0090	CR480R 82	0407-0178
RR 2T 200 Race 21-22	0407-0358	EC250 Six Days 19	0407-0103	CRF230M 09	0407-0090	CR480R 83	0407-0094
RR 2T 250 13-22	0407-0103	Enduro GP 250 18	0407-0103	CR250R 82	0407-0178	CR500R 84-88	0407-0319
RR 4T 250 05-07	0407-0104	EC250 4T 14	0407-0104	CR250R 83-88	0407-0319	CR500R 89-91	0407-0179
RR 2T 300 13-22	0407-0103	EC300 13-14	0407-0104	CR250R 89-91	0407-0179	CR500R 92-94	0407-0176
RR 2T 300 Race 22	0407-0103	EC300 4T 13	0407-0103	CR250R 92-94	0407-0176	CR500R 95	0407-0095
RX 2T 300 21-22	0407-0358	EC300 15-19	0407-0103	CR250R 95	0407-0095	CR500R 96-01	0407-0098
XTrainer 300 15-22	0407-0095	EC300 Six Days 19	0407-0103	CR250R 96	0407-0098	NX500 93-99	0407-0175
RR 4T 350 11	0407-0304	EC300 4T 14	0407-0104	CR250R 97-07	0407-0099	XL500R 82	0407-0090
RR 4T 350 13-22	0407-0103	EC300 4T 15	0407-0103	CRF250L 13-16	0407-0319	XR500 79-80	0407-0086
RR-S 4T 350 17-21	0407-0103	EC300 Replica 13-14	0407-0103	CRF250L 17-20	0407-0094		0407-0392 ¹
RR 4T 390 15-20	0407-0103	Enduro GP 300 18	0407-0103	CRF250L ABS 17-20	0407-0094	XR500R 81-82	0407-0090
RR-S 4T 390 17-21	0407-0103	EC300 Six Days 19	0407-0103	CRF250F 19-22	0407-0175	XR500R 83-84	0407-0094
RR 4T 390 Race 22	0407-0358	XC300 18-19	0407-0103	CRF250RL Rally 17-20	0407-0094	XL600R 83-87	0407-0316
RR 4T 400 05-10	0407-0104	EC450 4T 13	0407-0103	CRF250RL Rally ABS 17-20	0407-0094	XR600R 85-00	0407-0319
RR 4T 400 11	0407-0304	EC450 4T 14	0407-0104	CRF250R 04-09	0407-0099	FX650 99-00	0407-0175
RS 4T 400 14	0407-0103	EC450 4T 15	0407-0103	CRF250R 10-14	0407-0103	XR650L 93-22	0407-0319
RR 4T 430 15-20	0407-0103	Halley 450 EH 09	0407-0104	CRF250R 15-22	0407-0101	XR650R 00-07	0407-0097
RR-S 4T 430 17-21	0407-0103	Halley 450 SM 09	0407-0104	CRF250RX 19-22	0407-0101	HUSABERG	
RR 4T 430 Race 22	0407-0358	HONDA		CRF250X 04-17	0407-0099	FE250 13-14	0407-0102
RR-S 4T 430 17-21	0407-0103	CRM50R 93-96	0407-0086	NX250 88-90	0407-0090	TE250 11-14	0407-0102
RR-S 4T 430 Race 22	0407-0358	CRM75R 93-94	0407-0086	XL250R 82-87	0407-0086	TE300 11-14	0407-0102
RR 4T 450 05-10	0407-0104	CR80R 85-86	0407-0085		0407-0392 ¹	FE350 13-14	0407-0102
RR 4T 450 11	0407-0304		0407-0393 ¹	XR250 79-80	0407-0086	390FE 10-11	0407-0102
RS 4T 480 15-21	0407-0103	CR80R 87-95	0407-0086		0407-0392 ¹	450FC 01-05	0407-0102
RR 4T 480 Race 22	0407-0358		0407-0392 ¹	XR250 Tornado 01-02	0407-0175	450FE 04-11	0407-0102
RR-S 4T 500 17-20	0407-0103	CR80R 96-02	0407-0090	XR250L 91-96	0407-0175	450FE-E 01-03	0407-0102
RS 4T 500 15-16	0407-0103	CR80RB 96-02	0407-0090	XR250R 81-82	0407-0090	450FS 04	0407-0102
RR-S 500 17-21	0407-0103	CR85R/RB 03-07	0407-0090	XR250R 84-85	0407-0135	450FS-C 01-06	0407-0102
RR 4T 520 10	0407-0104	CR125R 82-83	0407-0135	XR250R 86-04	0407-0093	450FS-E 01-08	0407-0102
RR 4T 520 11	0407-0304	CR125R 84-86	0407-0178	XRE300 (SA) 10-12	0407-0175	450FX 10-11	0407-0102
RS 4T 520 14	0407-0103	CR125R 87-89	0407-0319	CRF300L 21-22	0407-0094	450FX-E 01-03	0407-0102
RR 4T 525 05-09	0407-0104	CR125R 90-91	0407-0179	CRF300L ABS 21-22	0407-0094	FE450 14	0407-0102
COBRA		CR125R 92-93	0407-0176	CRF300LR 21-22	0407-0094	FE501 13-14	0407-0102
CX 65 07-13	0407-0090	CR125R 94-96	0407-0095	CRF300LR ABS 21-22	0407-0094	550FE 07-08	0407-0102
GAS GAS		CR125R 97-07	0407-0098	CRF300LR ABS 21-22	0407-0094	550FS-E 07	0407-0102
MC 85 19/16 Wheel 21-22	0407-0091	XLR125 98	0407-0090	XL350R 84-85	0407-0316	570FE 09-11	0407-0102
EC125 13-15	0407-0104	CRF150R/RB 07-22	0407-0090	XR350R 83-85	0407-0175	570FS 10-11	0407-0102
EC200 14	0407-0104	CTX200 02-11	0407-0090	XR400R 96-04	0407-0319	650FC 04-05	0407-0102
EC200 15-19	0407-0103	TLR200 Reflex 86-87	0407-0085	CRF450R 02-08	0407-0099	650FE 04-08	0407-0102
XC200 18-19	0407-0103		0407-0393 ¹	CRF450R 09-12	0407-0103	650FS 04	0407-0102
EC250 13-14	0407-0104	XL200R 83-84	0407-0085	CRF450R 13-16	0407-0358	650FS 08	0407-0102
EX200 15-19	0407-0103		0407-0393 ¹	CRF450R 17-22	0407-0101	650FS-C 04-06	0407-0102
EX200 18-19	0407-0103	XR200 80-84	0407-0086	CRF450R 17-22	0407-0101	650FS-E 05-08	0407-0102
EC250 Replica 13-14	0407-0103		0407-0392 ¹	CRF450RL 21-22	0407-0101	HUSQVARNA	
EC250 15-19	0407-0103	XR200R 81-83	0407-0086	CRF450RX 17-20	0407-0101	TC 85 14-22	0407-0091
EC250 Six Days 19	0407-0103		0407-0392 ¹	CRF450RX 17-20	0407-0101	TC 85 BW 19-21	0407-0091
EC250 4T 10	0407-0104	XR200R 84-02	0407-0088	CRF450RX 17-20	0407-0101	CR125 96-08	0407-0104

¹ Fork dust seal kit only.

FORK AND DUST SEAL KITS continued on next page



FORK AND DUST SEAL KITS (CONT)

FITS MODEL	PART #	FITS MODEL	PART #	FITS MODEL	PART #	FITS MODEL	PART #
HUSQVARNA (CONT)		HUSQVARNA (CONT)		KAWASAKI (CONT)		KAWASAKI (CONT)	
CR125 09	0407-0304	FC 450 14-16	0407-0102	KX100 95-21	0407-0089	KX450X 21-22	0407-0101
CR125 10-13	0407-0103	FC450 17-22	0407-0103	KX112 22	0407-0089	KX 450 SR 22	0407-0101
TC 125 14-17	0407-0102	FC450 Rockstar Edition 18-22	0407-0103	KX125 78-79	0407-0088	KX500 83-87	0407-0178
TC 125 18-20	0407-0103	FE 450 14	0407-0102	KX125 80-81	0407-0135	KX500 88	0407-0096
TC 125 21-22	0407-0103	FE 450 16-20	0407-0103	KX125 83-87	0407-0178	KX500 89	0407-0097
TE 125 15-16	0407-0102	FS 450 18-20	0407-0103	KX125 88	0407-0096	KX500 90	0407-0174
WR125 96-08	0407-0104	FX 450 18-20	0407-0103	KX125 89	0407-0097	KX500 91-96	0407-0095
WR125 09	0407-0304	SM450 10	0407-0103	KX125 90	0407-0174	KX500 97-04	0407-0098
WR125 10-13	0407-0103	SM450R 03-05	0407-0104	KX125 91-95	0407-0095	KL600 84-86	0407-0135
TE150 17-19	0407-0103	SM450R 06-09	0407-0304	KX125 96-01	0407-0098	KL650 A (KLR) 87-07	0407-0135
TE150 I 20-21	0407-0103	TC450 03-05	0407-0104	KX125 02-05	0407-0103	KL650 B (KLR) 90-91	0407-0135
CR250 96	0407-0104	TC450 06-09	0407-0304	KDX175 80-82	0407-0088	KL650 E (KLR) 08-18	0407-0174
CR250 97-98	0407-0099	TC450 10-13	0407-0103	KDX200 83-85	0407-0135	KLX650 C 93-96	0407-0095
CR250 99-04	0407-0104	TE450 03-05	0407-0104	KDX200 86-92	0407-0178	KLX650D1 96	0407-0095
FC 250 14-16	0407-0102	TE450 06-09	0407-0304	KDX200 93-94	0407-0174	KLX650R 93-96	0407-0095
FC 250 17-22	0407-0103	TE450 10-13	0407-0103	KDX200 95-06	0407-0096	KTM	
FE 250 14-16	0407-0102	TXC450 08-09	0407-0304	KDX220 97-05	0407-0096	JR ADV 50 01	0407-0092
FE250 17-20	0407-0103	TXC450 10-13	0407-0103	KLX230R 20-22	0407-0090	JR ADV 50 02-03	0407-0143
TC250 03-07	0407-0104	FE 501 14-15	0407-0102	KLX230 20-22	0407-0090	Mini ADV 50 97-00	0407-0092
TC250 08-09	0407-0304	FE 501 16-21	0407-0103	KLX 230 ABS 22	0407-0090	Mini ADV 50 02-07	0407-0143
TC250 10-13	0407-0103	FE 501S 15-16	0407-0102	KLX 230s 22	0407-0090	SM 50 06	0407-0143
TC250 14-16	0407-0102	FE501S 20-21	0407-0103	KLXs ABS 22	0407-0090	SR ADV 50 02- 07	0407-0143
TC250 17-22	0407-0103	SM510 10	0407-0103	KDX250 80-84	0407-0135	50 SX 06-11	0407-0143
TE250 03-07	0407-0104	SM510R 05	0407-0104	KDX250 91-94	0407-0095	50 SX 12-16	0407-0357
TE250 08-09	0407-0304	SM510R 06-09	0407-0304	KL250 Super Sherpa 00-10	0407-0088	SX 50 Mini 08-11	0407-0143
TE250 10-13	0407-0103	TC510 05	0407-0104	KLR250 85-05	0407-0088	SX Pro JR 50 98-01	0407-0092
TE250 14-16	0407-0102	TC510 06-09	0407-0304	KLX250 79-80	0407-0088	SX Pro JR 50 02-09	0407-0143
TE250 17-18	0407-0103	TE510 04-05	0407-0104	KLX250R 94-96	0407-0095	SX Pro SR 50 98-99	0407-0092
TE250 I 18-21	0407-0103	TE510 06-09	0407-0304	KLX250S 06-20	0407-0095	SX Pro SR 50 02-05	0407-0143
TXC250 08-09	0407-0304	TE510 10	0407-0103	KLX250SF 09-10	0407-0095	SX SR 50 00	0407-0092
TXC250 10-13	0407-0103	TXC510 08-09	0407-0304	KX250 78	0407-0088	SXR Pro JR 50 97	0407-0092
WR250 98	0407-0304	TXC510 10	0407-0103	KX250 79-81	0407-0135	SXR Pro SR 50 97	0407-0092
WR250 99-08	0407-0104	TE/TXC 511 12-13	0407-0103	KX250 82-87	0407-0178	50 SXS 11-12	0407-0143
WR250 09	0407-0304	SM530R 09	0407-0304	KX250 88	0407-0096	50 SXS 13-14	0407-0357
WR250 10-13	0407-0103	SMR570 01-04	0407-0104	KX250 89	0407-0097	SX 60 98-00	0407-0092
TE 300 14-16	0407-0102	TC570 01-02	0407-0104	KX250 90	0407-0174	SX 65 98-01	0407-0092
TE300 17-18	0407-0103	TE570 01-04	0407-0104	KX250 91-95	0407-0095	SX 65 02-11	0407-0100
TE300 TPI 19-21	0407-0103	SM610 01-08	0407-0104	KX250 96-01	0407-0098	SX 65 12-16	0407-0357
TX300 17-19	0407-0103	SM-E610 99-01	0407-0104	KX250 02-07	0407-0103	SXS 65 13-14	0407-0357
TX300 I 20-22	0407-0103	SMR610 00-01	0407-0104	KX250F 04-05	0407-0103	XC 65 08-09	0407-0100
WR300 08-09	0407-0304	TC610 96-98	0407-0304	KX250F 06-12	0407-0099	SX 85 03-22	0407-0091
WR300 10-13	0407-0103	TC610 99-01	0407-0104	KX250F 13-20	0407-0103	SX 85 BW 13-22	0407-0091
TE310 09	0407-0304	TE610 98	0407-0304	KX250 20-22	0407-0103	SXS 85 13-14	0407-0091
TE310 10-13	0407-0103	TE610 99-08	0407-0104	KX250X 21-22	0407-0103	XC 85 08-09	0407-0091
TXC310 12-13	0407-0103	TE-E610 99-01	0407-0104	KLX300(R) 97-22	0407-0095	SX 105 06-11	0407-0091
FC 350 14-16	0407-0102	SMS630 10-11	0407-0104	KLX 300 22	0407-0095	XC 105 08-09	0407-0091
FC350 17-22	0407-0103	TE630 10-11	0407-0104	KLX 300 SM 21-22	0407-0095	EGS 125 96-99	0407-0104
FE 350 14-16	0407-0102	701 Enduro 16-20	0407-0103	KDX400 79-80	0407-0135	EXC 125 96-01	0407-0104
FE 350 17-20	0407-0103	701 Supermoto 16-20	0407-0103	KLX400R 03	0407-0101	EXC 125 02	0407-0091 ¹
FE 350S 15-16	0407-0102	KAWASAKI		KLX400SR 03-04	0407-0101	EXC 125 03-09	0407-0102
FE350S 20-21	0407-0103	KX65 00-22	0407-0085	KDX420 81	0407-0135	EXE 125 00- 01	0407-0091
FX 350 17-22	0407-0103		0407-0393 ¹	KX420 80-81	0407-0135	SX 125 96-98	0407-0104
WR360 96	0407-0104	KX80 90-91	0407-0086	KDX450 82	0407-0135	SX 125 99	0407-0305
WR360 97-98	0407-0304		0407-0392 ¹	KLX450R 08-09	0407-0103	SX 125 00-01	0407-0091
WR360 99-02	0407-0104	KX80 92-97	0407-0135	KLX 450 (AUS) 18-19	0407-0103	SX 125 02	0407-0091 ¹
SM400R 04	0407-0104	KX80 98-00	0407-0089	KX450F 06-12	0407-0103	SX 125 03-16	0407-0102
TE400 01	0407-0104	KX80 Big Wheel 92-94	0407-0089	KX450F 13-14	0407-0358	SX 125 17-22	0407-0103
TE410 96	0407-0104	KX85 01-22	0407-0089	KX450F 15-18	0407-0101	XC125 21-22	0407-0103
TE410 97-98	0407-0304	KX85 Big Wheel 01-18	0407-0089	KX450 19-22	0407-0101	SXS 125 04	0407-0102
TE410 99-01	0407-0104					SX 144 07-08	0407-0102

¹ Fork dust seal kit only.

FORK AND DUST SEAL KITS continued on next page



FORK AND DUST SEAL KITS (CONT)

FITS MODEL	PART #	FITS MODEL	PART #	FITS MODEL	PART #	FITS MODEL	PART #
KTM (CONT)		KTM (CONT)		KTM (CONT)		KTM (CONT)	
SX 150 09-16	0407-0102	EGS 300 95-96	0407-0104	MXC 400 01	0407-0091	SX 525 03-06	0407-0102
SX 150 17-22	0407-0103	EGS 300 97	0407-0304	MXC 400 02	0407-0091 ¹	XC 525 06-07	0407-0102
XC 150 10-14	0407-0102	EGS 300 98-99	0407-0305	RXC 400 96	0407-0104	XC-W 525 07	0407-0102
XC-W 150 17-19	0407-0103	EXC 300 95-96	0407-0104	SC 400 00	0407-0091	EXC 530 09-11	0407-0102
XC-W 150 TPI 20-22	0407-0103	EXC 300 97	0407-0304	SX 400 98-99	0407-0305	EXC-R 530 08-09	0407-0102
EGS 200 98-99	0407-0104	EXC 300 98-99	0407-0305	SX 400 00-01	0407-0091	XCR-W 530 08	0407-0102
EXC 200 98-99	0407-0104	EXC 300 00-01	0407-0091	SX 400 02	0407-0091 ¹	XC-W 530 09-11	0407-0102
EXC 200 00-01	0407-0091	EXC 300 02	0407-0091 ¹	SXC 400 00	0407-0091	SXS 540 01	0407-0091
EXC 200 02	0407-0091 ¹	EXC 300 03-05	0407-0102	TXC 400 98	0407-0305	SXS 540 02-06	0407-0102
EXC 200 03-05	0407-0102	MXC 300 95-96	0407-0104	XC-W 400 07-10	0407-0102	MXC 550 96	0407-0104
MXC 200 98-99	0407-0104	MXC 300 97	0407-0304	EXC 440 95	0407-0104	SMR 560 06-07	0407-0102
MXC 200 00-01	0407-0091	MXC 300 98-99	0407-0305	EXC 450 03-04	0407-0102	SMR 560 07	0407-0102
MXC 200 02	0407-0091 ¹	MXC 300 00-01	0407-0091	EXC 450 07-11	0407-0102	620 TXC 98	0407-0305
MXC 200 03	0407-0102	MXC 300 02	0407-0091 ¹	EXC 450 14	0407-0102	Comp Limited 620 97	0407-0305
SX 200 00-02	0407-0091	MXC 300 03-05	0407-0102	EXC 450 03-14	0407-0102	Comp. 620 97-99	0407-0305
SX 200 03-04	0407-0102	XC 300 06-16	0407-0102	EXC-F 450 Six Days 17-19	0407-0103	LC4 620 97-98	0407-0305
XC 200 06-09	0407-0102	XC 300 17-19	0407-0103	EXC-F 450 20	0407-0103	LC4 Comp 620 99	0407-0305
XC-W 200 06-15	0407-0102	XC 300 TPI 20-22	0407-0103	EXC-G 450 03-07	0407-0102	LC4 Super Moto 620 99	0407-0305
XC-W 200 16	0407-0103	XC 300 TPI Erzbergrodeo 20	0407-0103	EXC-R 450 08	0407-0102	RXC 620 96	0407-0104
EGS 250 95-96	0407-0104	XC 300 TPI Six Days 20	0407-0103	MXC-G 450 03-05	0407-0102	Super Moto 620 98	0407-0305
EGS 250 97	0407-0304	XC-W 300 06-15	0407-0102	SMR 450 05-07	0407-0102	SX 620 97-99	0407-0305
EGS 250 98-99	0407-0305	XC-W 300 16-19	0407-0103	SMR 450 14	0407-0102	SXC 620 97	0407-0305
EXC 250 95-96	0407-0104	XC-W 300 TPI 19-22	0407-0103	SMS 450 03	0407-0102	TXC 620 98	0407-0305
EXC 250 97	0407-0304	XC-W 300 Six Days 15	0407-0102	SX 450 03-06	0407-0102	SMC 625 04-06	0407-0102
EXC 250 98-99	0407-0305	XC-W 300 Six Days 16-18	0407-0103	SX-F 450 07-16	0407-0102	SXC 625 03-04	0407-0091
EXC 250 00-01	0407-0091	XC-W 300 TPI 19	0407-0103	SX-F 450 17-22	0407-0103	SXC 625 05	0407-0102
EXC 250 02	0407-0091 ¹	EXC-F 350 12-15	0407-0102	450 SX-F Factory Edition 15	0407-0102	640 LC4 Enduro 03-04	0407-0091
EXC 250 03-05	0407-0102	EXC-F 350 16-22	0407-0103	450 SX-F Factory Edition 16-21	0407-0103	Adventure 640 98-99	0407-0305
EXC-F 250 17-19	0407-0103	SX-F 350 11-16	0407-0102	SXS 450 03-04	0407-0102	Adventure 640 00	0407-0091
EXC-G 250 Racing 02	0407-0091	SX-F 350 17-22	0407-0103	XC 450 04	0407-0102	Adventure 640 01-07	0407-0102
EXC-G 250 Racing 03-05	0407-0102	XC-F 350 11-16	0407-0102	XC 450 06-07	0407-0102	LC4 640 05	0407-0102
Freeride 250 R 15-17	0407-0091	XC-F 350 17-22	0407-0103	XC-F 450 08-09	0407-0102	SC Super Moto 640 00-01	0407-0091
Freeride 250F 19	0407-0091	XC-FW 350 12-15	0407-0102	XC-F 450 13-16	0407-0102	Super Moto 640 99	0407-0305
MXC 250 98-99	0407-0305	XC-FW 350 16-22	0407-0103	XC-F 450 17-22	0407-0103	660 Rally Factory Repl. 06-07	0407-0102
MXC 250 00-01	0407-0091	XC-FW 350 Six Days 15	0407-0102	XC-W 450 Six Days 10	0407-0102	660 Rallye 01-05	0407-0102
SX 250 95-96	0407-0104	XC-FW 350 Six Days 16	0407-0103	XCR-W 450 08	0407-0102	660 Rally Factory Repl. 08-09	0407-0102
SX 250 97	0407-0304	EGS 360 96	0407-0104	XC-W 450 07-15	0407-0102	Enduro R 690 09-14	0407-0102
SX 250 98-99	0407-0305	EGS 360 97	0407-0304	XC-W 450 16	0407-0103	Enduro R 690 15	0407-0103
SX 250 00-01	0407-0091	EXC 360 96	0407-0104	EXC 500 12-15	0407-0102	690 Enduro 08	0407-0102
SX 250 02	0407-0091 ¹	EXC 360 97	0407-0304	EXC 500 16	0407-0103	SMC 690 09-10	0407-0102
SX 250 03-16	0407-0102	MXC 360 96	0407-0104	EXC 500 Six Days 16	0407-0103	Supermoto 690 07	0407-0102
SX 250 17-22	0407-0103	MXC 360 97	0407-0304	EXC-F 500 17-22	0407-0103	690R Enduro 15-20	0407-0103
SX-F 250 05-16	0407-0102	SX 360 96	0407-0104	EXC-F 500 Six Days 22	0407-0103	Adventure 790 19-20	0407-0091
SX-F 250 17-22	0407-0103	SX 360 97	0407-0304	XC-FW 500 21-22	0407-0103	Adventure 790R 20	0407-0103
250SX-F Factory Edition 15	0407-0102	EGS 380 98-99	0407-0305	XC-W 500 12-15	0407-0102	Adventure 890 21-22	0407-0091
SXS 250 01	0407-0091	EXC 380 98-99	0407-0305	XC-W 500 16	0407-0103	Adventure R 890 21-22	0407-0103
SXS 250 03-04	0407-0102	EXC 380 00-01	0407-0091	SX-F 505 08	0407-0102	Adventure R Rally 890 21	0407-0103
XC 250 06-16	0407-0102	EXC 380 02	0407-0091 ¹	XC-F 505 08-09	0407-0102	Adventure 950 04-06	0407-0102
XC 250 17-19	0407-0103	MXC 380 98-99	0407-0305	EXC 520 00-01	0407-0091	Super Enduro 950 07	0407-0102
XC 250 TPI 20-22	0407-0103	MXC 380 00-01	0407-0091	EXC 520 02	0407-0091 ¹	Supermoto 950 05-07	0407-0102
XC-F 250 07-09	0407-0102	SX 380 98-99	0407-0305	MXC 520 01	0407-0091	Adventure 990 07-13	0407-0102
XC-F 250 11-16	0407-0102	SX 380 00-01	0407-0091	MXC 520 02	0407-0091 ¹	Supermoto 990 10-11	0407-0102
XC-F 250 17-22	0407-0103	SX 380 02	0407-0091 ¹	SX 520 00-01	0407-0091	Adventure R 1090 18	0407-0103
XC-FW 250 06-15	0407-0102	Adventure 390 20-21	0407-0091	SX 520 02	0407-0091 ¹	Adventure 1190 14-16	0407-0103
XC-FW 250 16	0407-0103	EXC 400 00-02	0407-0091	EXC 525 03-07	0407-0102	1290 Super Adventure 15-16	0407-0103
XC-W 250 06-15	0407-0102	EXC-G 400 04-06	0407-0102	MXC-G 525 03-05	0407-0102	Super Adventure T 1290 17	0407-0103
XC-W 250 16-22	0407-0103	LC4 400 99	0407-0305	SMR 525 05	0407-0102		
XC-W 250 TPI 18-22	0407-0103	LC4-E 400 00-01	0407-0091				

¹ Fork dust seal kit only.

FORK AND DUST SEAL KITS continued on next page



FORK AND DUST SEAL KITS (CONT)

FITS MODEL	PART #	FITS MODEL	PART #	FITS MODEL	PART #	FITS MODEL	PART #
KTM (CONT)		SUZUKI (CONT)		TM		YAMAHA (CONT)	
1290 Super Adventure R 17-20	0407-0103	RM80 89-01	0407-0086 0407-0392 ¹	EN 125 96-04	0407-0104	WR200 92	0407-0174
1290 Super Adventure S 18-20	0407-0103	RM85 02-22	0407-0090	EN 125 09-11	0407-0304	TT225 86-87	0407-0087
MONTESA		RM85L 03-16	0407-0090	MX 125 96-04	0407-0104	TTR225 99-04	0407-0087
315R 00-04	0407-0316	RM100 03	0407-0089	MX 125 09-11	0407-0304	XT225 92-07	0407-0087
4RT 05-07	0407-0316	DR125 86-88	0407-0086 0407-0392 ¹	SMR 125 09	0407-0304	TTR230 05-17	0407-0087
RIEJU		DR125 86-88	0407-0086 0407-0392 ¹	EN 144 09-11	0407-0304	TTR230 19-22	0407-0087
MR Racing 250 21-22	0407-0103	DR125SE 94-02	0407-0086 0407-0392 ¹	MX 144 09-11	0407-0304	DT250 79	0407-0088
MR Racing 300 20-22	0407-0103	RM125 79-83	0407-0135	EN 250 96-04	0407-0104	IT250 77-80	0407-0088
SHERCO		RM125 84-87	0407-0178	EN 250 09-11	0407-0304	IT250 81-82	0407-0135
SM R 50 20-21	0407-0090	RM125 88	0407-0096	EN 250F 02-04	0407-0104	IT250 83	0407-0178
SE-R 125 18-21	0407-0103	RM125 89	0407-0097	EN 250F 09-11	0407-0304	TT250 80-82	0407-0088
SM 125 Factory 21	0407-0103	RM125 90	0407-0174	MX 250 96-04	0407-0104	TTR250 99-06	0407-0178
ST 125 Trials 15-18	0407-0701	RM125 91-95	0407-0179	MX 250 09-11	0407-0304	WR250 91-97	0407-0177
ST 125 Trials Factory 16	0407-0701	RM125 96-00	0407-0101	MX 250F 02-04	0407-0104	WR250F 01-04	0407-0098
ST 125 Factory/Racing 21	0407-0701	RM125 01-08	0407-0099	MX 250F 09-11	0407-0304	WR250F 05-21	0407-0103
Trials 1.25 99-14	0407-0701	SP125 86-88	0407-0086 0407-0392 ¹	EN 300 97-04	0407-0104	WR250R Dual Sport 08-20	0407-0098
Enduro 2.5i 08-11	0407-0307	PE175 82-84	0407-0135	EN 300 09-11	0407-0304	WR250X Supermoto 08-11	0407-0098
SE-F-R 250 14-18	0407-0103	DR200 86-88	0407-0086 0407-0392 ¹	MX 300 97-04	0407-0104	XT250 84	0407-0088
SC F-R 250 19	0407-0358	DR200 SE 96-17	0407-0086 0407-0392 ¹	MX 300 09-11	0407-0304	XT250 08-22	0407-0508 0407-0392 ¹
SC-R 250 19	0407-0358	DR200 S 18-20	0407-0086	EN 400F 02-03	0407-0104	YZ250 76	0407-0088
SE-F-R 250 Factory 16-19	0407-0103	SP200 86-88	0407-0086 0407-0392 ¹	MX 400F 02-03	0407-0104	YZ250 77-80	0407-0088
SE F-R Factory 19-21	0407-0358	DR250 90-93	0407-0319	EN 450F 04	0407-0104	YZ250 83-88	0407-0178
SE-R250 14-21	0407-0103	DR250S 90-95	0407-0319	EN 450F 09-11	0407-0304	YZ250 89-90	0407-0174
SE-R 250 Six Days	0407-0103	DRZ250 01-07	0407-0319	MX 450F 04	0407-0104	YZ250 91-95	0407-0177
ST 250 Trials 15-18	0407-0701	RM250 79-82	0407-0135	EN 530F 02-04	0407-0104	YZ250 96-03	0407-0098
ST 250 Trials Factory 16	0407-0701	RM250 83-87	0407-0178	EN 530F 09-11	0407-0304	YZ250 04-22	0407-0103
ST 250 Factory/Racing 21	0407-0701	RM250 88	0407-0096	MX 530F 02-04	0407-0104	YZ250F 01-03	0407-0098
Trials 2.5 99-11	0407-0701	RM250 89-90	0407-0174	EN 530F 09-11	0407-0304	YZ250F 04-22	0407-0103
ST 290 Trials 15	0407-0701	RM250 91-95	0407-0179	MX 530F 09-11	0407-0304	YZ250F 15-21	0407-0103
Trials 2.9 12-13	0407-0701	RM250 96-00	0407-0101	DT50 88-90	0407-0083	YZ250X 16-22	0407-0103
ST 300 Trials 15-18	0407-0701	RM250 01-03	0407-0098	DT50 (SA) 98	0407-0083	TT350 86-87	0407-0175
ST 300 Trials Factory 16	0407-0701	RM250 04-08	0407-0099	YZ65 18-20	0407-0089	XT350 85-00	0407-0088
ST 300 Factory/Replica/Racing 21	0407-0701	RMX250 89-90	0407-0174	YZ80 93-01	0407-0089	IT400 76-79	0407-0088
SE-F-R 300 14-18	0407-0103	RMX250 91-99	0407-0179	YZ85 02-22	0407-0089	WR400F 98-00	0407-0098
SE-F-R 300 Factory 16-20	0407-0103	RMZ250 04-06	0407-0103	YZ100 82-83	0407-0088	YZ400 76	0407-0088
SE-R 300 14-21	0407-0103	RMZ250 07-12	0407-0099	TTR110 08-22	0407-0387	YZ400F 77-79	0407-0135
SE F-R 300 Factory 21	0407-0358	RMZ250 13-22	0407-0103	DT X 125 05-06	0407-0093	YZ400F 98-99	0407-0098
SE-F-R 300 Six Days	0407-0103	DR350 90-99	0407-0319	DT125 99-06	0407-0093	IT425 80	0407-0088
Trails 3.0 13-15	0407-0701	DR350SE 90-99	0407-0319	TT125 00	0407-0083	WR426F 01-02	0407-0098
Trails 3.0 Factory 14	0407-0701	DRZ400E 00-07	0407-0101	TTR125 Drum Brake 00-03	0407-0083	YZ426F 00-02	0407-0098
SE-F-R 450 15-19	0407-0103	DRZ400S 00-22	0407-0101	TTR125E Drum Brake 03-07	0407-0083	WR450F 03-04	0407-0098
SC F-R 450 19-20	0407-0358	DRZ400SM 05-22	0407-0099	TTR125L Disc Brake 00-07	0407-0083	WR450F 05-21	0407-0103
SE-F-R 450 Factory 16-19	0407-0103	DRZ400S 00-03	0407-0101	TTR125LE Disc Brake 03-07	0407-0083	YZ450F 03	0407-0098
SE-F-R-450 Six Days 18	0407-0103	DRZ400S 00-20	0407-0101	XTZ 125 (SA) 03-10	0407-0086	YZ450F 04-22	0407-0103
SE F-R450 20	0407-0358	DRZ400SM 05-07	0407-0099	YZ125 77-80	0407-0088	YZ450FX 16-22	0407-0103
SE F-R450 21	0407-0103	RM400 79-80	0407-0135	YZ125 81-83	0407-0135	IT465 81-82	0407-0135
SE F-R450 Factory 20-21	0407-0358	RMX450 10-11	0407-0099	YZ125 84	0407-0094	YZ465 80	0407-0135
SX 2.5i 10	0407-0307	RMZ450 05-12	0407-0099	YZ125 85	0407-0319	IT490 83-84	0407-0178
Enduro 3.0i 10-11	0407-0307	RMZ450 13-14	0407-0103	YZ125 86-88	0407-0178	YZ490 83-90	0407-0178
Enduro 4.5i 04-11	0407-0307	RMZ450 15-22	0407-0101	YZ125 89-90	0407-0174	TT500 79-81	0407-0088
Supermotard 4.5i 04-08	0407-0307	RM465 81-82	0407-0178	YZ125 91-95	0407-0177	WR500 92-93	0407-0177
SEF 500 Factory 21	0407-0358	RM500 83-84	0407-0178	YZ125 96-03	0407-0098	XT500 80-82	0407-0088
SM 500 Factory 21	0407-0307	DR650RS 90-96	0407-0093	YZ125 04-22	0407-0103	TT600 83-86	0407-0178
Enduro 5.1i 07-11	0407-0307	DR650SE 90-95	0407-0093	YZ125X 20-22	0407-0103	XT600E 96-02	0407-0093
Supermotard 5.1i 07-08	0407-0307	DR650SE 96-17	0407-0178	IT175 77-81	0407-0088	1 Fork dust seal kit only.	
SUZUKI				IT175 83	0407-0135		
RM65 03-05	0407-0085 0407-0393 ¹			YZ175 76	0407-0088		
RM80 86-88	0407-0085 0407-0393 ¹			RT180 95-98	0407-0086 0407-0392 ¹		
				IT200 84-86	0407-0178		



METRIC BOLT KIT

- Ultimate kit for riders with multiple brands of bikes
- Wide variety of parts in kit enables you to help out your buddies
- Kit includes approximately 179 parts including bolts, nuts, factory hardware and more
- Fits many full-size late-model Japanese motocross and off-road motorcycles

DESCRIPTION	PART #
Metric bolt kit	2401-1567



EURO BOLT KIT

- Kit developed for 125-500 KTM
- Fits many Husqvarna, Husaberg, Beta and Gas Gas as well
- Comprised of 160 pieces including factory style KTM hardware, bolts, aluminum washers and concave washers, as well as dimpled flange bolts, carb screws, body screws, sprocket bolts, clips, valve stem parts and more

DESCRIPTION	PART #
Euro bolt kit	2401-1566



CR/CRF BOLT KIT

- Comprehensive kit designed for CR/CRF 125-450 models from 2000 to current
- Parts fit any Honda dirt bike
- All parts are factory-style replacements
- 193 piece kit includes rotor bolts, shroud bolts, seat bolts, subframe bolts, fork guard bolts, factory hardware, aluminum bushings, aluminum rim-lock spacers, sprocket bolts, Fuji nuts, misc washers, valve stem parts, hex-head bolts and more

DESCRIPTION	PART #
CR/CRF bolt kit	2401-1568



KX/KXF BOLT KIT

- The KX/KXF 154 piece Bolt Kit includes factory style hex flange bolts with captured washers, hex head flange bolts, shroud bolts, seat bolts, sub-frame bolts, fork guard bolts, rotor bolts, sprocket bolts, factory hardware, rim lock spacers, valve stem parts, chain guide parts, Fuji lock nuts, misc washers and an axle nut
- Fits Kawasaki KX/KXF model years 2003 to current
- Many parts will fit other Kawasaki dirt bikes

DESCRIPTION	PART #
KX/KXF bolt kit	2401-1570



RM/RMZ BOLT KIT

- The RM/RMZ Bolt Kit is intended for RM/RMZ 125-450 models from 2000 to current
- Many parts cross over for older models, DR models and other Suzuki dirt bikes
- Includes 169 pieces of hardware including shroud bolts, seat bolts, sub-frame bolts, fork guard bolts, rotor bolts, sprocket bolts, T-nuts, aluminum bushings, rim lock spacers, valve stem parts, Fuji lock nuts, replacement bolts, and misc. washers

DESCRIPTION	PART #
RM/RMZ bolt kit	2401-1571



YZ/YZF/WR BOLT KIT

- The YZ/YZF/WR Bolt Kit is developed for 2003 to current YZ/YZF/WR 125-450
- Crosses over to older models as well
- This 172 piece kit includes several hardware pieces, sprocket bolts, rotor bolts, valve stem parts, Fuji lock nuts, replacement bolts, misc. washers and more

DESCRIPTION	PART #
YZ/YZF/WR bolt kit	2401-1569



Includes clear FliteShield™ & RST purple ForceShield™

Includes dark smoke DropShield™



Glow in the dark

ECE 22.06

AIRFLITE™ CSF23

- Injection molded polycarbonate shell for strength
- Multiple oversized intake and exhaust ports are strategically placed to keep you cool and comfortable, including four intake vents, MX-inspired chinbar vent and two exhaust ports that channel air between the comfort liner and the protective, energy-absorbing EPS foam liner
- Quick-change, fog-free outer Fliteshield™ keeps debris away, while the internal, interchangeable; DropShield™ keeps the sun in check with a flip of a switch
- Removable molded breath deflector and chin curtain
- Moisture-wicking Hydradry™ interior is fully removable and washable
- Both wind drag and weight are decreased by sculpting the traditional neckline of the Airflite™ to avoid jacket or suit interference
- See helmet size guide on page 45 of the Parts Europe Helmet & Apparel Update v2 before ordering
- For replacement parts and accessories, see pages 98-109 of the Parts Europe Helmet & Apparel Update v2

NOTE: Does not ship with SAI, PSC or MFJ certification stickers unless purchased from an authorized dealer in that country.

CSF23

SIZE	PART #	SIZE	PART #	SIZE	PART #	SIZE	PART #
XS	0101-15064	M	0101-15066	XL	0101-15068	3XL	0101-15070
S	0101-15065	L	0101-15067	2XL	0101-15069		



A



Includes clear & RST silver
Icon Optics™ Shields



B



Includes clear & dark smoke
Icon Optics™ Shields



ECE 22.06

AIRFRAME™ PRO TOPSHELF

- Increased angle of attack designed to maintain visibility and stability
- Compressed, compact shape
- Sculpted neckline avoids jacket or suit interference
- Carbon fiber, Dyeema® and fiberglass composite shell for extra strength
- Oversized intake and exhaust ports vent hot air and help prevent fogging
- Removable molded breath deflector reduces shield fogging
- Icon Optics™ shield
- Prolock™ secure shield locking system
- Nine intake and five exhaust vents
- Rear spoiler for reduced helmet buffeting
- Fully removable Hydradry™ moisture wicking interior
- See helmet size guide on page 45 of the Parts Europe Helmet & Apparel Update v2 before ordering

NOTE: Does not ship with SAI or SG certification stickers unless purchased from an authorized dealer in that country.

PRO-OUTBREAK HELMETS

SIZE	(A) BLUE	SIZE	(A) BLUE
XS	0101-14944	XL	0101-14948
S	0101-14945	2XL	0101-14949
M	0101-14946	3XL	0101-14950
L	0101-14947		

PRO-TOPSHELF HELMETS

SIZE	(B) RED	SIZE	(B) RED
XS	0101-15071	XL	0101-15075
S	0101-15072	2XL	0101-15076
M	0101-15073	3XL	0101-15077
L	0101-15074		



A



B



C



Back view



UPSTATE MESH CE™ JACKET

- Comes with an Icon® relaxed fit that is constructed from durable 400D polyester and Iron Weave™ mesh chassis
- Includes YKK® zippers, 400D polyester reinforcements in elbows & shoulders, zipper cuffs
- Abrasion-resistant for optimal protection
- Complemented with removable D30® shoulder, elbow, and back impact protections
- Tested and certified according to EN 17092-4:2020 Class A

MESH CE

SIZE	(A) BLACK	(B) GREY	(C) GREEN
S	2820-6217	2820-6223	2820-6229
M	2820-6218	2820-6224	2820-6230
L	2820-6219	2820-6225	2820-6231

SIZE	(A) BLACK	(B) GREY	(C) GREEN
XL	2820-6220	2820-6226	2820-6232
2XL	2820-6221	2820-6227	2820-6233
3XL	2820-6222	2820-6228	2820-6234

UPSTATE MESH CE™ JACKET continued on next page



UPSTATE MESH CE™ JACKET (CONT)



A



Back view



B

CANVAS CE

SIZE	(A) BLACK	(B) GREY
S	2820-6235	2820-6241
M	2820-6236	2820-6242
L	2820-6237	2820-6243

SIZE	(A) BLACK	(B) GREY
XL	2820-6238	2820-6244
2XL	2820-6239	2820-6245
3XL	2820-6240	2820-6246



OJ MULTIPLO NECK WARMERS

- Stay warm in style
- Seamless polyester construction
- Variety of patterns available
- One size fits most



DESCRIPTION	PART #
Black	2502-0301