

OFFROAD 2025 UPDATE

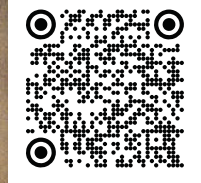

QUICKLY FIND
ALL THE PARTS
YOU NEED ON
OUR WEBSITE

PARTS EUROPE





A Look At What's New For 2025

Here is the 2025 Parts Europe Offroad catalogue update! This catalogue highlights new parts and accessories available for offroad enthusiasts, and their machines.

Be sure to keep the 2024 Parts Europe Offroad catalogue! You can still order from it. This update catalogue is designed to supplement the 2024 Offroad main catalogue.

For tires, tools, cleaners, lubes and service items, see the 2025 Parts Europe/Drag Specialties Tire, Tools & Chemicals catalogue update, along with the 2024 Parts Europe/Drag Specialties Tire, Tools & Chemicals catalogue.

For riding gear, helmets and casual apparel, see the 2025 Parts Europe/Drag Specialties Helmet & Apparel catalogue. We are still adding new products daily! Be sure to check partseurope.eu all year long to see what is new from Parts Europe.

Parts Europe – We support dealers, their customers and the sport!

All model designations and applications used herein are determined by the manufacturer as USA and/or European specific. Contact the individual manufacturer for additional international model information.



Table Of Contents

Exhaust	5-16	Brakes	89-105
Luggage	17-18	Wheels & Accessories	106-111
Bike Stands & Accessories	19-20	Suspension	112-127
Handlebars & Hand Controls	21-38	Electrical & Gauges	128-134
Footpegs & Foot Controls	39-44	Lighting	135-136
Body	45-59	Engine	137-151
Graphics & Seats	60-74	Fuel/Air Systems	152-159
Sprockets	75-83	Hardware & Merchandising	160
Chains	84-88		



Missing Something Here?

That's right and we did it on purpose!

To make your life easier, we have put together the almost endless selection of products from many popular top manufacturers in the clothing and equipment sector into our latest addition to the well-known PARTS EUROPE catalogue range. Find the huge selection of the latest helmets, eyewear, riding gear, accessories, apparel and rider protection from the top brands of the powersports business in our new **HELMET & APPAREL CATALOGUE 2025!**

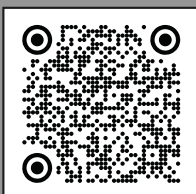
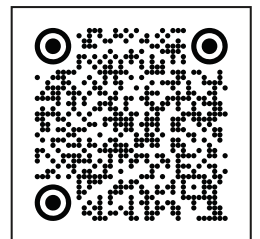

Discover The Hottest New Additions To Our Stock

IMPORTANT INFORMATION RELATING TO MANUFACTURER'S WARRANTY, EMISSION CONTROL REGULATION AND NOISE REGULATION INFORMATION:

DISCLAIMER: There is no warranty on exhaust pipes and mufflers with regard to any discoloration. Discoloration (blueing) is caused by tuning characteristics, i.e. timing, carburetor, fuel injection/controller settings, etc., and is not caused by defective manufacturing. See the Tires, Tools and Chemicals catalog for products that will help prevent and remove blueing.

DISCLAIMER: Products shown may be designed, manufactured, intended and sold for closed circuit race use only and use of the same on public roads or lands may be a violation of local, state and/or federal/EU laws.

DISCLAIMER: A number of regions have exhaust noise laws. Exhaust products advertised might not be legal for sale or use on public roads or lands in such jurisdictions. Check applicable laws and regulations.

DISCLAIMER: Check your applicable laws and manufacturer's publication(s) and/or website(s) for manufacturer's warranty, maintenance, safety, mounting and any regulatory compliance/non-compliance information.



1820-2045



1820-2048

FACTORY 4,1 RCT EXHAUST SYSTEMS

- RCT (Resonance Chamber Technology) features a core shape that lowers decibels while maintaining maximum power output
- Internal ducts in the chambers of the RCT system increase internal volume for improved exhaust flow, resulting in power gains throughout the entire range of power
- FMF's Factory Forward Engineering centralizes mass and is less prone to crash damage
- Innovative rear end cap features simple installation of tuning tip inserts or spark arrestor with the removal of four screws
- QuietCore 94 dB insert included
- Spark arrestor included in muffler
- Feature MegaBomb header and midpipe

- Available in natural titanium or blue anodized finish with titanium or carbon fiber end caps
- Meet AMA and FIM sound requirements
- See pages 6-7 of the 2024 Parts Europe Offroad catalog for additional Factory 4,1 RCT exhaust systems

REPLACEMENT END CAPS

DESCRIPTION	PART #
UNIVERSAL FIT	
Carbon endcaps (left and right)	1860-1787

FITS MODEL	DESCRIPTION	PART #
KAWASAKI		
KX450 24-25	Megabomb stainless steel gray anodized muffler with carbon fiber end cap	1820-2045
	Megabomb titanium blue anodized muffler with carbon end cap	1820-2046
YAMAHA		
YZ450F 23-25	Megabomb aluminum header gray anodized with black carbon fiber end cap	1820-2047
	Megabomb titanium header blue anodized with black carbon fiber end cap	1820-2048
WR450F 24	Megabomb aluminum header gray anodized with black carbon fiber end cap	1820-2047



1821-2102



1821-2093

FACTORY 4.1 RCT SLIP-ON MUFFLERS

- RCT (Resonance Chamber Technology) features a patented core shape that lowers decibels while maintaining maximum power output
- Internal ducts in the chambers of the RCT system increase internal volume for improved exhaust flow, resulting in power gains throughout the entire range of power
- FMF's Factory Forward Engineering centralizes mass and is less prone to crash damage
- Innovative rear end cap features simple installation of tuning tip inserts or spark arrestor with the removal of four screws

- Compatible with stock header or FMF header
- QuietCore 94dB insert included
- Spark arrestor included in muffler
- Available in natural titanium or blue anodized finish with titanium or carbon fiber end caps
- Meet AMA and FIM sound requirements
- See pages 8-9 of the 2024 Parts Europe Offroad catalog for additional Factory 4,1 RCT slip-on mufflers

FITS MODEL	DESCRIPTION	PART #
BETA		
RX 450 24-25	Blue titanium anodized with black carbon fiber end cap	1821-2102
KAWASAKI		
KX 450 24-25	Gray stainless steel w/ black carbon fiber end cap	1821-2093
	Blue anodized titanium with black carbon fiber end cap	1821-2094

DISCLAIMER: SEE PAGE 4 FOR IMPORTANT INFORMATION REGARDING CERTAIN WARRANTY AND EMISSION CONTROL REGULATION COMPLIANCE AND NOISE REGULATION INFORMATION.

EXHAUST

LUGGAGE

BIKE STANDS & ACCESSORIES

HANDLEBARS & HAND CONTROLS

FOOTPEGS & FOOT CONTROLS

BODY

GRAPHICS & SEATS

SPROCKETS

CHAINS

BRAKES

WHEELS & ACCESSORIES

SUSPENSION

ELECTRICAL & GAUGES

LIGHTING

ENGINE

FUEL/AIR SYSTEMS

HARDWARE & MERCHANDISING



EXHAUST

LUGGAGE

BIKE STANDS & ACCESSORIES

HANDLEBARS & HAND CONTROLS

FOOTPEGS & FOOT CONTROLS

BODY

GRAPHICS & SEATS

SPROCKETS

CHAINS

BRAKES

WHEELS & ACCESSORIES

SUSPENSION

ELECTRICAL & GAUGES

LIGHTING

ENGINE

FUEL/AIR SYSTEMS

HARDWARE & MERCHANDISING



THE Q SERIES

Q4 HEX

FOR KAWASAKI KX 450F 24-25

- Less sound equals more ground
- Meets FIM World Enduro sound regulations
- Power gains throughout the entire rpm range
- Spark arrestor included
- Pounds lighter than stock
- Rugged design for off-road endurance

• See page 10 of the 2024 Parts Europe Offroad catalog for additional Q Series exhaust systems

NOTE: FOR CLOSED COURSE COMPETITION USE ONLY. NOT INTENDED FOR STREET USE.

DESCRIPTION

Q4 Hex slip-on muffler

PART

1821-2092



POWERCORE 4

FOR KAWASAKI KX 450 24-25

- Hi-Flo end cap boosts all-around performance
- Computer-designed and dyno-tested for every 4-stroke application
- Enhanced sonic evacuation delivers a higher flow of exhaust gases, which increases power
- A stainless steel mid-pipe mates to the computer-designed rear can for lightweight durability
- Round perforated steel inner cores make for optimum flow, using hi-flo technology
- FMF's exclusive cross-weave internal packing provides longevity and maximum sound dispersion
- Elliptical aluminum can offers strategic sizing for superior performance

• Optional Quiet Core insert will provide a decrease in sound level if desired

• Features a screen-type spark arrestor that does not interrupt exhaust flow or performance

• See page 11 of the 2024 Parts Europe Offroad catalog for additional Powercore 4 slip-on mufflers

DESCRIPTION

Powercore 4 slip-on muffler

PART

1821-2091

DISCLAIMER: SEE PAGE 4 FOR IMPORTANT INFORMATION REGARDING CERTAIN WARRANTY AND EMISSION CONTROL REGULATION COMPLIANCE AND NOISE REGULATION INFORMATION.



EXHAUST

LUGGAGE

BIKE STANDS & ACCESSORIES

HANDLEBARS & HAND CONTROLS

FOOTPEGS & FOOT CONTROLS

BODY

GRAPHICS & SEATS

SPROCKETS

CHAINS

BRAKES

WHEELS & ACCESSORIES

SUSPENSION

ELECTRICAL & GAUGES

LIGHTING

ENGINE

FUEL/AIR SYSTEMS

HARDWARE & MERCHANDISING

MEGABOMB HEADERS STAINLESS STEEL AND TITANIUM

- The ultimate power boosters
- Improved bottom to mid-range power
- Produce the low end of a longer header and the top end of a short header
- Less susceptible to damage than a long header
- Effectively reduce sound output by as much as 1,5 dB
- Run well with sound-restricting mufflers
- Available in stainless steel or FMF's exclusive Ti-Metal construction
- See page 13 of the 2024 Parts Europe Offroad catalog for additional Megabomb headers

FITS MODEL	DESCRIPTION	PART #
BETA		
RX 450 24-25	Titanium header	1822-0551

FITS MODEL	DESCRIPTION	PART #
KAWASAKI		
KX 450 24	Stainless steel header	1822-0549
	Titanium header	1822-0550



POWERCORE 2 SILENCER FOR KAWASAKI KX 500 88-04

- Lightweight and compact silencer constructed of an extruded aluminum canister with nickel plated stinger and end cap
- Enhance exhaust flow and improve overall performance
- See page 19 of the 2024 Parts Europe Offroad catalog for additional Powercore 2 silencers

FITS MODEL	PART #
Powercore 2 Silencer	1821-2088



TURBINECORE 2 SPARK ARRESTOR SILENCER FOR KAWASAKI KX 500 88, 96-04

- Straight-through design of the spark arrestor canister and the Performance Flow stainless steel end cap ensure strength, durability and unrestricted power
- See page 22 of the 2024 Parts Europe Offroad catalog for additional Turbinecore 2 spark arrestor silencers

DESCRIPTION	PART #
Spark Arrestor Silencer	1821-2089

DISCLAIMER: SEE PAGE 4 FOR IMPORTANT INFORMATION REGARDING CERTAIN WARRANTY AND EMISSION CONTROL REGULATION COMPLIANCE AND NOISE REGULATION INFORMATION.



1820-2040

Ti-6 AND T-6 4-STROKE EXHAUST SYSTEMS FOR KAWASAKI KX 450 24-25

- Ti-6 Pro titanium exhaust system is perfect for you; created as a full race system, the Ti-6 Pro is designed to increase performance and help professional racers pass FIM sound regulations
- Ti-6 titanium exhaust system is designed to improve performance and power; constructed of titanium throughout the headpipe, mid pipe and canister; this is the ideal exhaust for any offroad or closed course racer looking for improved performance, durability and a professional look; comes with a removable spark arrestor making it easy to alternate between off-road and closed course riding
- T-6 stainless steel exhaust system offers the same benefits as Ti-6 titanium exhaust system, but the T-6 is constructed of stainless steel and aluminum for increased strength and durability while giving riders a more affordable alternative to titanium; comes with a removable spark arrestor making it easy to alternate between off-road and closed course riding

- All T-6 Euro exhaust systems pass FIM sound regulations
- Machined aluminum muffler brackets for increased strength and durability
- Asymmetrical muffler configuration for increased packing volume
- Most systems equipped with a RC-4 Resonance Chamber for reduced sound output
- Machined mid pipe to headpipe joint for a better, leak-free fit
- TIG precision welding
- For the full line of Ti-6 and T-6 exhaust systems see pages 26-27 of the 2024 Parts Europe Offroad catalog

DESCRIPTION	PART #	DESCRIPTION	PART #
T-6 stainless system	1820-2037	Ti-6 w/ carbon end cap	1820-2038
T-6 stainless system w/ titanium shell and carbon end cap	1820-2040	Ti-6 Pro w/ carbon end cap	1820-2039



T-6 SLIP-ON FOR KAWASAKI KX 450 24-25

- T-6 Stainless Slip-On Silencers are designed for a rider looking for an inexpensive, easy-to-install, durable performance silencer that can bolt onto their stock headpipe
- Constructed of stainless steel throughout the mid-pipe and end-cap while the canister is constructed of aluminum for increased durability
- Machined aluminum muffler bracket for increased strength and durability
- Asymmetrical muffler configuration for increased packing volume

- Removable spark arrestor
- TIG precision welding
- For the full line of T6 Slip-on exhaust systems see page 28 of the 2024 Parts Europe Offroad catalog

DESCRIPTION	PART #
T-6 Stainless slip-on silencer w/ removable spark arrestor	1821-2087

DISCLAIMER: SEE PAGE 4 FOR IMPORTANT INFORMATION REGARDING CERTAIN WARRANTY AND EMISSION CONTROL REGULATION COMPLIANCE AND NOISE REGULATION INFORMATION.



1822-0552

EXHAUST

LUGGAGE

BIKE STANDS & ACCESSORIES

HANDLEBARS & HAND CONTROLS

FOOTPEGS & FOOT CONTROLS

BODY

GRAPHICS & SEATS

SPROCKETS

CHAINS

BRAKES

WHEELS & ACCESSORIES

SUSPENSION

ELECTRICAL & GAUGES

LIGHTING

ENGINE

FUEL/AIR SYSTEMS

HARDWARE & MERCHANDISING

WORKS PIPES

- The original Pro Circuit Works pipe offers unparalleled performance and power for every two-stroke application
- Increased horsepower and torque gains will quickly be noticed across the entire rpm range
- The unplated, oiled metal finish requires some maintenance, but really gives your bike that "Works Look"
- For the full line of Works Pipes see page 31 of the 2024 Parts Europe Offroad catalog

FITS MODEL	PART #	FITS MODEL	PART #	FITS MODEL	PART #
GASGAS		HUSQVARNA		KTM	
MC 65 24-25	1822-0552	TC 65 24-25	1822-0552	SX 65 24-25	1822-0552



1822-0553

PLATINUM PIPES

- Inspired by the championship winning Works pipe, the Platinum series pipe utilizes plating on the body to protect it from everyday wear and tear
- Unique nickel bath technology gives the surface added abrasion resistance and enhances the aesthetic look
- Stamped AKDQ high-quality carbon steel construction for exceptional fit and performance
- Hand-welded and pounded seams
- Embossed name plate and CNC-machined exhaust flange
- Reinforced mounting brackets and stinger for increased strength and durability
- For the full line of Platinum Pipes exhaust systems see page 32 of the 2024 Parts Europe Offroad catalog

FITS MODEL	PART #	FITS MODEL	PART #	FITS MODEL	PART #
GASGAS		HUSQVARNA		KTM	
MC 65 24-25	1822-0553	TC 65 24-25	1822-0553	SX 65 24-25	1822-0553

DISCLAIMER: SEE PAGE 4 FOR IMPORTANT INFORMATION REGARDING CERTAIN WARRANTY AND EMISSION CONTROL REGULATION COMPLIANCE AND NOISE REGULATION INFORMATION.



EXHAUST

LUGGAGE

BIKE STANDS & ACCESSORIES

HANDLEBARS & HAND CONTROLS

FOOTPEGS & FOOT CONTROLS

BODY

GRAPHICS & SEATS

SPROCKETS

CHAINS

BRAKES

WHEELS & ACCESSORIES

SUSPENSION

ELECTRICAL & GAUGES

LIGHTING

ENGINE

FUEL/AIR SYSTEMS

HARDWARE & MERCHANDISING



1821-2104



1821-2105

R304 SHORTY AND R304 SHORTY Ti-2 CARBON-ARAMID FIBER SILENCERS

- Canister is made of lightweight 6061-T6 aluminum with brushed finish
- High-strength aluminum rivets and R304 Shorty features steel Allen-head screws for easy disassembly and repacking
- Double-walled mounting brackets
- Exclusive E-glass pillow packing
- PC logo detailing
- Carbon-aramid fiber silencers feature a carbon-aramid fiber shell, titanium tubing and titanium end caps; optimum performance gains while reducing weight
- For the full line of R304 Shorty exhaust systems see page 33 of the 2024 Parts Europe Offroad catalog

FITS MODEL	DESCRIPTION	PART #	FITS MODEL	DESCRIPTION	PART #	FITS MODEL	DESCRIPTION	PART #
GASGAS			HUSQVARNA			KTM		
MC 65 24-25	R304 Shorty	1821-2104	TC 65 24-25	R304 Shorty	1821-2104	SX 65 24-25	R304 Shorty	1821-2104
	Ti-2 Shorty	1821-2105		Ti-2 Shorty	1821-2105		Ti-2 Shorty	1821-2105



1821-2103

304 FACTORY SOUND SILENCERS

- Feature a longer midsection than the R-304 Shorty for stronger mid-to-high-rpm performance
- Excellent replacement for the OEM silencer, while offering impressive performance gains
- 6061-T6 brushed aluminum housing
- Double-walled mounting brackets
- Stainless steel tubing and end-cap
- Steel Allen-head screws for easy rebuilding/repacking
- Exclusive E-glass pillow packing
- For the full line of 304 Factory Sound silencers see page 34 of the 2024 Parts Europe Offroad catalog

FITS MODEL	PART #	FITS MODEL	PART #	FITS MODEL	PART #
GASGAS		HUSQVARNA		KTM	
MC 65 24-25	1821-2103	TC 65 24-25	1821-2103	SX 65 24-25	1821-2103



1821-2106

TYPE 296 SPARK ARRESTOR SILENCERS

- Includes spark arrestor while maximizing performance
- 96 dB sound level
- Specially engineered internal metal baffle, chambers and sound-absorbing materials for lower sound levels and no loss of motor performance
- FIM-approved stainless steel end cap
- Silencer body is made from extruded 6061-T6 aluminum to reduce weight
- Removable allen-head screws make repacking an easy task
- Double-walled mounting brackets
- For the full line of Type 296 silencers see page 35 of the 2024 Parts Europe Offroad catalog

FITS MODEL	PART #	FITS MODEL	PART #	FITS MODEL	PART #
GASGAS		HUSQVARNA		KTM	
MC 65 24-25	1821-2106	TC 65 24-25	1821-2106	SX 65 24-25	1821-2106

DISCLAIMER: SEE PAGE 4 FOR IMPORTANT INFORMATION REGARDING CERTAIN WARRANTY AND EMISSION CONTROL REGULATION COMPLIANCE AND NOISE REGULATION INFORMATION.



1820-2052



1820-2041

EVOLUTION LINE COMPLETE EXHAUST SYSTEMS

- The flagship of the Akrapovic exhaust system range
- Used and tested by top factory teams in motorcycle racing
- Each model is unique and dedicated to maximizing the engine's performance, while reducing overall weight for optimized overall handling of the motorcycle
- Made entirely of titanium
- Exhaust systems meet FIM noise limits, and feature a more durable welded bracket and titanium end cap

- Performance exhaust systems also feature a new coating for the silencer outer sleeve giving better scratch resistance and easier cleaning
- See page 37 of the 2024 Parts Europe Offroad catalog for the complete line of Akrapovic Evolution exhaust systems

FITS MODEL	PART #
KAWASAKI	
KX 450/X 24-25	1820-2052

FITS MODEL	PART #
YAMAHA	
YZ 250F 24-25	1820-2041
WR 250F 24-25	1820-2041



1860-0979

1860-0984

1860-2452

1861-1748

REPLACEMENT PARTS

- Replace lost or damaged exhaust parts
- Listed by Akrapovic replacement #
- Muffler repack kits include dampening material, tapes, rivets and stickers

- Sold each
- See page 38 of the 2024 Parts Europe Offroad catalog for the complete line of Akrapovic exhaust replacement parts

AKRAPOVIČ #	PART #	AKRAPOVIČ #	PART #	AKRAPOVIČ #	PART #
END CAPS		MUFFLER REPACK KITS		NOISE DAMPER	
V-EC186	1860-0979	P-RPCK275	1861-1748	V-TUV062/TI/1	1860-0984
V-EC187	1860-0980	P-RPCK301	1861-1749	NOISE INSERT	
V-EC207	1860-0982			V-TUV349	1860-2452

DISCLAIMER: SEE PAGE 4 FOR IMPORTANT INFORMATION REGARDING CERTAIN WARRANTY AND EMISSION CONTROL REGULATION COMPLIANCE AND NOISE REGULATION INFORMATION.

- EXHAUST
- LUGGAGE
- BIKE STANDS & ACCESSORIES
- HANDLEBARS & HAND CONTROLS
- FOOTPEGS & FOOT CONTROLS
- BODY
- GRAPHICS & SEATS
- SPROCKETS
- CHAINS
- BRAKES
- WHEELS & ACCESSORIES
- SUSPENSION
- ELECTRICAL & GAUGES
- LIGHTING
- ENGINE
- FUEL/AIR SYSTEMS
- HARDWARE & MERCHANDISING

EXHAUST

LUGGAGE

BIKE
STANDS &
ACCESSORIESHANDLEBARS
& HAND
CONTROLSFOOTPEGS
& FOOT
CONTROLS

BODY

GRAPHICS
& SEATS

SPROCKETS

CHAINS

BRAKES

WHEELS &
ACCESSORIES

SUSPENSION

ELECTRICAL
& GAUGES

LIGHTING

ENGINE

FUEL/AIR
SYSTEMSHARDWARE &
MERCHANDISING

1821-2126



1822-0554

4-STROKE SILENCERS

- High-performance aluminium silencer
- Steel or carbon end cap options
- Lighter than stock silencer
- Increases horse power

**NOTE: Enduro silencers mount on HGS head pipes only.
Slip-on silencers mount of OE head pipes only.**

4-STROKE HEAD PIPES

- High-performance hand-made 4-stroke steel head pipe
- Increases horse power
- Lighter than stock exhaust

FITS MODEL	HEADPIPE PART #	MIDPIPE PART #	ALU GRAY SILENCER W/ STEEL END CAP PART #	ALU BLACK SILENCER W/ STEEL END CAP PART #	SLIP-ON SILENCER (MOUNTS ON OE HEADPIPES ONLY) PART #
GASGAS					
MC 250F 21-23	1822-0555	-	1821-2126	1821-2127	-
MC 250F 24-25	1822-0554	-	1821-2124	1821-2125	-
MC 350F 21-23	1822-0561	-	1821-2126	-	-
MC 350F 24-25	1822-0560	-	-	-	-
MC 450F 21-23	1822-0567	-	1821-2126	-	-
MC 450F 24-25	1822-0566	-	-	-	-
EC 250F 21-23	1822-0555	-	1821-2135 ¹	-	-
EC 250F 24-25	1822-0554	-	1821-2150 ¹	-	1821-2134 ²
EC 350F 21-23	1822-0561	-	1821-2135 ¹	-	-
EC 350F 24-25	1822-0560	-	1821-2151 ¹	-	-
EC 450/500F 24-25	1822-0566	-	1821-2150	-	1821-2134 ²
HUSQVARNA					
FC 250 14-15	1822-0558	1822-0559	1821-2129	-	-
FC 250 16-18	1822-0556	1822-0557	1821-2128	-	-
FC 250 19-22	1822-0555	-	1821-2126	1821-2127	-
FC 250 23-25	1822-0554	-	1821-2124	1821-2125	-
FC 350 14-15	1822-0564	1822-0565	1821-2132	-	-
FC 350 16-18	1822-0562	1822-0563	1821-2131	-	-
FC 350 19-22	1822-0561	-	1821-2126	-	-
FC 350 23-25	1822-0560	-	-	-	-
FC 450 14-15	1822-0570	1822-0571	1821-2133	-	-
FC 450 16-18	1822-0568	1822-0569	1821-2131	-	-
FC 450 19-22	1822-0567	-	1821-2126	-	-
FC 450 23-25	1822-0566	-	-	-	-
FE 250 15-16	1822-0558	1822-0559	1821-2137 ¹	-	-
FE 250 17-19	1822-0556	1822-0557	1821-2136 ¹	-	-
FE 250 20-23	1822-0555	-	1821-2135 ¹	-	-
FE 250 24-25	1822-0554	-	1821-2150 ¹	-	1821-2134 ²
FE 350 15-16	1822-0564	1822-0565	-	-	-
FE 350 17-19	1822-0562	1822-0563	1821-2152 ¹	-	-
FE 350 20-23	1822-0561	-	1821-2135 ¹	-	-
FE 350 24-25	1822-0560	-	1821-2151 ¹	-	-
FE 450/501 15-16	1822-0570	1822-0571	1821-2138 ¹	-	-
FE 450/501 17-19	1822-0568	1822-0569	1821-2152 ¹	-	-
FE 450/501 20-23	1822-0567	-	1821-2135 ¹	-	-
FE 450/501 24-25	1822-0566	-	1821-2150	-	1821-2134 ²

¹ Mounts on HGS head pipe only.

² Mounts on OE head pipe only.

DISCLAIMER: SEE PAGE 4 FOR IMPORTANT INFORMATION REGARDING CERTAIN WARRANTY AND EMISSION CONTROL REGULATION COMPLIANCE AND NOISE REGULATION INFORMATION.



4-STROKE SILENCERS AND 4-STROKE HEAD PIPES (CONT)

FITS MODEL	HEADPIPE PART #	MIDPIPE PART #	ALU GRAY SILENCER W/ STEEL END CAP PART #	ALU BLACK SILENCER W/ STEEL END CAP PART #	SLIP-ON SILENCER (MOUNTS ON OE HEADPIPES ONLY) PART #
KTM					
SX-F 250 13-15	1822-0558	1822-0559	1821-2129	-	-
SX-F 250 16-18	1822-0556	1822-0557	1821-2128	-	-
SX-F 250 19-22	1822-0555	-	1821-2126	1821-2127	-
SX-F 250 23-25	1822-0554	-	1821-2124	1821-2125	-
SX-F 350 13-15	1822-0564	1822-0565	1821-2132	-	-
SX-F 350 16-18	1822-0562	1822-0563	1821-2131	-	-
SX-F 350 19-22	1822-0561	-	1821-2126	-	-
SX-F 350 23-25	1822-0560	-	-	-	-
SX-F 450 13-15	1822-0570	-	1821-2133	-	-
SX-F 450 16-18	1822-0568	1822-0569	1821-2131	-	-
SX-F 450 19-22	1822-0567	-	1821-2126	-	-
SX-F 450 23-25	1822-0566	-	-	-	-
EXC-F 250 14-16	1822-0558	1822-0559	1821-2137 ¹	-	-
EXC-F 250 17-19	1822-0556	1822-0557	1821-2136 ¹	-	-
EXC-F 250 20-23	1822-0561	-	1821-2135 ¹	-	-
EXC-F 250 24-25	1822-0554	-	1821-2150 ¹	-	1821-2134 ²
EXC-F 350 15-16	1822-0564	1822-0565	-	-	-
EXC-F 350 17-19	1822-0562	1822-0563	1821-2152 ¹	-	-
EXC-F 350 20-23	1822-0561	-	1821-2135 ¹	-	-
EXC-F 350 24-25	1822-0560	-	1821-2151 ¹	-	1821-2134 ²
EXC-F 450/501 14-16	1822-0570	1822-0571	1821-2138 ¹	-	-
EXC-F 450/501 17-19	1822-0568	1822-0569	1821-2152 ¹	-	-
EXC-F 450/500 20-23	1822-0567	-	1821-2135 ¹	-	-
EXC-F 450/500 24-25	1822-0566	-	1821-2150 ¹	-	1821-2134 ²

¹ Mounts on HGS head pipe only.

² Mounts on OE head pipe only.



2-STROKE PIPES

- High-performance hand-made 2-stroke steel exhaust
- Increases horse power
- Lighter than stock exhaust

2-STROKE SILENCERS

- High-performance aluminium silencer
- Steel or carbon end cap options
- Lighter than stock silencer
- Increases horse power

FITS MODEL	PIPE PART #	ALU GRAY SILENCER W/ STEEL END CAP PART #	ALU BLACK SILENCER W/ STEEL END CAP PART #	ALU ORANGE SILENCER W/ STEEL END CAP PART #	ALU BLACK SILENCER W/ CARBON END CAP PART #	ALU ORANGE SILENCER W/ CARBON END CAP PART #
GASGAS						
MC 50 21-23	1820-2056	1821-2109	-	-	-	-
MC 50 24-25	1820-2055	1821-2108	-	-	-	-
MC 65 21-23	1820-2058	1821-2112	-	-	-	-
MC 65 24-25	1820-2057	1821-2110	-	-	1821-2111	-
MC 65 high rpm 24-25	1820-2073	1821-2110	-	-	1821-2111	-
MC 85 21-24	1820-2059	1821-2113	-	-	1821-2114	-
MC 85 25	1820-2070	1821-2139	1821-2141	-	1821-2143	-
MC 125 21-23	1820-2062	1821-2118	-	-	-	-
MC 125 24-25	1820-2061	1821-2116	-	-	1821-2117	-
MC 250 21-23	1820-2066	1821-2122 ¹	-	-	-	-

¹ Round silencer.

2-STROKE SILENCERS AND 2-STROKE HEAD PIPES continued on next page.

DISCLAIMER: SEE PAGE 4 FOR IMPORTANT INFORMATION REGARDING CERTAIN WARRANTY AND EMISSION CONTROL REGULATION COMPLIANCE AND NOISE REGULATION INFORMATION.

EXHAUST

LUGGAGE

BIKE STANDS & ACCESSORIES

HANDLEBARS & HAND CONTROLS

FOOTPEGS & FOOT CONTROLS

BODY

GRAPHICS & SEATS

SPROCKETS

CHAINS

BRAKES

WHEELS & ACCESSORIES

SUSPENSION

ELECTRICAL & GAUGES

LIGHTING

ENGINE

FUEL/AIR SYSTEMS

HARDWARE & MERCHANDISING



2-STROKE PIPES AND 2-STROKE SILENCERS (CONT)

	FITS MODEL	PIPE PART #	ALU GRAY SILENCER W/ STEEL END CAP PART #	ALU BLACK SILENCER W/ STEEL END CAP PART #	ALU ORANGE SILENCER W/ STEEL END CAP PART #	ALU BLACK SILENCER W/ CARBON END CAP PART #	ALU ORANGE SILENCER W/ CARBON END CAP PART #
	GASGAS (CONT)						
	MC 250/300 24-25	1820-2065	1821-2121 ¹	-	-	-	-
	EC 250/300 21-23	1820-2066	1821-2148 ²	-	-	-	-
	EC 250/300 24-25	1820-2069	1821-2147 ²	-	-	-	-
	HUSQVARNA						
	TC 50 17-23	1820-2056	1821-2109	-	-	-	-
	TC 50 24-25	1820-2055	1821-2108	-	-	-	-
	TC 65 17-23	1820-2058	1821-2112	-	-	-	-
	TC 65 24-25	1820-2057	1821-2110	-	-	1821-2111	-
	TC 65 high rpm 24-25	1820-2073	1821-2110	-	-	1821-2111	-
	TC 85 14-17	1820-2060	1821-2115	-	-	-	-
	TC 85 18-24	1820-2059	1821-2113	-	-	1821-2114	-
	TC 85 25	1820-2070	1821-2139	1821-2141	-	1821-2143	-
	TC 125 14-15	1820-2064	1821-2120	-	-	-	-
	TC 125 16-18	1820-2063	1821-2119	-	-	-	-
	TC 125 19-22	1820-2062	1821-2118	-	-	-	-
	TC 125 23-25	1820-2061	1821-2116	-	-	1821-2117	-
	TC 250 17-18	1820-2067	1821-2123 ¹	-	-	-	-
	TC 250 19-22	1820-2066	1821-2122 ¹	-	-	-	-
	TC 250 23-25	1820-2065	1821-2121 ¹	-	-	-	-
	TE 125 14-16	1820-2064	1821-2145 ²	-	-	-	-
	TE 125 17-19	1820-2063	1821-2144 ²	-	-	-	-
	TE 150i 20-25	1820-2068	1821-2146 ²	-	-	-	-
	TE 250/300 17-19	1820-2067	1821-2149 ²	-	-	-	-
	TE 250/300 20-23	1820-2066	1821-2148 ²	-	-	-	-
	TE 250/300 24-25	1820-2069	1821-2147 ²	-	-	-	-
	KTM						
	SX 50 09-23	1820-2056	1821-2109	-	-	-	-
	SX 50 24-25	1820-2055	1821-2108	-	-	-	-
	SX 65 16-23	1820-2058	1821-2112	-	-	-	-
	SX 65 24-25	1820-2057	1821-2110	-	-	1821-2111	-
	SX 65 high rpm 24-25	1820-2073	1821-2110	-	-	1821-2111	-
	SX 85 04-17	1820-2060	1821-2115	-	-	-	-
	SX 85 18-24	1820-2059	1821-2113	-	-	1821-2114	-
	SX 85 25	1820-2070	1821-2139	1821-2141	1821-2140	1821-2143	1821-2142
	SX 125 12-15	1820-2064	1821-2120	-	-	-	-
	SX 125 16-18	1820-2063	1821-2119	-	-	-	-
	SX 125 19-22	1820-2062	1821-2118	-	-	-	-
	SX 125 23-25	1820-2061	1821-2116	-	-	1821-2117	-
	SX 250 17-18	1820-2067	1821-2123 ¹	-	-	-	-
	SX 250/300 19-22	1820-2066	1821-2122 ¹	-	-	-	-
	SX 250/300 23-25	1820-2065	1821-2121 ¹	-	-	-	-
	EXC 125 13-16	1820-2064	1821-2145 ²	-	-	-	-
	EXC 125 17-19	1820-2063	1821-2144 ²	-	-	-	-
	EXC 150 TPI 20-25	1820-2068	1821-2146 ²	-	-	-	-
	EXC 250/300 17-19	1820-2067	1821-2149 ²	-	-	-	-
	EXC 250/300 20-23	1820-2066	1821-2148 ²	-	-	-	-
	EXC 250/300 24-25	1820-2069	1821-2147 ²	-	-	-	-

¹ Round silencer.

² Enduro silencer.

REPLACEMENT END CAPS AND SILENCER REFILL KITS

DESCRIPTION	PART #	DESCRIPTION	PART #
CARBON FIBER END CAPS		SILENCER REFILL KITS	
65-85 cc 2-stroke silencers	1860-2486	65/85 cc 2-stroke silencers	1860-2482
125-250 cc 2-stroke silencers	1860-2487	125/150 cc 2-stroke silencers	1860-2483
4-stroke silencers	1860-2488	250/300 cc 2-stroke silencers	1860-2484
STAINLESS STEEL END CAPS		4-stroke silencers	1860-2485
50 cc 2-stroke silencers (60 mm)	1860-2489		
65/85/125 cc 2-stroke silencers (70 mm)	1860-2490		
250 cc 2-stroke silencers (70 mm)	1860-2491		

DISCLAIMER: SEE PAGE 4 FOR IMPORTANT INFORMATION REGARDING CERTAIN WARRANTY AND EMISSION CONTROL REGULATION COMPLIANCE AND NOISE REGULATION INFORMATION.

EXHAUST

LUGGAGE

BIKE STANDS & ACCESSORIES

HANDLEBARS & HAND CONTROLS

FOOTPEGS & FOOT CONTROLS

BODY

GRAPHICS & SEATS

SPROCKETS

CHAINS

BRAKES

WHEELS & ACCESSORIES

SUSPENSION

ELECTRICAL & GAUGES

LIGHTING

ENGINE

FUEL/AIR SYSTEMS

HARDWARE & MERCHANDISING



1821-2099



1821-2098



X3 EVO SLIP-ON MUFFLERS

- Hand made from AISI 304 stainless steel, TIG-welded for long-lasting performance
- Media-blasted for a perfect textured surface finish
- Lightweight carbon fiber end cap
- Welded mounting brackets with rubber damper or carbon fiber strap offering strength and reliability
- USFS-approved spark arrester included
- Meets USFS and FIM World Enduro sound regulations
- Straight-through race-developed muffler core, to unleash a deep sound
- Industry-leading muffler repack intervals due to the highest quality and density of packing material
- Optimized torque, more usable performance
- Wash plug included in the box
- Made in Europe
- Please see page 41 of the 2024 Parts Europe Offroad catalog for Leo Vince's full line of X3 Evo slip-on mufflers

FITS MODEL	PART #	FITS MODEL	PART #	FITS MODEL	PART #
BETA		HUSQVARNA		KTM	
RR 350/390/430/480 Racing 4T 20-25	1821-2099	FE 250/350/450/501 24-25	1821-2098	EXC-F 250/350/450/500 24-25	1821-2098



ADVENTURE BIKE UNIVERSAL MUFFLER HEAT SHIELDS

- Prevents side panels and soft bags from touching bike's hot exhaust
- Easy clamp-on design with stainless steel hose clamp (included)
- Universal fitment; fits most Original Equipment mufflers
- Tough 5052 laser-cut aluminum



DESCRIPTION	PART #	DESCRIPTION	PART #
Small: 15 cm x 76 mm (6" x 3")	1861-1726	Large: 20,5 cm x 89 mm (8" x 3,5")	1861-1727

DISCLAIMER: SEE PAGE 4 FOR IMPORTANT INFORMATION REGARDING CERTAIN WARRANTY AND EMISSION CONTROL REGULATION COMPLIANCE AND NOISE REGULATION INFORMATION.



EXHAUST

LUGGAGE

BIKE STANDS & ACCESSORIES

HANDLEBARS & HAND CONTROLS

FOOTPEGS & FOOT CONTROLS

BODY

GRAPHICS & SEATS

SPROCKETS

CHAINS

BRAKES

WHEELS & ACCESSORIES

SUSPENSION

ELECTRICAL & GAUGES

LIGHTING

ENGINE

FUEL/AIR SYSTEMS

HARDWARE & MERCHANDISING



1861-1744



1861-1730

PIPE GUARDS BY E-LINE

- Moose Racing pipe guards offer the most protection, style and durability on the market
- Custom-molded to fit perfectly every time
- Antiballistic composite material, fiberglass and high-temp resins yield an exceptional guard; 8 times stronger, 2 times stiffer, yet 1,5 times lighter than aluminum
- The level of heat reached by 4-strokes causes pipes to ding easily; it can also burn your pants and leg; end the hassle by installing a Moose Racing pipe guard
- Our pipe guards distribute impacts over a large area; aluminum guards cannot duplicate this effect
- See pages 42-44 of the 2024 Parts Europe Offroad catalog for Moose Racing's full line of pipe guards by Eline

FOR 4-STROKE EXHAUST

FITS MODEL	STOCK PART #	FITS MODEL	STOCK PART #	FITS MODEL	STOCK PART #
BETA		HUSQVARNA		KTM (CONT)	
RR/RS 4T 350/430/480/500 23-25	1861-1744	FC 250 24-25 (heat shield stock pipe)	1861-1730	SX-F 350 23-24 (heat shield stock pipe)	1861-1729
GASGAS		FC 350 23-24 (heat shield stock pipe)	1861-1729	EXC-F 350 23-24	1861-1729
MC 250F 24	1861-1730	FE 350 24-25	1861-1788	EXC-F 350 25	1861-1788
MC 350F 24-25	1861-1729	FE 501 24-25	1861-1788	EXC-F 450 24-25	1861-1789
EC 350F 24-25	1861-1788	KTM			
EC 500F 24-25	1861-1788	SX-F 250 23-24 (heat shield stock pipe)	1861-1730		

FOR 2-STROKE EXHAUST

FITS MODEL	STOCK EXHAUST PART #	FMF FATTY PART #	FMF FACTORY PART #	FMF GNARLY PART #	PRO CIRCUIT EXHAUST (ALL STYLES) PART #
GASGAS					
MC 125 24-25	1861-1731	1861-1740	-	-	-
EC 250/300 24-25	-	1861-1741	1861-1741	1861-1741	1861-1742
HUSQVARNA					
TC 125 23-25	1861-1731	1861-1740	-	-	-
TC 250 24	-	1861-1741	1861-1741	1861-1741	1861-1742
TE 150 24-25	1861-1731	-	-	-	-
TE 250/300 24-25	-	1861-1741	1861-1741	1861-1741	1861-1742
KTM					
SX 125 23-25	1861-1731	1861-1740	-	-	-
SX 250/300 23-25	-	1861-1741	1861-1741	1861-1741	1861-1742
EXC 150 24-25	1861-1743	-	-	-	-
EXC 250/300 24-25	-	1861-1741	1861-1741	1861-1741	1861-1742

DISCLAIMER: SEE PAGE 4 FOR IMPORTANT INFORMATION REGARDING CERTAIN WARRANTY AND EMISSION CONTROL REGULATION COMPLIANCE AND NOISE REGULATION INFORMATION.



1510-1187



1510-1186



1510-1190

EXHAUST

LUGGAGE

BIKE STANDS & ACCESSORIES

HANDLEBARS & HAND CONTROLS

FOOTPEGS & FOOT CONTROLS

BODY

GRAPHICS & SEATS

SPROCKETS

CHAINS

BRAKES

WHEELS & ACCESSORIES

SUSPENSION

ELECTRICAL & GAUGES

LIGHTING

ENGINE

FUEL/AIR SYSTEMS

HARDWARE & MERCHANDISING

ADVENTURE BIKE REAR RACKS

- Add convenient storage and function to your Adventure bike with one of these durable rear racks
- Laser-cut from 12-gauge grade 50 steel with durable matte black powdercoat finish

- Multiple tie-down locations and slots for bag straps or bungees
- Add additional storage capability with optional Universal Attachment Plates (sold separately)
- All mounting hardware and instruction included

ADVENTURE BIKE REAR RACK FITMENT CHART

FITS MODEL	PART #	FITS MODEL	PART #	FITS MODEL	PART #
APRILIA		KAWASAKI		SUZUKI	
Tuareg 660 22-23	1510-1187	KLR650 22-24	1510-1239	DR-Z400S 00-23	1510-1199
HONDA		KTM		DR650S 96-23	1510-1188
CRF450L/RL 19-24	1510-1197	790/890 Adventure 20-22	1510-1237	YAMAHA	
XR650L 93-24	1510-1211	950/990 Adventure 20-22	1510-1198	Tenere 700 21-24	1510-1186

ADVENTURE BIKE REAR RACK UNIVERSAL MOUNTING PLATES

- Use in conjunction with Adventure Bike Rear Racks (sold separately), these mounting plates increase overall rack surface area for a variety of basic plastic storage cases or larger soft luggage bags to be securely installed
- Easily attaches to Rear Rack with predrilled holes and locking tabs in several locations to mount more forward or back on the rear rack surface

- Available in two sizes – small: 15 cm x 20,5 cm (6" x 8") and large 20,5 cm x 35,5 cm (8" x 14")
- Attaches by locking in the tabs to rear rack and tightens down with a hand knob included in kit
- All mounting hardware and installation instructions included along with a threaded hand knob to install any variety of hard cases with center thread inserts

ADVENTURE BIKE REAR RACK UNIVERSAL MOUNTING PLATES

DESCRIPTION	PART #	DESCRIPTION	PART #
Small: 15 cm x 20,5 cm (6" x 8")	1510-1190	Bag Carrier: 38 cm L x 32 cm W (15" x 12,5")	1510-1189
Large: 20,5 cm x 35,5 cm (8" x 14")	1510-1191		

ADV1 REAR RACK BAG

- Expandable zipper provides additional storage
- Universal mounting with quick-release buckles
- Reinforced top and bottom
- Multiple interior organization pockets
- External shock cord for additional storage
- Waterproof removable rain cover included
- Dimensions: 30,5 cm L x 33 cm W x 18 cm H; 30,5 cm L x 33 cm W x 25,4 cm H expanded (12" x 13" x 7"; 12" x 13" x 10" expanded)
- Volume: 15 L; 20 L expanded

DESCRIPTION

ADV1 rear rack bag

PART #

3515-0225





EXHAUST

LUGGAGE

BIKE STANDS & ACCESSORIES

HANDLEBARS & HAND CONTROLS

FOOTPEGS & FOOT CONTROLS

BODY

GRAPHICS & SEATS

SPROCKETS

CHAINS

BRAKES

WHEELS & ACCESSORIES

SUSPENSION

ELECTRICAL & GAUGES

LIGHTING

ENGINE

FUEL/AIR SYSTEMS

HARDWARE & MERCHANDISING



ADV1 CENTER REAR RACK BAG

- Constructed of durable waterproof tarpaulin
- Fully seam-sealed and waterproof
- Roll top for easy access
- Webbing attachment system for universal mounting
- Dimensions: 59,7cm L x 24,9 cm W x 24,9 cm H (23,5" x 9,8" x 9,8")
- 22 L capacity

DESCRIPTION	PART #
ADV1 center rear rack bag	3530-0034

ADV1 RACKLESS SADDLEBAGS

- Constructed of water-resistant tarpaulin
- Abrasion-resistant Hypalon panels for additional durability
- Universal mounting; multiple attachment angles for a custom fit
- Molle attachment system for accessories and seamless integration of Moose ADV1 Center Rear Bag
- Water-resistant zippers
- Vibration-absorbing protective pads under saddle
- Bag dimensions: 49 cm L x 28 cm W x 16 cm H (19,3" x 11" x 6")
- 18 L capacity per bag, 36 L total volume
- Sold in pairs

DESCRIPTION	PART #
ADV1 rackless saddlebags	3501-1915

ADV1 TANK BAG

- Constructed of water-resistant tarpaulin
- Expandable zipper provides additional storage
- Universal mounting with a quick-release design
- Water-resistant zippers feature glove-friendly zipper pulls
- Cable pass-through
- Three exterior pockets including clear map pocket
- Interior mesh pocket
- Molle attachment system for accessories
- Dimensions: 28,45 cm L x 21,5 cm W x 15 cm H; 28,45 cm L x 21,5 cm W x 20,3 cm H expanded (11,2" x 8,5" x 6"; 11,2" x 8,5" x 8" expanded)
- Volume: 9 L; 11 L expanded



DESCRIPTION	PART #
ADV1 tank bag	3502-0543



EXFIL-0 2.0 TOOL ROLL

- Built to hold all the on-the-road essentials and still fit into Biltwell's Exfil-7 bag (Black PART #3516-0195 and Green PART #3516-0217)
- Zippered pouch holds small loose stuff that most tool rolls don't accommodate
- Includes seven deep elastic socket holders and five angled wrench pockets
- Pockets engineered from more durable rip-stop fabric
- Two wider slots for pliers/wire cutters
- Bundles together with expandable G-hook-and-loop closure system
- Made from 600D abrasion-resistant polyester outer shell with high-viz orange interior lining

- Dimensions: 23,5 cm W x 18 cm tall when folded (9 1/4" x 7"); 47 cm W (18 1/2") when opened flat
- NOTE: Tools not included.**

DESCRIPTION	PART #
EXFIL-0 2.0 tool roll	3510-0179

EXHAUST

LUGGAGE

BIKE STANDS & ACCESSORIES

HANDLEBARS & HAND CONTROLS

FOOTPEGS & FOOT CONTROLS

BODY

GRAPHICS & SEATS

SPROCKETS

CHAINS

BRAKES

WHEELS & ACCESSORIES

SUSPENSION

ELECTRICAL & GAUGES

LIGHTING

ENGINE

FUEL/AIR SYSTEMS

HARDWARE & MERCHANDISING



TRIPOD STAND

- Helps reduce pressure on the front forks during transport
- Includes 10 mm and 14 mm base; can fit most models
- Easy to position between the front wheel and front mudguard
- Durable plastic construction



DESCRIPTION
Tripod stand

PART #
4101-0585



REPLACEMENT TOP RUBBER FOR PRO MR-1 BIKE STAND

- Comes with 2 injection molded rubber pads to replace worn out tops
- 6 large head aluminum rivets supplied with kit
- Made of oil & gas resistant rubber



DESCRIPTION

Replacement top rubber for Pro MR-1 bike stand

PART #

4101-0586



MOTO STARTING BLOCK

- Get the best start ever with Factory Links starting block
- Anti-slip top plate
- Carrying handle
- Developed with MXGP riders
- Made from 2.5 mm thick aluminum
- Measures 20 cm L x 12 cm W x 10 cm H (7,87" x 4,72" x 3,94"); weighs 480 g (1.1lb.)



DESCRIPTION

Moto starting block

PART #

4101-0579



PIT MAT

- Designed to not only dress up your pit area but are also environmentally friendly
- The bike mat absorbs up to 6 L of fluid like radiator coolant along with other solvent-based products that can harm the environment by containing within the mat
- Not only lightweight but can be easily washed and reused
- Measures: 80 cm x 200 cm (31 1/2" W x 78 3/4")



DESCRIPTION

Pit mat

PART #

9905-0231



EXHAUST

LUGGAGE

BIKE STANDS & ACCESSORIES

HANDLEBARS & HAND CONTROLS

FOOTPEGS & FOOT CONTROLS

BODY

GRAPHICS & SEATS

SPROCKETS

CHAINS

BRAKES

WHEELS & ACCESSORIES

SUSPENSION

ELECTRICAL & GAUGES

LIGHTING

ENGINE

FUEL/AIR SYSTEMS

HARDWARE & MERCHANDISING



9905-0232



9905-0239



9905-0238

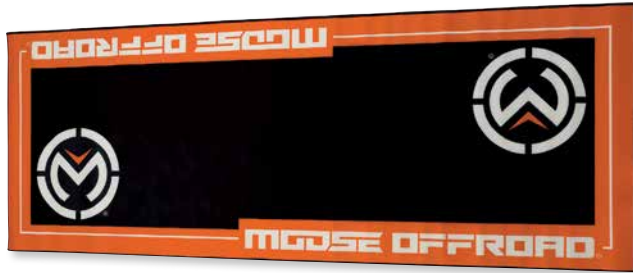

9905-0241

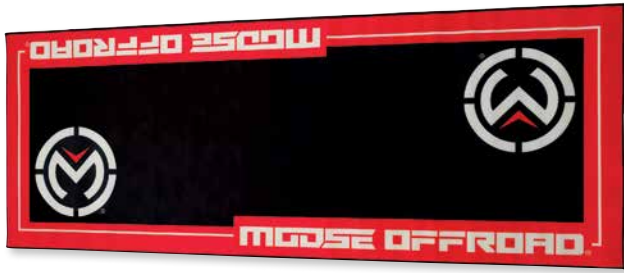

9905-0237



9905-0240

MOOSE OFFROAD BIKE MATS

- Protects the ground and environment
- Absorbs oil, water, dust
- Easy to clean, rubbery bottom and anti-slip

- Comes in a variety of colors
- Meets FIM environmental rules
- Measures: 80 cm W x 200 cm L (31 1/2" x 78 3/4")

DESCRIPTION	MOOSE OFFROAD 2025 PART #
ATV	9905-0232 ¹
Blue	9905-0239
Green	9905-0238
Orange	9905-0241

DESCRIPTION	MOOSE OFFROAD 2025 PART #
Red	9905-0237
Yellow/blue	9905-0240

¹ 63" W x 83 3/4" L.

MOOSE OFFROAD WORK BENCH MAT

- Designed to dress up your work bench but also aide in absorbing any fluids that may leak from your motor or whatever you may be working on the bench and are environmentally friendly
- Absorbs 1 L of oil, contact cleaner, anti-freeze, or other fluids that may spill onto the work bench area
- Helps add in keeping work area organized and looking professional without the issues of having to clean up after every spill
- Can be cleaned with mild soap and water and reused
- Saves on cleaning supplies and cleaners and reduces clean up time in the work area
- Measures: 53,5 cm W x 76 cm L (21" x 30")



DESCRIPTION	PART #
Moose Offroad work bench mat	9905-0233



EXHAUST

LUGGAGE

BIKE STANDS & ACCESSORIES

HANDLEBARS & HAND CONTROLS

FOOTPEGS & FOOT CONTROLS

BODY

GRAPHICS & SEATS

SPROCKETS

CHAINS

BRAKES

WHEELS & ACCESSORIES

SUSPENSION

ELECTRICAL & GAUGES

LIGHTING

ENGINE

FUEL/AIR SYSTEMS

HARDWARE & MERCHANDISING

FATBAR™ PURPLE HANDLEBARS

- 7010-T6 aluminum alloy, braceless design to reduce weight while maintaining an extremely high strength
- The braceless design allows for a comfortable level of flexibility
- 28,6 mm (1 1/8") clamping area reduces slippage
- Laser-etched positioning grid; knurled clutch side bar end prevents grip slippage
- Shot-peened, anodized finish resists corrosion
- Each handlebar includes an updated injection-molded foam bar pad for better protection and greater durability
- Require 28,6 mm (1 1/8") bar mounts for bikes originally equipped with 22 mm (7/8") bars

Handlebar Dimensions

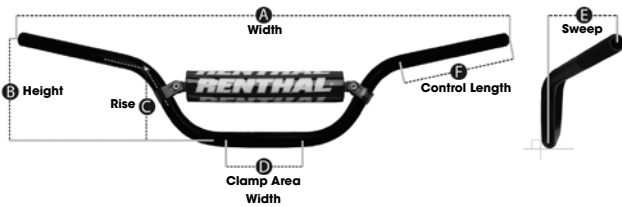

- Purple line is a limited edition color; other colors also available (see bullet below)
- See page 107 of the 2024 Parts Europe Offroad catalog for the full line of Renthal® Fatbar™ Handlebars

BEND	RENTHAL BEND #	A - WIDTH (MM)	B - HEIGHT (MM)	C - RISE (MM)	D - BASE (MM)	E - SWEEP (MM)	F - CONTROL LENGTH (MM)	PART #
RC	604	802	99	65	200	54	188	0601-6430
RC High	609	802	119	80	200	54	190	0601-6431
McGrath/KTM SX 125-450 16-21/Suzuki 18-21	821	813	78	42	150	54	200	0601-6432
Villopoto/Stewart	827	811	92	52	117	52	222	0601-6433
Honda CRF 19	839	802	91	52	131	51	200	0601-6434



0601-6426



0601-6425



0601-6424



0601-6423

TWINWALL® PURPLE HANDLEBARS

- Constructed of two aluminum alloy tubes, one inside the other
- Outer tube is 7010-T73, has extreme resistance to mechanical damage and is anodized to prevent corrosion
- Inner tube is ultra-high strength 7010-T6 aluminum, hard anodized to resist wear from twist grip and controls
- Rubber seals are used to cover the ends of the outer tube to keep water and cleaning fluids out
- Laser-marked in the middle for accurate positioning
- Available with anodized finish in your favorite racer's bend
- Each handlebar includes an updated injection-molded foam bar pad for better protection and greater durability
- Require 28,6 mm (1 1/8") bar mounts for bikes originally equipped with 22 mm (7/8") bars

Handlebar Dimensions

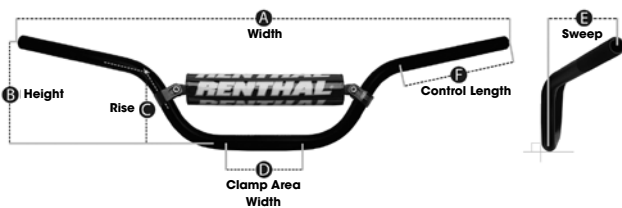

- Purple line is a limited edition color; other colors available (see bullet below)
- See page 108 of the 2024 Parts Europe Offroad catalog for the full line of Renthal® Twinwall® Handlebars

BEND	RENTHAL BEND #	A - WIDTH (MM)	B - HEIGHT (MM)	C - RISE (MM)	D - BASE (MM)	E - SWEEP (MM)	F - CONTROL LENGTH (MM)	PART #
McGrath/Short	999	805	83	40	205	55	200	0601-6426
Reed/Windham	998	803	92	56	210	57	190	0601-6425
RC/Honda CRF 04-18/Kawasaki KX/KX-F 06+	997	802	99	65	200	54	170	0601-6424
Villopoto/Stewart/Honda CRF 19+	996	805	93	50	205	55	200	0601-6423

HANDLEBARS & HAND CONTROLS



EXHAUST

LUGGAGE

BIKE STANDS & ACCESSORIES

HANDLEBARS & HAND CONTROLS

FOOTPEGS & FOOT CONTROLS

BODY

GRAPHICS & SEATS

SPROCKETS

CHAINS

BRAKES

WHEELS & ACCESSORIES

SUSPENSION

ELECTRICAL & GAUGES

LIGHTING

ENGINE

FUEL/AIR SYSTEMS

HARDWARE & MERCHANDISING



Handlebar Dimensions

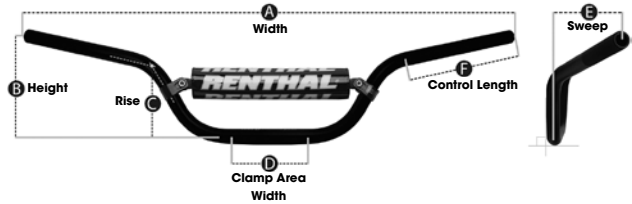

22 MM (7/8") PURPLE OFFROAD HANDLEBARS

- Exclusive aerospace aluminum alloy is precisely engineered for the best combination of strength and fatigue reduction
- Shot-peened finish for improved fatigue life
- Laser-marked positioning grid
- Exclusive, copyrighted lightweight clamping system for the cross brace; bolted and bonded to increase strength
- Special edition racer bars are dual-anodized in silver with colored ends

- Each handlebar includes an updated injection-molded foam bar pad for better protection and greater durability
- Purple line is a limited edition color; other colors available (see bullet below)
- See page 109 of the 2024 Parts Europe catalog for the full line of Renthal® 22 mm Offroad Handlebars

7/8" HANDLEBARS

BEND	A - WIDTH (MM)	B - HEIGHT (MM)	C - RISE (MM)	D - CLAMP WIDTH AREA (MM)	COLOR	PART #	E - SWEEP (MM)	F - CONTROL LENGTH (MM)
MOTOCROSS/ENDURO								
Reed/Windham	807	88	61	135	Purple	0601-6428	60	203
RC	802	97	62	135	Purple	0601-6429	53	201
RC High	814	119	84	120	Purple	0601-6427	56	197



22 MM (7/8") HANDLEBARS

- 22 mm (7/8") OD x 3 mm (0.12") wall seamless 4130 chromoly tubing
- All bends are created with internal mandrels on a CNC bender to reduce flat spots in the bends
- All welded joints are precision-mitered and TIG-welded

NOTE: Tracker bars are slightly wider than stock bars, so make sure to consider turning angle and tank size/mounting before ordering.

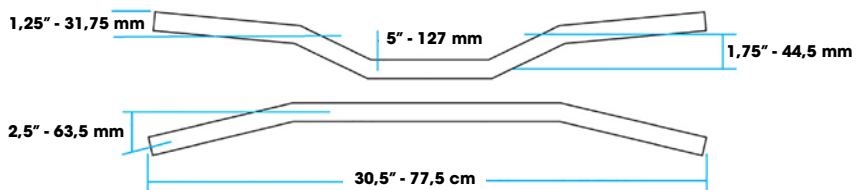

DESCRIPTION	END RISE	CENTER WIDTH	WIDTH	PULLBACK	BLACK PART #	CHROME PART #
Tracker Mid	8.25 cm (3.25")	12.7 cm (5")	77.5 cm (30.5")	7 cm (2.75")	0601-4097	-
Tracker High	11.4 cm (4.5")	12.7 cm (5")	76.2 cm (30")	6.4 cm (2.5")	0601-4095	0601-4096

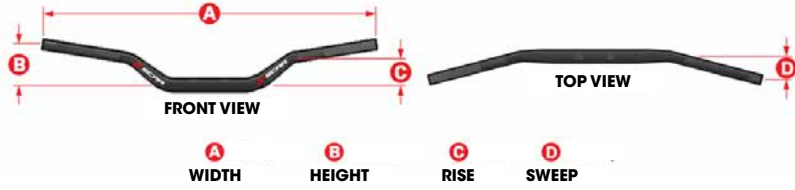

X² HANDLEBARS

- Polished and anodized aluminum provides durability and scratch-resistance
- Includes a crossbar with bar pad
- 22 mm ($7/8$ ") diameter at control ends and 28,6 mm ($1\ 1/8$ ") clamping diameter
- Marked for better indexation and centering of handlebar

- For off-road bikes with 28,6 mm ($1\ 1/8$ ") clamps
- See page 111 of the 2024 Parts Europe Offroad catalog for the complete line of SCAR X² handlebars

STYLE	WIDTH-A (MM)	HEIGHT-B (MM)	RISE-C (MM)	SWEEP-D (MM)	COLOR	PART #
Reed	803	98	69	56	Black w/ black pad	0601-6803

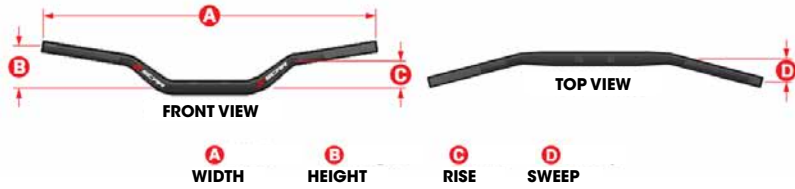

O² HANDLEBARS

- Polished and anodized aluminum provides durability and scratch resistance
- 22 mm ($7/8$ ") diameter at control ends and 28,6 mm ($1\ 1/8$ ") clamping diameter
- Marked for better indexation and centering of handlebar
- For off-road bikes with 28,6 mm ($1\ 1/8$ ") clamps
- Includes bar pad; additional bar pads available separately, see page 24

- See page 110 of the 2024 Parts Europe Offroad catalog for the complete line of SCAR O² handlebars

FITS MODEL	WIDTH-A (MM)	HEIGHT-B (MM)	RISE-C (MM)	SWEEP-D (MM)	COLOR	PART #
CRF 18-24, KX 21-24	800	93	54	49	Black	0601-6451



S² HANDLEBARS

- Polished and anodized aluminum provides durability and scratch resistance
- Marked for better indexation and centering of handlebar
- For off-road bikes with 22 mm ($7/8$ ") clamps

- Include bar pad; additional bar pads available separately, see page 24
- See page 111 of the 2024 Parts Europe catalog for the complete line of SCAR S² handlebars

TYPE	WIDTH-A (MM)	HEIGHT-B (MM)	SWEEP-C (MM)	COLOR	PART #
Pit Bike	724	171	44	Black	0601-6452

EXHAUST

LUGGAGE

BIKE STANDS & ACCESSORIES

HANDLEBARS & HAND CONTROLS

FOOTPEGS & FOOT CONTROLS

BODY

GRAPHICS & SEATS

SPROCKETS

CHAINS

BRAKES

WHEELS & ACCESSORIES

SUSPENSION

ELECTRICAL & GAUGES

LIGHTING

ENGINE

FUEL/AIR SYSTEMS

HARDWARE & MERCHANDISING

EXHAUST

LUGGAGE

BIKE STANDS & ACCESSORIES

HANDLEBARS & HAND CONTROLS

FOOTPEGS & FOOT CONTROLS

BODY

GRAPHICS & SEATS

SPROCKETS

CHAINS

BRAKES

WHEELS & ACCESSORIES

SUSPENSION

ELECTRICAL & GAUGES

LIGHTING

ENGINE

FUEL/AIR SYSTEMS

HARDWARE & MERCHANDISING



FATBAR™ PURPLE PADS

- For use with Fatbar™ handlebars
- High-density, injection-molded foam offers more protection
- Durable TPU cover with hook-and-loop fastener
- Power washer-proof permanent graphics
- Dimension: 25,5 cm L x 89 mm W x 70 mm H (10" x 3 1/2" x 2 3/4")
- Purple line is a limited edition color; other colors available (see bullet below)
- See page 119 of the 2024 Parts Europe Offroad catalog for the full line of Renthal® Fatbar™ pads



COLOR	PART #
Purple	0601-5721



SX CROSSBAR PAD

- Features injection-molded foam for better impact protection and significant increase in lifespan
- Improved fit on the crossbase which helps decrease movement during use
- Fits 22 mm (7/8") handlebars
- Sold each
- See page 120 of the 2024 Parts Europe Offroad catalog for the full line of Renthal® SX Crossbar Pads



CROSSBAR PADS

COLOR	PART #
Purple	0601-5720



0601-6683



0601-6684

FLIGHT MX BAR MOUNT PAD AND OVERSIZED CROSSBAR PAD

- ODI Bar pads are formed from a high-density, extruded foam tube that is capped off with a protected end made of ODI grip rubber that is color-matched to popular grip colors
- Designed to fit most motocross and offroad type handlebars

- Bar pad dimensions: 185 mm L x 85 mm W x 58 mm H
- Crossbar pad measures: 245 mm L x 50 mm D
- Available in blackout color

DESCRIPTION	PART #	DESCRIPTION	PART #
Flight MX bar mount pad	0601-6683	SX8 oversized crossbar pad	0601-6684



PIT BIKE BAR PAD

- Designed for pit and mini bikes
- Provides added protection for the rider
- High-quality construction
- 210 mm L
- Available in black
- See page 121 of the 2024 Parts Europe Offroad catalog for the complete line of SCAR bar pads



DESCRIPTION	PART #
Pit bike bar pad	0603-1139



EXHAUST

LUGGAGE

BIKE STANDS & ACCESSORIES

HANDLEBARS & HAND CONTROLS

FOOTPEGS & FOOT CONTROLS

BODY

GRAPHICS & SEATS

SPROCKETS

CHAINS

BRAKES

WHEELS & ACCESSORIES

SUSPENSION

ELECTRICAL & GAUGES

LIGHTING

ENGINE

FUEL/AIR SYSTEMS

HARDWARE & MERCHANDISING

APEX TRIPLE CLAMPS

- Manufactured from 7075-T6 aerospace-quality aluminum
- Designed to minimize distortion in the clamping area, enhancing responsiveness
- Split clamp design with self-locking mechanism offers greater protection against fork twisting
- Clamping screws function independently, enabling more precise control over the clamping torque
- Top clamp offers 6 different handlebar mount positions: 3 on the clamp, as well as reversible bar mounts which allow fore and aft positioning
- M12 bolts threaded directly into the top triple clamp with wide groove to locate the bar mount
- Supplied with steering stem and pressed steering bearing
- Perfect flexibility adapted precisely to OEM forks
- Optimally tuned steering stem stiffness
- Eye-catching silver finish

TRIPLE CLAMPS

FITS MODEL	PART #
GASGAS	
MC 65 21-23	0603-1153
MC 65 24-25	0603-1154
MC 85 21-24	0603-1156
MC 85 25	0603-1157
MC 125/250/250F/350F/450F 24-25, MC 150/300 25	0603-1155
HONDA	
CR 125/250R 97-07, CRF 250R 04-07, CRF 450R 02-04	0603-1150
CRF 250R 22-25, CRF 450R 21-25	0603-1151
HUSQVARNA	
TC 65 21-23	0603-1153
TC 65 24-25	0603-1154
TC 85 14-24	0603-1156
TC 85 25	0603-1157
TC 125/250 23-25, TC 150/300 25, FC 250/350/450 23-25	0603-1155
KAWASAKI	
KX 250F 06-18, KX 250 19-25, KX 450F 07-18, KX 450 19-25	0603-1152

APEX BAR MOUNT

- Allows for 24 positions of handlebar adjustability
- CNC-machined with black anodized finish
- Four height options included : 30, 35, 40, 45 mm
- Fits 28,6 mm (1 1/8") clamping area
- Designed for SCAR APEX triple clamps only

FITS MODEL	PART #
KTM	
SX 65 21-23	0603-1153
SX 65 24-25	0603-1154
SX 85 04-24	0603-1156
SX 85 25	0603-1157
SX 125/250/300 23-25, SX 150 25, SX-F 250/350/450 23-25, EXC 125/250/300 24-25, EXC-F 250/350/450/500 24-25	0603-1155
YAMAHA	
YZ 125 15-25	0603-1148
YZ 250 15-25	0603-1149
YZ 250F 12-25, YZ 450F 10-25	0603-1147

BAR MOUNTS

DESCRIPTION	PART #
APEX triple clamp bar mounts	0603-1158



BAR MOUNTS FOR OEM TRIPLE CLAMPS

- Allows the use of OEM clamps with 28,6 mm (1 1/8") handlebars
- Can be used with stock rubber cones and/or Scar Rubber Killers (sold separately)
- See page 129 of the 2024 Parts Europe Offroad catalog for the complete line of SCAR bar mounts

FITS MODEL	PART #
HUSQVARNA	
TC/FC 23-25, TE/FE 24-25	0603-1137

FITS MODEL	PART #
KTM	
SX/SX-F 23-25, EXC/EXC-F 24-25	0603-1137

RUBBER KILLERS

- Sturdy way to replace the rubber in stock triple clamps
- Provide better control and prevent handlebars from twisting during a fall
- CNC-machined with anodized finish
- Sold in set of four
- See page 129 of the 2024 Parts Europe Offroad catalog for the complete line of SCAR Rubber Killers

FITS MODEL	COLOR	PART #
HUSQVARNA		
TC/FC 23-25, TE/FE 24-25	Black	0603-1136

FITS MODEL	COLOR	PART #
KTM		
SX/SX-F 23-25	Black	0603-1136



HANDLEBARS & HAND CONTROLS

EXHAUST

LUGGAGE

BIKE STANDS & ACCESSORIES

HANDLEBARS & HAND CONTROLS

FOOTPEGS & FOOT CONTROLS

BODY

GRAPHICS & SEATS

SPROCKETS

CHAINS

BRAKES

WHEELS & ACCESSORIES

SUSPENSION

ELECTRICAL & GAUGES

LIGHTING

ENGINE

FUEL/AIR SYSTEMS

HARDWARE & MERCHANDISING



0602-1507



HANDLEBAR RISER KITS

- Made from 6061-T6 billet aluminum
- Includes sizes 5 to 30 mm
- Includes all hardware and wrench
- See page 132 of the 2024 Parts Europe Offroad catalogue for additional handlebar riser kits

FITS MODEL	PART #	FITS MODEL	PART #
GASGAS		KTM	
125-500 24-25 (all w/ cast triple clamps)	0602-1518	EXC/EXC-F 125-500 25 (cast triple clamps)	0602-1518
HUSQVARNA		UNIVERSAL	
TE/FE 150-501 24-25 (cast triple clamps)	0602-1518	For use w/ 22 mm OD handlebars	0602-1507



0410-0473



STEERING STEM BEARING KITS

- Restore the original smooth steering response; no more notchy feeling
- Exact OEM replacement kit; highest quality materials used in seals, bearings and races

FITS MODEL	PART #	FITS MODEL	PART #	FITS MODEL	PART #
HONDA		HONDA (CONT)		HONDA (CONT)	
CRF 110F 19-24	0410-0473	CRF 125F 19-24	0410-0473	CRF 250F 19-24	0410-0473



STEERING STEM BEARING KITS

- Contains all elements required for a full OEM-quality service of your steering stem
- Dedicated tapered bearings and dust seals with an off-road design are specifically manufactured in order to reach the stringent OEM quality requirements, in terms of materials, dimension tolerances, hardness and surface roughness

• See pages 138-141 of the 2024 Parts Europe Offroad catalog for the complete line of Factory Links steering stem bearing kits

FITS MODEL	PART #	FITS MODEL	PART #
SHERCO		SHERCO (CONT)	
SE 125 Factory 25	0401-0117	SEF 300 Factory 25	0401-0117
SE 250 Factory 25	0401-0117	SEF 450 Factory 25	0401-0117
SE 300 Factory 25	0401-0117	SEF 500 Factory 25	0401-0117
SEF 250 Factory 25	0401-0117		



EXHAUST

LUGGAGE

BIKE STANDS & ACCESSORIES

HANDLEBARS & HAND CONTROLS

FOOTPEGS & FOOT CONTROLS

BODY

GRAPHICS & SEATS

SPROCKETS

CHAINS

BRAKES

WHEELS & ACCESSORIES

SUSPENSION

ELECTRICAL & GAUGES

LIGHTING

ENGINE

FUEL/AIR SYSTEMS

HARDWARE & MERCHANDISING

ALUMINUM OPEN-ENDED MOTO ROOST DEFLECTOR MOUNTING KIT

- Slim design leaves more room for controls
- Universal handlebar fit
- Fits ATVs, motorcycles, and snowmobiles
- Helps deflect roost away from your hands and controls
- Design offers open handlebar end
- All installation hardware is included
- Available in black; sold in a kit for 7/8" handlebars

DESCRIPTION

Aluminum open-ended moto roost deflector mounting kit

PART

0635-2622



0635-2450



0635-2456



0635-2453



0635-2457



0635-2451



0635-2452



0635-2454



0635-2455

MX-RACE HANDGUARDS

- Open handguards with universal mounting brackets
- Maximum protection from track/trail debris
- Dual-injection for increased impact resistance
- Flexible/lightweight/strong
- Two horizontal positions

- Built-in ventilation
- Bracket can mount above or below lever
- Universal fitment for all MX/enduro style 22 mm (7/8") handlebars
- Sold in pairs

COLOR	PART #	COLOR	PART #	COLOR	PART #	COLOR	PART #
Black/black	0635-2450	GasGas Red/black	0635-2453	Orange/black	0635-2451	White/black	0635-2454
Blue/black	0635-2456	Green/Black	0635-2457	Red/black	0635-2452	Yellow/black	0635-2455

HANDLEBARS & HAND CONTROLS



EXHAUST

LUGGAGE

BIKE STANDS & ACCESSORIES

HANDLEBARS & HAND CONTROLS

FOOTPEGS & FOOT CONTROLS

BODY

GRAPHICS & SEATS

SPROCKETS

CHAINS

BRAKES

WHEELS & ACCESSORIES

SUSPENSION

ELECTRICAL & GAUGES

LIGHTING

ENGINE

FUEL/AIR SYSTEMS

HARDWARE & MERCHANDISING



0635-2378



0635-2375



0635-2374



0635-2376



0635-2379

MX FLOW HANDGUARDS

- New and improved design to maximize protection
- Vented for extra air flow
- Available in most brand colors
- Specific bike mount or universal mounting kit included
- Sold in pairs
- See page 195 of the 2024 Parts Europe Offroad catalog for additional handguard applications

FITS MODEL	COLOR	PART #
BETA		
RR (all) 12-25	Gray/white	0635-2378
GASGAS		
MC 24-25, EC 21-25	Black/white	0635-2375
	White/black	0635-2374
MC/MC-F 21-23	Gray/white	0635-2379
EC/EC-F 21-25	White/red	0635-2376

FITS MODEL	COLOR	PART #
HUSQVARNA		
TC/FC/TE/FE 22-25	Gray/white	0635-2379
TE/FE 18-21	Black/white	0635-2382
	White/black	0635-2383
KTM		
SX 125 14-22, SX 150/250, SX-F/EXC/EXC-F (all) 14-25	Gray/white	0635-2379



0635-2365



0635-2367



0635-2368



0635-2366

BULLIT HANDGUARDS

- Lightweight and compact protection
- Black and white plastic cover included
- Vented for maximum airflow
- Adjusts horizontally in two positions

- Mounting kit included
- Solid in pairs
- See page 167 of the 2024 Parts Europe Offroad catalog for additional handguard applications

HANDGUARDS

FITS MODEL	COLOR	PART #
GASGAS		
MC/MC-F 24-25, EC/EC-F 250 21-25	Black	0635-2365
	Gray	0635-2367
	Red	0635-2368
	White	0635-2366

FITS MODEL	COLOR	PART #
HUSQVARNA		
TC 125 18-19, TE/FE (all) 18-21	Black	0635-2369
	White	0635-2370
TE/FE 125-501 22-25	Black	0635-2365
	White	0635-2366



EGO HANDGUARDS

- Designed for Enduro and trail bikes
- To fit tapered handlebar
- Two mounting points secure the full wraparound aluminum design
- Compact curved profile to protect hands and levers during intense trail and tight bush riding
- Heat treated aluminium backbone for maximum strength

COLOR	EGO HANDGUARDS	22 MM	PLASTIC GUARDS
Black	0635-2397	0635-2384	0635-2390
Black with black logo	0635-2410	0635-2406	0635-2408
Blue	0635-2398	0635-2385	0635-2391
Green	0635-2399	0635-2386	0635-2392
Hi-Viz	0635-2411	0635-2407	0635-2409

- Replaceable, high impact resistant EGO plastic guards included
- Large range of colours
- Deflectors available for increased protection
- Easy installation

Note: Not ideal for bikes with long clutch and brake levers.

COLOR	EGO HANDGUARDS	22 MM	PLASTIC GUARDS
Orange	0635-2400	-	0635-2393
Red	0635-2401	0635-2387	0635-2394
White	0635-2402	0635-2388	0635-2395
Yellow	0635-2403	0635-2389	0635-2396



EGO REPLACEMENT HANDGUARDS

- Ego plastic guards only
- To fit Ego aluminium backbone
- Designed for enduro and trail bikes
- Compact curved profile ideal for tight brush riding
- High impact resistant Ego plastic guards

DESCRIPTION	PART #
Black	0635-2462

- Proven to be one of the world's toughest and most durable handguards

NOTE: Plastic handguards only.

DESCRIPTION	PART #
White	0635-2463

MULTI-FIT CLAMP KIT

- Multi-Fit handlebar clamp kit to fit straight 22 mm handlebar
- Fits handlebars when cable clearance is required
- Easy installation
- Includes kit only (no backbone or plastic guards)



DESCRIPTION	PART #
For straight 22 mm handlebars	0635-2405

EXHAUST

LUGGAGE

BIKE STANDS & ACCESSORIES

HANDLEBARS & HAND CONTROLS

FOOTPEGS & FOOT CONTROLS

BODY

GRAPHICS & SEATS

SPROCKETS

CHAINS

BRAKES

WHEELS & ACCESSORIES

SUSPENSION

ELECTRICAL & GAUGES

LIGHTING

ENGINE

FUEL/AIR SYSTEMS

HARDWARE & MERCHANDISING

HANDLEBARS & HAND CONTROLS

EXHAUST

LUGGAGE

BIKE STANDS & ACCESSORIES

HANDLEBARS & HAND CONTROLS

FOOTPEGS & FOOT CONTROLS

BODY

GRAPHICS & SEATS

SPROCKETS

CHAINS

BRAKES

WHEELS & ACCESSORIES

SUSPENSION

ELECTRICAL & GAUGES

LIGHTING

ENGINE

FUEL/AIR SYSTEMS

HARDWARE & MERCHANDISING



MODEL 809 LOCK-ON GRIPS

- Half-waffle, dual-density design
- Include throttle tube and six different throttle cams for precise fitment
- Closed ends
- 115 mm L
- Sold in pairs

DESCRIPTION	PART #	DESCRIPTION	PART #	DESCRIPTION	PART #
(A) Black/black	0630-3240	(C) Gray/black	0630-3241	(E) Orange/black	0630-3242
(B) Black/red	0630-3243	(D) Gray/blue	0630-3244		



LOCK-ON GRIPS

- Revolutionary Lock-On grip system can be fitted to any aftermarket MX handlebar without modification
- Twin split collar clamp design allows for easy installation on knurled or non-knurled handlebars
- Slip-free fitment
- Includes throttle cam set utilized industry standard octagonal snap-fit design to enhance compatibility
- Tuff-End Tech end caps with Renthal® 'R' logos

- Simple Cam Alignment (SCA) feature ensures easy, precise, mistake-free logo and grip pattern alignment
- Comes in MX Original and MX R-Works patterns with choice of compound
- Sold in pairs



DESCRIPTION	PART #	DESCRIPTION	PART #
MX ORIGINAL		MX R-WORKS	
(F) Soft, Diamond	0630-3217	(K) Aramid, 1/2 waffle	0630-3222
(G) Soft, 1/2 waffle	0630-3219	(L) Aramid taper, 1/2 waffle	0630-3225
(H) Soft taper, 1/2 waffle	0630-3223	(M) Ultra-tacky™, 1/2 waffle	0630-3221
(I) Medium, Diamond	0630-3218	(N) Ultra-tacky™ taper, 1/2 waffle	0630-3224
(J) Medium, 1/2 waffle	0630-3220		



MOTO GRIPS

- Available for 22 mm (7/8") handlebars
- Choose either soft or medium firmness
- Textured gripping area for extra control
- Sold in pairs

DESCRIPTION	PART #	DESCRIPTION	PART #
(O) Soft	0630-3185	(P) Medium	0630-3186





MICRO-X HALF WAFFLE V2 LOCK-ON™ GRIPS

- Designed to fit micro-handlebars
- Slim diameter (28 mm to 29 mm inc. waffle) Diameter for your little Micro-X rippers
- Rugged knurl pattern on top of the grip for improved feedback and control
- Original MX Half-Waffle pattern for maximum traction at the fingertips
- Lock-On™ clutch side grip provides simple installation and removal
- Billet-alloy clamp delivers 100% Slip-Free Performance Guaranteed
- Includes billet-alloy adapters to also fit alternate brand handlebars

- Includes the following ODI throttle cams: E, L, N, P
- Sold in pairs

NOTE: Some models require the use of OEM throttle cam. E-models do not require a throttle cam for use.

DESCRIPTION	PART #	DESCRIPTION	PART #	DESCRIPTION	PART #
(A) Black/silver	0630-3291	(C) Graphite/silver	0630-3293	(E) Orange/black	0630-3294
(B) Blue/silver	0630-3296	(D) Gray/black	0630-3292	(F) Red/silver	0630-3295

V2 LOCK-ON GRIPS

- ODI has revamped its popular Lock-On MX Grip to make it even better
- The Lock-On Grip System allows you to change or replace grips in seconds without the need for any wire ties or glues
- Delivers slip-free performance under any conditions
- Simple installation and removal without waiting for glue to dry
- Throttle tube included with snap-on cam to match more models
- Knockout ends easily accommodate handguards
- Available in half-waffle

- Kit includes 4-stroke cams A, B, J and M, along with 2-stroke cams C and D
- See page 182 of the 2024 Parts Europe Offroad catalog for additional cams and applications
- Compatible with V2 throttle cams

DESCRIPTION	PART #
Purple	0630-3282

V2 THROTTLE CAM

SHERCO 125/250/300 SE FACTORY 21-24

- For use with the V2 Lock-On system and the ODI Fuzion throttle tube system
- Sold separately from the starter kit, these cams increase the available model options for customers wanting to use the ODI V2 Lock-On System
- Each cam sold separately



DESCRIPTION	CAM FITMENTS	PART #
Throttle Cam	S2	0632-0989

UNIVERSAL LOCK-ON™ GRIP SETS

- Fits any 7/8" style of handlebar with twist-throttle
- Clutch side Lock-On™ grip provides simple installation and removal with a billet-alloy clutch-side clamp that delivers easy installation and removal while providing slip-free performance
- Throttle side Slip-On grip fits onto any standard 7/8" model twist throttle tube.
- Designed to install with grip glue/rubbing alcohol and/or safety-wire
- Half-waffle grip pattern
- Diameter: 29.5/30.5 mm
- Medium compound material
- Length: 125 mm overall grip length
- Easy knockout grip-ends



DESCRIPTION	PART #	DESCRIPTION	PART #
(G) Black/silver	0630-3312	(I) Gray/silver	0630-3315
(H) Graphite/black	0630-3314	(J) White/black	0630-3316

EXHAUST

LUGGAGE

BIKE STANDS & ACCESSORIES

HANDLEBARS & HAND CONTROLS

FOOTPEGS & FOOT CONTROLS

BODY

GRAPHICS & SEATS

SPROCKETS

CHAINS

BRAKES

WHEELS & ACCESSORIES

SUSPENSION

ELECTRICAL & GAUGES

LIGHTING

ENGINE

FUEL/AIR SYSTEMS

HARDWARE & MERCHANDISING

HANDLEBARS & HAND CONTROLS

EXHAUST

LUGGAGE

BIKE STANDS & ACCESSORIES

HANDLEBARS & HAND CONTROLS

FOOTPEGS & FOOT CONTROLS

BODY

GRAPHICS & SEATS

SPROCKETS

CHAINS

BRAKES

WHEELS & ACCESSORIES

SUSPENSION

ELECTRICAL & GAUGES

LIGHTING

ENGINE

FUEL/AIR SYSTEMS

HARDWARE & MERCHANDISING



RUFFIAN MX SINGLE-PLY GRIPS

- ODI's proprietary medium-compound material provides comfort without sacrificing durability
- Used by top AMA motocross teams such as Motoconcepts, Yamaha and Troy Lee Designs racing
- Available in half-waffle
- For 22 mm (7/8") bars and use with twist throttles
- Sold in pairs

DESCRIPTION	PART #
Purple	0630-3318

TROY LEE DESIGNS MX GRIPS

- Designed by Troy Lee Designs
- Ergonomic designs conforms to a true riding position
- Reinforced ends provide extra protection and prevent grip blowout
- Stepped, raised diamond pattern provides slim feel with extra traction
- For 7/8" bars with twist throttle
- Sold in pairs

DESCRIPTION	PART #
Purple MX grips	0630-3317



MX HALF WAFFLE GRIP SET

- Classic black half-waffle Motocross grips suitable for all scooters, mopeds and motorcycles with 22 mm handlebar and throttle grip
- Outer length measures: 125 mm
- Inner length measures: 119 mm
- Throttle type: throttle twist grip
- Sold in pairs

DESCRIPTION	PART #	DESCRIPTION	PART #	DESCRIPTION	PART #
(A) Black	0630-3247	(B) Gray	0630-3248	(C) White	0630-3249



THROTTLE TUBES

- CNC-machined aluminum and PTFE coated on the inside for smooth throttle operation
- Stronger and more durable than OEM plastic units



FITS MODEL	PART #	FITS MODEL	PART #	FITS MODEL	PART #
GASGAS		HUSQVARNA		KTM	
MC 250F/450F 24-25	0632-1000	FC 250/450 23-25	0632-1000	SX-F 250/450 23-25	0632-1000



EZ3 CLUTCH LEVER ASSEMBLY

- Unique design allows up to 50% less effort to pull the clutch lever
- Choose from three positions according to your clutch pull and riding style
- Pivoting cable adjuster to position the angle of the cable to prevent wear
- Made from 100% aluminum alloy
- Red vulcanized silicone rubber grip for any riding condition
- Perch insert allows rotation upon impact
- Universal clutch fit
- Available with standard and "shorty" (25 mm (1") shorter than OEM) levers



- Hot start option available
- For off-road use only
- Replacement levers and parts available
- Replacement perch inserts available separately, PART #0615-0180 (3 pk.)
- See page 213 of the 2024 Parts Europe Offroad catalog for the complete line of EZ3 clutch lever assemblies

DESCRIPTION	GRIP COLOR	PART #
Shorty lever/perch assembly w/ hot start	Red	0612-0288



PIVOT CLUTCH LEVER ASSEMBLY

- Universal assembly for 2- and 4-stroke engines
- Aluminum flex levers prevent breakage in the event of a crash
- Easily adjustable reach system

DESCRIPTION	PART #
Pivot clutch assembly	0612-0514



RC8 REPLACEMENT FORGED LEVER

- Works with ARC RC8 clutch assemblies
- See page 211 of the 2024 Parts Europe Offroad catalog for the complete line of ARC RC8 clutch assemblies

DESCRIPTION	PART #
Repl. forged ARC flex lever (black)	0613-2047



0612-0377



0612-0393



MAGURA

167 HYMEC REPLACEMENT SLAVE SYSTEMS

- Works with Magura 167 Hymec black clutch systems
- See page 212 of the 2024 Parts Europe Offroad catalog for the complete line of Magura 167 Hymec black clutch systems

FITS MODEL	SLAVE PART #	FITS MODEL	SLAVE PART #
HONDA		KAWASAKI	
CRF 450R 13-14	0612-0377	KX 450F 15	0612-0393

EXHAUST

LUGGAGE

BIKE STANDS & ACCESSORIES

HANDLEBARS & HAND CONTROLS

FOOTPEGS & FOOT CONTROLS

BODY

GRAPHICS & SEATS

SPROCKETS

CHAINS

BRAKES

WHEELS & ACCESSORIES

SUSPENSION

ELECTRICAL & GAUGES

LIGHTING

ENGINE

FUEL/AIR SYSTEMS

HARDWARE & MERCHANDISING

HANDLEBARS & HAND CONTROLS



EXHAUST

LUGGAGE

BIKE STANDS & ACCESSORIES

HANDLEBARS & HAND CONTROLS

FOOTPEGS & FOOT CONTROLS

BODY

GRAPHICS & SEATS

SPROCKETS

CHAINS

BRAKES

WHEELS & ACCESSORIES

SUSPENSION

ELECTRICAL & GAUGES

LIGHTING

ENGINE

FUEL/AIR SYSTEMS

HARDWARE & MERCHANDISING



0614-1827



0613-2041

FLEX LEVERS

- Made from forged 6061-T6 aluminum lever body for added durability
- Comes in silver finish
- Flexible and unbreakable design that folds backwards on impact
- Adjustable to customize lever to accommodate various hand sizes
- Lever head is also machined from 6061-T6 aluminum
- Compatible with OE or Moose perches

FITS MODEL	BRAKE PART #	CLUTCH PART #	FITS MODEL	BRAKE PART #	CLUTCH PART #
BETA			HUSQVARNA (CONT)		
RR 125 18-25	0614-1827	0613-2041	TE 250/300 Brembo 14-16	0614-1829	0613-2041
RR 200 19-23	0614-1827	0613-2041	TE 250/300 Brembo 17-18	0614-1829	-
RR 250 13-25	0614-1827	0613-2041	TE 250/300 Braktec 22-25	0614-1830	-
RR 300 13-25	0614-1827	0613-2041	FE 250/350/450/501 Brembo 14-16	0614-1829	0613-2041
RR 350 11-25	0614-1827	0613-2041	FE 250/350/450/501 Brembo 17-21	0614-1829	-
RR 390/430/480 15-25	0614-1827	0613-2041	FE 250/350/450/501 Braktec 22-25	0614-1830	-
RR 400/450/498 12-14	0614-1827	0613-2041	KTM		
RR 500 17-19	0614-1827	0613-2041	SX 65/85 14-25	0614-1828	0613-2071
RR 520 10-11	0614-1827	-	SX 125/150 16-25	0614-1829	0613-2041
RR 525 06-09	0614-1827	-	SX-F 250 14-25	0614-1829	0613-2041
Xtrainer 250 19-25	0614-1827	-	SX-F 350 14-25	0614-1829	0613-2041
Xtrainer 300 15-25	0614-1827	-	SX-F 450 14-25	0614-1829	0613-2041
GASGAS			EXC 150 20-25	0614-1829	0613-2041
MC 65/85 21-25	0614-1828	0613-2071	EXC 250 18-25	0614-1829	0613-2041
MC 125/250 21-25	0614-1829	0613-2041	EXC 300 18-25	0614-1829	0613-2041
MC 250F/350F/450F 21-25	0614-1829	0613-2041	EXC 500 14-25	0614-1829	0613-2041
EC 125/300 00-17	-	0613-2076	EXC-F 250 14-25	0614-1829	0613-2041
EC 250/250F/300/350F 21-25	0614-1830	-	EXC-F 350 14-25	0614-1829	0613-2041
HONDA			EXC-F 450 14-25	0614-1829	0613-2041
CRF 150R 07-25	0614-1827	0613-2072	EXC-F 500 14-25	0614-1829	0613-2041
CRF 250R 10-25	0614-1832	0613-2073	Freeride 250F 18-19	0614-1828	0613-2071
CRF 250R L 17-25	0614-1860	0613-2074	Freeride 250R 14-19	0614-1828	0613-2071
CRF 300L 21	0614-1860	0613-2074	Freeride 350 14-19	0614-1828	0613-2071
CRF 450R 21-25	0614-1832	0613-2074	SHERCO		
CRF 450RWE 21-25	0614-1832	0613-2074	SER 125 17-25	0614-1829	0613-2041
CRF 450RX 21-25	0614-1832	0613-2075	SER 250/300 15-25	0614-1829	0613-2041
HUSQVARNA			SEF 250/300 15-25	0614-1829	0613-2041
TC 250 14-16	0614-1829	0613-2041	SEF 450 16-25	0614-1829	0613-2041
TC 250 17, 22-25	0614-1829	-	SEF 500 19-25	0614-1829	0613-2041
FC 250/350 14-15	0614-1829	0613-2041	YAMAHA		
FC 250/350 16-17	0614-1829	-	YZ 65 21-25	0614-1831	0613-2042
FC 250/350 22-25	0614-1829	-	YZ 125/250 15-25	0614-1831	0613-2042
FC 450 14-15	0614-1829	0613-2041	YZ 250F/450F 09-25	0614-1831	0613-2042
FC 450 16-17, 19-21	0614-1829	-	WR 250F 17-25	0614-1831	-
FC 450 22-25	0614-1829	0613-2041	WR 450F 16-25	0614-1831	-
TE 125 14-16	0614-1829	-			
TE 150 Brembo 17-18	0614-1829	-			
TE 150 Braktec 22-25	0614-1830	-			



FLEX LEVERS

- Adjustable for hand size and designed to flex during impact
- Shown are the pushrod style and ball bearing contact style for the brake lever
- Also supplied with the brake lever are a sleeve and bolt that almost eliminate up and down play
- Forged aluminum construction
- See page 231 of the 2024 Parts Europe Offroad catalog for the complete line of ARC Flex Levers

CLUTCH LEVERS

FITS MODEL	COLOR	STANDARD PART #	SHORTY PART #
GASGAS			
MC 65/85 21-25	Red	-	0613-2166
MC 125/250F/450F 21-25	Red	-	0613-2168
MC 125/150/250/250F/300/350/450F Braktec 24-25	Red	-	0613-2167
HONDA			
CRF 250R/RX/X 04-25	Red	0613-2139	-
CRF 450R/RX/RWE 04-20	Red	0613-2139	-
CRF 450R/RX/RWE 21-25	Red	0613-2140	-
CRF 450L/RL 19-25	Red	0613-2139	-
HUSQVARNA			
FX 350 Heritage Braktec 23	Black	0613-2134	-
KAWASAKI			
KX 65/80/85/100/112 05-25	Blue	0613-2150	-
	Composite	0613-2152	-
KX 250F (Nissin hydraulic) 21-25	Composite	0613-2157	-
KX 450F 19-25	Composite	0613-2157	-
KTM			
SX 125/150 Brembo 17-25	Orange	-	0613-2159
SX/SX-F/EXC/EXC-F 250 Brembo 06-25	Orange	-	0613-2159
SX 300 Brembo 23-25	Orange	-	0613-2159

BRAKE LEVERS

FITS MODEL	COLOR	PART #
GASGAS		
MC 125/250F/350F/450F Braktec 24-25	Red	0614-1970
	Composite	0614-1960
EC 250/250F/300/350F/450 Braktec 23-25	Red	0614-1970
	Composite	0614-1960
HONDA		
CR 80/85R 98-07	Red	0614-1955
CRF 125F 14-25	Red	0614-1955
CRF 150F/230F 03-09	Red	0614-1955
CRF 150R 07-21	Red	0614-1955
CRF 250F 19-25	Red	0614-1955
CRF 250R/450R 02-06	Red	0614-1955
CRF 250R/CRF250RX 07-25	Red	0614-1956
CRF 450R/S/RX/RWE 07-25	Red	0614-1956
HUSQVARNA		
TC 65 17-25	Blue	0614-1957
TC 85 13-25	Blue	0614-1957
TC 125/250 14-17, 19-25	Blue	0614-1958
FC 250/350/450 14-17, 19-25	Blue	0614-1958
TE/FE 150/250/300/350/450/501 13-17	Blue	0614-1958
TE/FE 150/250/300/350/450/501 Braktec 22-25	Composite	0614-1960
TE 300 Pro Braktec 24-25	Black	0614-1931
KAWASAKI		
KX 65/80/85/100/112 98-25	Blue	0614-1961
KX 125/250 02-07	Blue	0614-1961
KX 250F/450F 04-12	Blue	0614-1961
KX 250F 13-19	Blue	0614-1968
KX 250 20-25	Composite	0614-1963
KX 450F 13-18	Blue	0614-1968
KX 450 19-23	Composite	0614-1963
KX 450 24-25	Blue	0614-1958

FITS MODEL	COLOR	STANDARD PART #	SHORTY PART #
KTM (CONT)			
SX-F 350 11-25	Orange	-	0613-2159
SX-F 450 09-25	Orange	-	0613-2159
EXC 200 Brembo 14-16	Orange	-	0613-2159
EXC 300 Brembo 09-25	Orange	-	0613-2159
EXC/EXC-F 500 Brembo 12-25	Orange	-	0613-2159
Freeride 250-350 13-23	Orange	-	0613-2158
SUZUKI			
RM-Z 250 07-25	Blue	0613-2150	-
	Composite	0613-2152	-
RM-Z 450 05-25	Blue	0613-2150	-
	Composite	0613-2152	-
YAMAHA			
YZ 65/85 15-20	Composite	0613-2163	-
YZ 65/85 21-25	Blue	0613-2164	-
YZ 125/250 01-14	Blue	0613-2164	-
YZ 125/250 15-20	Composite	0613-2163	-
YZ 125/250 21-25	Blue	0613-2164	-
YZ 250F/450F GYTR Brembo hydraulic clutch	Blue	-	0613-2145

FITS MODEL	COLOR	PART #
KTM		
SX 65/85 14-25	Orange	0614-1964
SX 125 14-25	Orange	0614-1965
SX 150 14-25	Orange	0614-1965
SX/SX-F 250 14-25	Orange	0614-1965
SX-F/EXC-F 350 14-25	Orange	0614-1965
SX-F 450 14-25	Orange	0614-1965
EXC 500 14-25	Orange	0614-1965
SHERCO		
SE/SM/SM-R/SEF 125-450 17-25	Blue	0614-1958
SUZUKI		
RM 85 02-25	Blue	0614-1961
RM 100/125/250 96-09	Blue	0614-1961
RM-Z 250/450 05-25	Blue	0614-1961
RMX 450Z 17-19	Blue	0614-1961
TM		
All models 19-25	Composite	0614-1958
YAMAHA		
YZ 85 01-25	Blue	0614-1961
YZ 125/250 01-07	Blue	0614-1961
YZ 125/250 08-25	Blue	0614-1968
YZ 250F 01-06	Blue	0614-1961
YZ 250F 07-25	Blue	0614-1968
YZ 450F 01-07	Blue	0614-1961
YZ 450F 08-25	Blue	0614-1968
WR 250F/450F 16-25	Blue	0614-1968

EXHAUST

LUGGAGE

BIKE STANDS & ACCESSORIES

HANDLEBARS & HAND CONTROLS

FOOTPEGS & FOOT CONTROLS

BODY

GRAPHICS & SEATS

SPROCKETS

CHAINS

BRAKES

WHEELS & ACCESSORIES

SUSPENSION

ELECTRICAL & GAUGES

LIGHTING

ENGINE

FUEL/AIR SYSTEMS

HARDWARE & MERCHANDISING

HANDLEBARS & HAND CONTROLS



EXHAUST

LUGGAGE

BIKE STANDS & ACCESSORIES

HANDLEBARS & HAND CONTROLS

FOOTPEGS & FOOT CONTROLS

BODY

GRAPHICS & SEATS

SPROCKETS

CHAINS

BRAKES

WHEELS & ACCESSORIES

SUSPENSION

ELECTRICAL & GAUGES

LIGHTING

ENGINE

FUEL/AIR SYSTEMS

HARDWARE & MERCHANDISING



APT UNBREAKABLE LEVERS

- Proprietary compound that emulates the feel and touch of aluminum levers; hybrid structure with APT (Aero Parts Technology) manufacturing
- Durable and resistant to damage; levers can be restored to original shape after impacts
- Pivot system allows the lever to fold outward to prevent breakage
- Texturized lever surface with silk-printed logos

- Developed and tested with top pro riders and teams
- Mounts to stock perch and/or stock master cylinder
- Sold in pairs (one clutch and one brake lever) or each (one clutch or one brake lever)
- See page 235 of the 2024 Parts Europe Offroad catalog for additional lever applications

LEVER SETS

FITS MODEL	COLOR	PART #	FITS MODEL	COLOR	PART #
BETA			HUSQVARNA (CONT)		
RR 2T 125 18-24	Black	0614-1939	TE 125 14-16	Black	0614-1933
RR 2T 200 18-24	Black	0614-1939	TE 150 17	Black	0614-1933
RR 2T 250 15-24	Black	0614-1939	TE 150 22-25	Black	0614-1934
RR 2T 300 20-24	Black	0614-1939	TE 250 14-16	Black	0614-1933
RR 4T 350 13-24	Black	0614-1939	TE 250 22-25	Black	0614-1934
RR 4T 390 13-24	Black	0614-1939	TE 300 14-16	Black	0614-1933
RR 4T 430 15-24	Black	0614-1939	TE 300 25	Black	0614-1933
RR 4T 480 15-24	Black	0614-1939	FE 250 14-16	Black	0614-1933
RR X-Pro 2T 125 25	Black	0614-1939	FE 250 25	Black	0614-1933
RR X-Pro 2T 200 25	Black	0614-1939	FE 350 14-16	Black	0614-1933
RR X-Pro 2T 250 25	Black	0614-1939	FE 350 22-25	Black	0614-1934
RR X-Pro 2T 300 25	Black	0614-1939	FE 450 14-16	Black	0614-1933
RR X-Pro 4T 350 25	Black	0614-1939	FE 450 22-25	Black	0614-1934
RR X-Pro 4T 390 25	Black	0614-1939	KTM		
RR X-Pro 4T 430 25	Black	0614-1939	SX 125 14-25	Black	0614-1933
RR X-Pro 4T 480 25	Black	0614-1939	SX 250 14-25	Black	0614-1933
GASGAS			SX-F 250 14-25	Black	0614-1933
MC 125 21-23	Black	0614-1933	SX-F 350 14-25	Black	0614-1933
MC 125 24-25	Black	0614-1934	SX-F 450 14-25	Black	0614-1933
MC 250 21-23	Black	0614-1933	EXC 125 14-17	Black	0614-1933
MC 250 24-25	Black	0614-1934	EXC 200 14-25	Black	0614-1933
MC-F 250 21-23	Black	0614-1933	EXC 300 14-25	Black	0614-1933
MC-F 250 24-25	Black	0614-1934	EXC-F 250 14-25	Black	0614-1933
MC-F 350 21-23	Black	0614-1933	EXC-F 350 14-25	Black	0614-1933
MC-F 350 24-25	Black	0614-1934	EXC-F 450 14-25	Black	0614-1933
MC-F 450 21-23	Black	0614-1933	EXC-F 500 14-25	Black	0614-1933
MC-F 450 24-25	Black	0614-1934	SHERCO		
EC 250 21-25	Black	0614-1934	SE-R 125 18-25	Black	0614-1933
EC 300 21-25	Black	0614-1934	SE-R 250 15-25	Black	0614-1933
EC-F 350 21-25	Black	0614-1934	SE-R 300 15-25	Black	0614-1933
EC-F 450 21-25	Black	0614-1934	SEF-R 250 15-25	Black	0614-1933
HONDA			SEF-R 300 15-25	Black	0614-1933
CR 125 04-07	Black	0614-1935	SEF-R 450 15-25	Black	0614-1933
CR 250 04-07	Black	0614-1935	STARK		
CRF 250R 10-15	Black	0614-1936	VARG 23-25	Black	0614-1933
CRF 250RX 19-25	Black	0614-1936	TRIUMPH		
CRF 450R 07-20	Black	0614-1936	TF 250-X 24-25	Black	0614-1933
CRF 450R 21-25	Black	0614-1937	YAMAHA		
CRF 450RX 17-20	Black	0614-1936	YZ 125 09-25	Black	0614-1938
CRF 450RX 21-25	Black	0614-1937	YZ 125X 20-25	Black	0614-1938
HUSQVARNA			YZ 250 09-25	Black	0614-1938
TC 125 22-25	Black	0614-1933	YZ 250F 09-25	Black	0614-1938
TC 250 22-25	Black	0614-1933	YZ 250FX 20-25	Black	0614-1938
FC 250 22-25	Black	0614-1933	YZ 250X 18-25	Black	0614-1938
FC 350 22-25	Black	0614-1933	YZ 450F 09-25	Black	0614-1938
FC 450 22-25	Black	0614-1933	YZ 450FX 19-25	Black	0614-1938

APT UNBREAKABLE LEVERS (CONT)

CLUTCH LEVERS

FITS MODEL	PART #
BETA	
RR 2T 125 18-24	0614-1941
RR 2T 200 18-24	0614-1941
RR 2T 250 15-24	0614-1941
RR 2T 300 20-24	0614-1941
RR 4T 350 13-24	0614-1941
RR 4T 390 13-24	0614-1941
RR 4T 430 15-24	0614-1941
RR 4T 480 15-24	0614-1941
RR X-Pro 2T 125 25	0614-1941
RR X-Pro 2T 200 25	0614-1941
RR X-Pro 2T 250 25	0614-1941
RR X-Pro 2T 300 25	0614-1941
RR X-Pro 4T 350 25	0614-1941
RR X-Pro 4T 390 25	0614-1941
RR X-Pro 4T 430 25	0614-1941
RR X-Pro 4T 480 25	0614-1941
GASGAS	
MC 125 21-23	0614-1941
MC 125 24-25	0614-1942
MC 250 21-23	0614-1941
MC 250 24-25	0614-1942
MC-F 250 21-23	0614-1941
MC-F 250 24-25	0614-1942
MC-F 350 21-23	0614-1941
MC-F 350 24-25	0614-1942
MC-F 450 21-23	0614-1941
MC-F 450 24-25	0614-1942
EC 250 21-25	0614-1942
EC 300 21-25	0614-1942
EC-F 250 21-25	0614-1942
EC-F 350 21-25	0614-1942
EC-F 450 21-25	0614-1942
HONDA	
CR 125R 04-07	0614-1944

BRAKE LEVERS

FITS MODEL	PART #
BETA	
RR 2T 125 18-24	0614-1945
RR 2T 200 18-24	0614-1945
RR 2T 250 15-24	0614-1945
RR 2T 300 20-24	0614-1945
RR 4T 350 13-24	0614-1945
RR 4T 390 13-24	0614-1945
RR 4T 430 15-24	0614-1945
RR 4T 480 15-24	0614-1945
RR X-Pro 2T 125 25	0614-1945
RR X-Pro 2T 200 25	0614-1945
RR X-Pro 2T 250 25	0614-1945
RR X-Pro 2T 300 25	0614-1945
RR X-Pro 4T 350 25	0614-1945
RR X-Pro 4T 390 25	0614-1945
RR X-Pro 4T 430 25	0614-1945
RR X-Pro 4T 480 25	0614-1945
GASGAS	
MC 125 21-23	0614-1940
MC 125 24-25	0614-1943
MC 250 21-23	0614-1940
MC 250 24-25	0614-1943
MC-F 250 21-23	0614-1940
MC-F 250 24-25	0614-1943
MC-F 350 21-23	0614-1940
MC-F 350 24-25	0614-1943
MC-F 450 21-23	0614-1940
MC-F 450 24-25	0614-1943
EC 250 25	0614-1943
EC 300 25	0614-1943
EC-F 250 21-25	0614-1943
EC-F 350 21-25	0614-1943
EC-F 450 21-25	0614-1943
HONDA	
CR 125R 96-07	0614-1945
CR 250R 96-07	0614-1945
CRF 150R 08-23	0614-1945
CRF 150F 03-09	0614-1945
CRF 230F 03-19	0614-1945

FITS MODEL	PART #
HONDA (CONT)	
CR 250R 04-07	0614-1944
CRF 250R 10-25	0614-1944
CRF 250RX 19-25	0614-1944
CRF 450R 04-20	0614-1944
CRF 450R 21-25	0614-1946
CRF 450RX 21-25	0614-1946
HUSQVARNA	
TC 125 22-25	0614-1941
TC 250 22-25	0614-1941
FC 250 22-25	0614-1941
FC 350 22-25	0614-1941
FC 450 22-25	0614-1941
TE 125 14-17	0614-1941
TE 125 25	0614-1941
TE 150 22-24	0614-1942
TE 250 14-16	0614-1941
TE 250 21-24	0614-1942
TE 250 25	0614-1941
TE 300 14-16	0614-1941
TE 300 22-24	0614-1942
TE 300 25	0614-1941
FE 250 14-16	0614-1941
FE 250 22-24	0614-1942
FE 250 25	0614-1941
FE 350 14-16	0614-1941
FE 350 22-24	0614-1942
FE 350 25	0614-1941
FE 450 14-16	0614-1941
FE 450 22-24	0614-1942
FE 450 25	0614-1941
KTM	
SX 125 16-25	0614-1941
SX 250 09-25	0614-1941
SX-F 250 07-25	0614-1941

FITS MODEL	PART #
HONDA (CONT)	
CRF 250R 10-25	0614-1947
CRF 250RX 18-25	0614-1947
CRF 450R 07-25	0614-1947
CRF 450RX 17-25	0614-1947
XR 250R 96-04	0614-1945
XR 400R 96-04	0614-1945
XR 650R 03-07	0614-1945
HUSQVARNA	
TC 125 14-25	0614-1940
TC 250 14-25	0614-1940
FC 250 14-25	0614-1940
FC 350 14-25	0614-1940
FC 450 14-25	0614-1940
TE 125 14-17	0614-1940
TE 125 25	0614-1940
TE 150 22-24	0614-1943
TE 250 14-16	0614-1940
TE 250 22-24	0614-1943
TE 250 25	0614-1940
TE 300 14-17	0614-1940
TE 300 22-24	0614-1943
TE 350 25	0614-1940
TE 450 25	0614-1940
FE 250 14-17	0614-1940
FE 250 22-24	0614-1943
FE 350 14-17	0614-1940
FE 350 22-24	0614-1943
FE 450 14-17	0614-1940
FE 450 22-24	0614-1943
KAWASAKI	
KX 250F 15-20	0614-1949
KX 250 21-25	0614-1940
KX 250X 22-25	0614-1940
KX 450F 15-18	0614-1949
KX 450 19-25	0614-1940
KX 450X 24-25	0614-1940
KTM	
SX 125 14-25	0614-1940

FITS MODEL	PART #
KTM (CONT)	
SX-F 350 11-25	0614-1941
SX-F 450 07-25	0614-1941
EXC 125 08-17	0614-1941
EXC 200 08-25	0614-1941
EXC 300 08-25	0614-1941
EXC-F 250 07-25	0614-1941
EXC-F 350 12-25	0614-1941
EXC-F 450 07-25	0614-1941
EXC-F 500 12-25	0614-1941
SHERCO	
SE-R 125 18-25	0614-1941
SE-R 250 15-25	0614-1941
SE-R 300 15-25	0614-1941
SEF-R 250 15-25	0614-1941
SEF-R 300 15-25	0614-1941
SEF-R 450 15-25	0614-1941
STARK	
VARG 23-25	0614-1941
TRIUMPH	
TF 250-X 24-25	0614-1941
YAMAHA	
YZ 65 21-25	0614-1948
YZ 85 21-25	0614-1948
YZ 125 15-25	0614-1948
YZ 125X 18-25	0614-1948
YZ 250 15-25	0614-1948
YZ 250X 18-25	0614-1948
YZ 250F 09-25	0614-1948
YZ 250FX 20-25	0614-1948
YZ 450F 09-25	0614-1948
YZ 450FX 19-25	0614-1948
WR 450F 24-25	0614-1948

EXHAUST

LUGGAGE

BIKE STANDS & ACCESSORIES

HANDLEBARS & HAND CONTROLS

FOOTPEGS & FOOT CONTROLS

BODY

GRAPHICS & SEATS

SPROCKETS

CHAINS

BRAKES

WHEELS & ACCESSORIES

SUSPENSION

ELECTRICAL & GAUGES

LIGHTING

ENGINE

FUEL/AIR SYSTEMS

HARDWARE & MERCHANDISING

EXHAUST



LUGGAGE

CONTROL CABLES

- Clutch and throttle cable assemblies
- Black PVC outer jacket for maximum flexibility and durability
- Steel inner casing is tightly coiled for low compression ratios
- A pre-lubricated nylon inner sleeve guarantees smooth operation and long life
- All wire ends are bird-caged prior to terminal casting for superior pull-out resistance



0650-2085

BIKE STANDS & ACCESSORIES

HANDLEBARS & HAND CONTROLS

FOOTPEGS & FOOT CONTROLS

BODY

GRAPHICS & SEATS

SPROCKETS

CHAINS

BRAKES

WHEELS & ACCESSORIES

SUSPENSION

ELECTRICAL & GAUGES

LIGHTING

ENGINE

FUEL/AIR SYSTEMS

HARDWARE & MERCHANDISING

FITS MODEL	DESCRIPTION	PART #
GASGAS		
MC 125/250 24	Throttle (push/pull)	0650-2087
MC 250F/350F/450F 24-25	Throttle (push/pull)	0650-2085
EC 250/300 21-23	Throttle (push/pull)	0650-2084
EC 250/300 24	Throttle (push/pull)	0650-2087
EC 250F/350F/450F/500F 24-25	Throttle (push/pull)	0650-2085
FANTIC		
XX 125 22-24	Throttle (pull)	0650-2089
XXF 250 21-24	Clutch	0652-3105
	Throttle (push/pull)	0650-2088
XXF 450 22	Clutch	0652-3105
XE 125 23-24	Throttle (pull)	0650-2089
XEF 250 21-23	Clutch	0652-3105
	Throttle (push/pull)	0650-2088
XEF 250 24	Throttle (push/pull)	0650-2088
XEF 310 24	Throttle (push/pull)	0650-2088
XEF 450 22	Clutch	0652-3105
HONDA		
CRF 250R 22-24	Clutch	0652-3104
CRF 250RX 22-24	Clutch	0652-3104
HUSQVARNA		
TC 125 23-24	Throttle (push/pull)	0650-2087
TC 250 23-24	Throttle (push/pull)	0650-2087
FC 250/350/450 23-24	Throttle (push/pull)	0650-2085
TE 150/250/300 21-23	Throttle (push/pull)	0650-2084
TE 150 24	Throttle (push/pull)	0650-2087

- EPDM molded rubber components for high UV resistance and long life
- Injected-molded components are manufactured from high-strength POM material
- See pages 245-250 of the 224 Parts Europe Offroad catalog for Moose Racing's complete line of control cables

FITS MODEL	DESCRIPTION	PART #
HUSQVARNA (CONT)		
TE 300 24 (all)	Throttle (push/pull)	0650-2087
FE 250/350 24	Throttle (push/pull)	0650-2085
FE 450/501 24-25	Throttle (push/pull)	0650-2085
KTM		
SX 125 23-24	Throttle (push/pull)	0650-2087
SX 250 23-24	Throttle (push/pull)	0650-2087
SX-F 250 23-24	Throttle (push/pull)	0650-2085
SX-F 350/450 23	Throttle (push/pull)	0650-2085
EXC 150 24	Throttle (push/pull)	0650-2087
EXC 250 20-23	Throttle (push/pull)	0650-2084
EXC 250 24	Throttle (push/pull)	0650-2087
EXC 300 20-23	Throttle (push/pull)	0650-2084
EXC 300/Hardenduro 24	Throttle (push/pull)	0650-2087
EXC-F 250 24	Throttle (push/pull)	0650-2085
YAMAHA		
YZ 125 22-24	Throttle (pull)	0650-2089
YZ 125X 23-24	Throttle (pull)	0650-2089
YZ 250F 19-23	Clutch	0652-3105
	Throttle (push/pull)	0650-2088
YZ 250F 24	Throttle (push/pull)	0650-2088
YZ 250FX 20-24	Clutch	0652-3105
	Throttle (push/pull)	0650-2088
YZ 450F 18-23	Clutch	0652-3105
WR 250F 20-24	Throttle push/pull	0650-2088



FRONT BRAKE RESERVOIR AND CLUTCH RESERVOIR COVER

- Lightweight and durable replacement reservoir covers meet or exceed OEM specifications
- Anodized black finish
- See page 268 of the 2024 Parts Europe Offroad catalog for the completed line of SCAR front brake and clutch reservoir covers



FITS MODEL	DESCRIPTION	PART #
BETA		
RR 125/200 19-24, RR250/300 13-24, RR350/390/430/480 12-24	Clutch reservoir cover	0601-6804
RR Race/X-PRO 125/200/250/300/350/390/430/480 25	Clutch reservoir cover	0601-6804
RX 300 23-25, RX 450 24-25	Clutch reservoir cover	0601-6804
Xtrainer 250 17-25, Xtrainer 300 15-25	Clutch reservoir cover	0601-6804
GASGAS		
MC 125/250/250F/350F/450F 21-22	Front brake and clutch reservoir cover	0601-6804
HUSABERG		
TE 250/300, FE 250/350/501, FX 450 04-14	Front brake reservoir cover	0601-6804
HUSQVARNA		
TC 125/150/250 14-17, 19-25, FC 250/350/450 14-17, 19-25, TE 125/250/300 14-17, 25, FE 250/350/450/501 14-17, 25	Front brake reservoir cover	0601-6804
FC 250/350/450 14-15, TE 150/250/300, FE 250/350/450/501 14-16	Clutch reservoir cover	0601-6804
KTM		
SX 125/150 16-25, SX 250 06-25, SX 300 23-25	Clutch reservoir cover	0601-6804
SX 125/150/250/300, SX-F 250/350/450 05-25	Front brake reservoir cover	0601-6804
SX-F 250 07-25, SX-F 350 10-25, SX-F 450 13-25	Clutch reservoir cover	0601-6804
EXC 150 23-25, EXC 250/300 06-25, EXC 450 07-22	Clutch reservoir cover	0601-6804
EXC 125/250/300 05-25, EXC 150 20-25	Front brake reservoir cover	0601-6804
EXC-F 250 06-25, EXC-F 350 12-25, EXC-F 450/500 07-25	Clutch reservoir cover	0601-6804
EXC-F 250/350/450/500 05-25	Front brake reservoir cover	0601-6804
SHERCO		
SE/SE-R 125/250/300, SEF/SEF-R 250/300/450 10-25	Front brake reservoir cover	0601-6804
TM		
Junior 85 10-25	Clutch reservoir cover	0601-6804
Junior 85 20-25	Front brake reservoir cover	0601-6804
MX/EN 144/250/300/450 10-25	Clutch reservoir cover	0601-6804
MX/EN 144/250/300/450 20-25	Front brake reservoir cover	0601-6804
TRIUMPH		
TF 250-X 24-25	Clutch reservoir cover	0601-6804



EXHAUST

LUGGAGE

BIKE STANDS & ACCESSORIES

HANDLEBARS & HAND CONTROLS

FOOTPEGS & FOOT CONTROLS

BODY

GRAPHICS & SEATS

SPROCKETS

CHAINS

BRAKES

WHEELS & ACCESSORIES

SUSPENSION

ELECTRICAL & GAUGES

LIGHTING

ENGINE

FUEL/AIR SYSTEMS

HARDWARE & MERCHANDISING

+20 MM OFFSET FORGED SHIFT LEVERS

- Designed for riders with larger boot sizes to ensure a better fit and reduced missed shifts due to lever size limit constraints
- The shift lever arm is forged from aircraft-grade 6061 aluminum for maximum strength and durability
- The shift lever tip is machined from billet aluminum for precise fit and function and includes a rustproof stainless steel spring ensuring precise performance in all conditions

- Each tip is finished in a UV protected matte anodizing matching the OEM brand adding a splash of color matching coolness to the bike it fits
- Lighter, stronger and better performing than most OEM stock levers

FITS MODEL	COLOR	PART #
BETA		
RR Race 2T 250 14-16	Red	1602-1632
RR Race 2T 300 13-16	Red	1602-1632
RR 4T Race 350 13-15	Red	1602-1632
RR 4T Race 430 15	Red	1602-1632
RR 4T Race 450 13-14	Red	1602-1632
RR 4T Race 480 15	Red	1602-1632
RR 4T Race 480 20-25	Red	1602-1633
RR 4T Race 498 13-14	Red	1602-1632
RR 2T 125 20-25	Red	1602-1632
RR 2T 200 20-25	Red	1602-1632
RR 2T 250 13-25	Red	1602-1632
RR 2T 300 13-20	Red	1602-1632
RR 4T 350 11-16	Red	1602-1632
RR 4T 390 15-16	Red	1602-1632
RR 4T 400 10-14	Red	1602-1632
RR 4T Factory 400 11	Red	1602-1632
RR 4T 430 15-16	Red	1602-1632
RR 4T 430 20-25	Red	1602-1633
RR 4T 450 10-14	Red	1602-1632
RR 4T Factory 450 11	Red	1602-1632
RR 4T 480 15-16	Red	1602-1632
RR 4T 480 20-25	Red	1602-1633
RR 4T 498 12-14	Red	1602-1632
RR 4T 500 15	Red	1602-1632
RR-S 125 17	Red	1602-1632
RR-S 350 17-19	Red	1602-1632
RR-S 430 17-19	Red	1602-1632
RR-S 4T 350 20-25	Red	1602-1632
RR-S 4T 390 17-25	Red	1602-1632
RR-S 4T 430 20-25	Red	1602-1633
RR-S 500 17-19	Red	1602-1632
RR-S 500 20-25	Red	1602-1633
Xtrainer 300 15-16	Red	1602-1632
Xtrainer 300 20-21	Red	1602-1632
HONDA		
CRF 110F 13-25	Red	1602-1601
CRF 250R 18-25	Red	1602-1602
CRF 250F 19-25	Red	1602-1606
CRF 250RX 19-25	Red	1602-1602
CRF 450R 17-25	Red	1602-1602
CRF 450RWE 19-25	Red	1602-1602
CRF 450RX 17-25	Red	1602-1602
HUSQVARNA		
TC 85 14-17	Blue	1602-1628
TC 85 18-25	Blue	1602-1628
TC 125 14-15	Blue	1602-1625

FITS MODEL	COLOR	PART #
HUSQVARNA (CONT)		
TC 125 16	Blue	1602-1627
TC 125 17-22	Blue	1602-1628
TC 125 23-25	Blue	1602-1630
TC 250 14-16	Blue	1602-1626
TC 250 17-22	Blue	1602-1629
TC 250 23-25	Blue	1602-1630
FC 250 14-16	Blue	1602-1625
FC 250 17-25	Blue	1602-1624
FC 350 14-16	Blue	1602-1625
FC 350 17-25	Blue	1602-1624
FC 450 14-15	Blue	1602-1624
FC 450 16-22	Blue	1602-1627
FC 450 23-25	Blue	1602-1624
TE 125 15-16	Blue	1602-1625
TE 150 17-23	Blue	1602-1628
TE 150 24-25	Blue	1602-1630
TE 250 14-16	Blue	1602-1626
TE 250 17-23	Blue	1602-1629
TE 250 24-25	Blue	1602-1630
TE 300 14-16	Blue	1602-1626
TE 300 17-23	Blue	1602-1629
TE 300 24-25	Blue	1602-1630
FE 250 14-25	Blue	1602-1624
FE 350 14-25	Blue	1602-1624
FE 450 17-25	Blue	1602-1627
FE 501 14-16	Blue	1602-1624
FE 501 17-23	Blue	1602-1627
FE 501 24-25	Blue	1602-1624
KAWASAKI		
KX 60 86-01	Green	1602-1608
KX 65 00-25	Green	1602-1609
KX 80 91-00	Green	1602-1608
KX 80 BW 91-94	Green	1602-1608
KX 85 02-24	Green	1602-1608
KX 100 95-20	Green	1602-1608
KX 112 22-25	Green	1602-1608
KX 125 94-05	Green	1602-1611
KX 250 94-07	Green	1602-1611
KX 500 94-04	Green	1602-1611
KX 450F 16-20	Green	1602-1612
KX 450 21-25	Green	1602-1612
KX 450SR 23-25	Green	1602-1612
KLX 110/L 10-25	Green	1602-1610
KLX 140 08-25	Green	1602-1613
KLX 140G 17-25	Green	1602-1613
KLX 140L 08-25	Green	1602-1613

FITS MODEL	COLOR	PART #
KTM		
SX 85 18-25	Orange	1602-1621
SX 125 98-00	Orange	1602-1617
SX 125 01-15	Orange	1602-1616
SX 125 16	Orange	1602-1620
SX 125 17-22	Orange	1602-1621
SX 125 23-25	Orange	1602-1623
SX 144 07-08	Orange	1602-1616
SX 150 09-15	Orange	1602-1616
SX 150 16	Orange	1602-1620
SX 150 17-22	Orange	1602-1621
SX 200 98-00	Orange	1602-1617
SX 200 01-04	Orange	1602-1616
SX 250 98-00	Orange	1602-1617
SX 250 01-02	Orange	1602-1616
SX 250 03-16	Orange	1602-1617
SX 250 17-22	Orange	1602-1622
SX 250 23-25	Orange	1602-1623
SX 300 98-00	Orange	1602-1617
SX 300 01-02	Orange	1602-1616
SX 300 23-25	Orange	1602-1623
SX 380 98-00	Orange	1602-1617
SX 380 01-02	Orange	1602-1616
SX 400 Race 00-02	Orange	1602-1615
SX 450 Race 03-05	Orange	1602-1615
SX 450 06	Orange	1602-1615
SX 520 Race 00-02	Orange	1602-1615
SX 525 Race 03-05	Orange	1602-1615
SX 525 05-06	Orange	1602-1615
SX 525 Supermoto 04	Orange	1602-1615
SX 540 Race 01	Orange	1602-1615
SX-F 250 05-10	Orange	1602-1617
SX-F 250 12	Orange	1602-1615
SX-F 250 13-16	Orange	1602-1616
SX-F 250 23-25	Orange	1602-1615
SX-F 350 11-16	Orange	1602-1616
SX-F 350 23-25	Orange	1602-1615
SX-F 450 07-12	Orange	1602-1616
SX-F 450 Factory Edition 12-14	Orange	1602-1615
SX-F 450 13-14	Orange	1602-1615
SX-F 450 Factory Edition 15	Orange	1602-1620
SX-F 450 16-22	Orange	1602-1620
SX-F 450 23-25	Orange	1602-1615
SX-F 505 07-08	Orange	1602-1616
SXS 125 01	Orange	1602-1616
SXS 125 06	Orange	1602-1616

+20 MM OFFSET FORGED SHIFT LEVERS continued on next page.



+20 MM OFFSET FORGED SHIFT LEVERS (CONT)

FITS MODEL	COLOR	PART #	FITS MODEL	COLOR	PART #	FITS MODEL	COLOR	PART #
KTM (CONT)			KTM (CONT)			SUZUKI (CONT)		
SXS 250 01	Orange	1602-1615	EXC 450 Race 03	Orange	1602-1615	DR-Z 400 00-04	Gold	1602-1614
SXS 250 07	Orange	1602-1617	EXC 450 05-16 (all)	Orange	1602-1615	DR-Z 400E 00-07, 17	Gold	1602-1614
SXS 450 Race 03-04	Orange	1602-1615	EXC 450 Champions Edition 10	Orange	1602-1615	DR-Z 400S 00-25	Gold	1602-1614
SXS 540 00-03	Orange	1602-1615	EXC 500 12-16	Orange	1602-1615	YAMAHA		
EXC 125 98-00	Orange	1602-1617	EXC 520 Race 00-02	Orange	1602-1615	YZ 60 81-83	Blue	1602-1603
EXC 125 01-03	Orange	1602-1616	EXC 520 Six Days 02	Orange	1602-1615	YZ 80 80-01	Blue	1602-1603
EXC 125 06	Orange	1602-1616	EXC 525 07	Orange	1602-1615	YZ 85 02-25	Blue	1602-1603
EXC 125 07-19	Orange	1602-1621	EXC 525 07	Orange	1602-1615	YZ 250F 01-05, 08-13	Blue	1602-1604
EXC 125 Six Days 02-06	Orange	1602-1616	EXC 525 Race 04-05	Orange	1602-1615	YZ 250F 19-25	Blue	1602-1605
EXC 150 17-23	Orange	1602-1621	EXC 525 Race 04-05	Orange	1602-1615	YZ 250FX 20-25	Blue	1602-1605
EXC 150 24-25	Orange	1602-1623	EXC/EXC-W 530 Six Days 10-12	Orange	1602-1615	YZ 400F 98-99	Blue	1602-1604
EXC 200 98-00	Orange	1602-1617	EXC-F 250 06-08	Orange	1602-1617	YZ 426F 00-02	Blue	1602-1604
EXC 200 01-16	Orange	1602-1616	EXC-F 250 09-10	Orange	1602-1616	YZ 450F 03-13	Blue	1602-1604
EXC 250 98-00	Orange	1602-1617	EXC-F 250/ Six Days 12, 15-24	Orange	1602-1615	YZ 450F 18-25	Blue	1602-1605
EXC 250/Six Days 01-03	Orange	1602-1616	EXC-F 350/Six Days 12-25	Orange	1602-1615	YZ 450FX 19-25	Blue	1602-1605
EXC 250 Race 01-05	Orange	1602-1615	EXC-F 450/Six Days 17-23	Orange	1602-1620	WR 250F 01-06	Blue	1602-1604
EXC 250/Six Days 04-16	Orange	1602-1617	EXC-F 450 24-25	Orange	1602-1615	WR 250F 20-25	Blue	1602-1605
EXC 250/Six Days 17-23	Orange	1602-1622	EXC-F 500/Six Days 17-23	Orange	1602-1620	WR 400F 98-00	Blue	1602-1604
EXC 250 24-25	Orange	1602-1623	EXC-F 500 24-25	Orange	1602-1615	WR 426F 01	Blue	1602-1604
EXC 300 98-00	Orange	1602-1617	EXC-G 450 Race 06	Orange	1602-1615	WR 450F 03-06	Blue	1602-1604
EXC 300/Six Days 01-03	Orange	1602-1616	EXC-G 525 Race 06	Orange	1602-1615	WR 450F 19-25	Blue	1602-1605
EXC 300/Six Days 04-16	Orange	1602-1617	EXC-R 450 08	Orange	1602-1615	TR 225 99-04	Blue	1602-1603
EXC 300/Six Days 17-23	Orange	1602-1622	EXC-R 530 08	Orange	1602-1615	TR 230 05-25	Blue	1602-1603
EXC 300 24-25	Orange	1602-1623	EXE 125 00-01	Orange	1602-1616	IT 125 80-81	Blue	1602-1603
EXC 380 98-00	Orange	1602-1617	Rally Replica 450 16-22	Orange	1602-1620	IT 175 77-79	Blue	1602-1603
EXC 380 01-02	Orange	1602-1616	SUZUKI			IT 250 77-80	Blue	1602-1603
EXC 400 Race 00-05	Orange	1602-1615	RMX 250 89-98	Gold	1602-1614	IT 425 80	Blue	1602-1603
EXC 400 Race Six Days 02	Orange	1602-1615				TT 500 79-81	Blue	1602-1603
EXC 400 07, 09-10	Orange	1602-1615						

KNURLED SHIFT TIPS

- Replacement knurled shift lever tip for use on Hammerhead™ CNC shift levers
- Aggressively knurled grip
- Stainless steel mounting hardware included
- Precision machined from 6061 billet aluminum
- Anodized and UV coated for long lasting color
- Will NOT work with the Hammerhead™ forged shift levers.



COLOR	+0 MM PART #	+20 MM PART #	COLOR	+0 MM PART #	+20 MM PART #
Black	1602-1642	1602-1648	Green	1602-1639	1602-1645
Blue	1602-1638	1602-1644	Orange	1602-1640	1602-1646
Gold	1602-1641	1602-1647	Red	1602-1637	1602-1643



FORGED SHIFT LEVERS

- Moose Racing has teamed up with Hammerhead to bring you the ultimate shift lever
- The forged shift lever arm is manufactured from aircraft-grade 6061 aluminum
- Anodized in a matte finish
- The tips are anodized in colors per bike brand
- Shift lever tip is a finely machined full CNC part with stainless steel spring
- Anodized with UV protection to preserve color
- See pages 272-273 of the 2024 Parts Europe Offroad catalog for Moose Racing's complete line of Forged Shift Levers

FITS MODEL	TIP COLOR	PART #	FITS MODEL	TIP COLOR	PART #
HONDA			KAWASAKI (CONT)		
CRF 250F 19-25	Red	1602-1595	KX 450F 06-15	Green	1602-0844
HUSQVARNA			KLX 450R 07-08	Green	1602-0844
TC 125 23-25	Blue	1602-1599	KTM		
TC 250 23-25	Blue	1602-1599	SX 125 23-25	Orange	1602-1598
TE 150 24-25	Blue	1602-1599	SX 250 23-25	Orange	1602-1598
TE 250 24-25	Blue	1602-1599	EXC 150 24-25	Orange	1602-1598
TE 300 24-25	Blue	1602-1599	EXC 250 24-25	Orange	1602-1598
KAWASAKI			EXC 300 24-25	Orange	1602-1598
KX 65 00-25	Green	1602-0839			



ALUMINUM SHIFTERS

- Manufactured from high-grade aluminum
- Lower cost, yet higher quality than stock replacements
- Folding shift tip is knurled for accurate shifts
- Tip and lever assembled with bolt instead of rivets
- Replaceable pivot hardware allows for extended shift lever life

FITS MODEL	PART #
KAWASAKI	
KX 60 85-03	1602-0257
KX 80/85/100 86-13	1602-0257
KX 125/250 92-93	1602-0257

FITS MODEL	PART #
KTM	
SX 125/144/150/200 01-12	1602-0254
SX 250 01-02	1602-0254
SX-F 350/450/505 07-09	1602-0254
EXC 125/144/150/200 01-12	1602-0254

FITS MODEL	PART #
KTM (CONT)	
EXC 250 01-03	1602-0254
SUZUKI	
RM 100 03	1602-0257



- Replacement pin available; PART #1602-0392
- See page 274 of the 2024 Parts Europe Offroad catalog for Moose Racing's complete line of aluminum shifters

GEAR SHIFT LEVERS

- Made from forged aluminum
- Anodized, CNC-machined tip
- Knurled tip for better grip
- Available in black
- See page 275 of the 2024 Parts Europe Offroad catalog for the complete line of SCAR gear shift levers

FITS MODEL	PART #
GASGAS	
MC 65 21-25	1602-1659

FITS MODEL	PART #
HUSQVARNA	
TC 65 17-25	1602-1659

FITS MODEL	PART #
KTM	
SX 65 09-25	1602-1659



BRAKE PEDALS

- Moose Racing has teamed up with Hammerhead to bring you the ultimate brake pedal
- The brake pedal arms are forged from 6061 with stainless steel clevis pin sleeves and brass mounting bolt sleeve bushings
- Brake tip is a finely machined CNC part with stainless steel set screws for durability and grip
- Brake tip can be adjusted for length in two mounting positions and is connected with stainless steel socket screws
- The brake pedal arm is anodized in a matte black finish and the tips are anodized in colors per bike brand
- Brake pedal includes a CNC brake clevis, also anodized in colors per bike brand with a stainless steel pin (except KTM)

- KTM brake pedals include two precision bearings at the mounting point
- Every brake pedal also comes with a stainless steel brake snake
- Anodized with UV protection to preserve color
- See pages 280-281 of the 2024 Parts Europe Offroad catalog for Moose Racing's complete line of brake pedals

FITS MODEL	TIP COLOR	PART #
HONDA		
CRF 125F 14-25	Red	1610-0721
CRF 250F 19-25	Red	1610-0724
XR 650L 93-25	Red	1610-0722
HUSQVARNA		
TC 125 23-25	Blue	1610-0720
TC 250 23-25	Blue	1610-0720
FC 250 23-25	Blue	1610-0720
FC 350 23-25	Blue	1610-0720
FC 450 23-25	Blue	1610-0720
TE 150 24-25	Blue	1610-0720
TE 250 24-25	Blue	1610-0720

FITS MODEL	TIP COLOR	PART #
HUSQVARNA (CONT)		
TE 300 24-25	Blue	1610-0720
FE 250 24-25	Blue	1610-0720
FE 350 24-25	Blue	1610-0720
FE 450 24-25	Blue	1610-0720
FE 501 24-25	Blue	1610-0720
KTM		
SX 125 23-25	Orange	1610-0719
SX 250 23-25	Orange	1610-0719
SX-F 250 23-25	Orange	1610-0719
SX-F 350 23-25	Orange	1610-0719
SX-F 450 23-25	Orange	1610-0719

FITS MODEL	TIP COLOR	PART #
KTM (CONT)		
EXC 150 24-25	Orange	1610-0719
EXC 250 24-25	Orange	1610-0719
EXC 300 24-25	Orange	1610-0719
EXC-F 250 24-25	Orange	1610-0719
EXC-F 350 24-25	Orange	1610-0719
EXC-F 450 24-25	Orange	1610-0719
EXC-F 500 24-25	Orange	1610-0719
YAMAHA		
YZ 250F 24-25	Blue	1610-0723
YZ 450F 23-25	Blue	1610-0723
YZ 450FX 24-25	Blue	1610-0723



PRO REAR BRAKE RETURN SPRING KITS WITH CAP

- Pro Rear Brake Return Spring replaces the original equipment rear brake return spring configuration on most Honda, Kawasaki, Suzuki and Yamaha MX models
- Robust design improves rear brake pedal return performance over stock
- Provides more precise pedal feedback while riding

DESCRIPTION	PART #
Fits most Honda, Suzuki and Yamaha MX models	1610-0730

- Kit includes replacement spring and spring cap
- Mounts between the rear master cylinder and the clevis
- UV anodized cap improves durability and corrosion resistance

NOTE: Kit does NOT include rear brake clevis.

DESCRIPTION	PART #
Fits most Kawasaki MX models	1610-0731

1610-0730



EXHAUST

LUGGAGE

BIKE STANDS & ACCESSORIES

HANDLEBARS & HAND CONTROLS

FOOTPEGS & FOOT CONTROLS

BODY

GRAPHICS & SEATS

SPROCKETS

CHAINS

BRAKES

WHEELS & ACCESSORIES

SUSPENSION

ELECTRICAL & GAUGES

LIGHTING

ENGINE

FUEL/AIR SYSTEMS

HARDWARE & MERCHANDISING

FOOTPEGS & FOOT CONTROLS

EXHAUST

LUGGAGE

BIKE STANDS & ACCESSORIES

HANDLEBARS & HAND CONTROLS

FOOTPEGS & FOOT CONTROLS

BODY

GRAPHICS & SEATS

SPROCKETS

CHAINS

BRAKES

WHEELS & ACCESSORIES

SUSPENSION

ELECTRICAL & GAUGES

LIGHTING

ENGINE

FUEL/AIR SYSTEMS

HARDWARE & MERCHANDISING



Blue



Orange



Red



REAR BRAKE PEDAL PADS

- Precision machined from 6061-T6 aluminum with corrosion-resistant stainless steel mounting hardware
- Three adjustment holes allows you to dial in brake pedal length for smaller to larger boot sizes
- Anodized color options available to either match most OEMs or match lever arm with black

- Replaces standard size pad on all Moose Racing Forged Rear Brake Pedals
- Includes two mounting bolts

COLOR	PART #
Black	1610-0740
Blue	1610-0734
Gold	1610-0738

COLOR	PART #
Green	1610-0735
Orange	1610-0736
Red	1610-0733



TITANIUM BRAKE PEDAL PAD

- Titanium brake pedal pad is 6 mm wider (1/4") and 6 mm longer (1/4") than OEM
- The "racer's tip" is ultra lightweight
- Includes stainless steel mounting hardware
- Fits ALL Hammerhead™ CNC and Forged rear brake pedals
- Fits some KTM/Beta OEM rear brake pedals



DESCRIPTION	PART #
Titanium rear brake pedal pad	1610-0732



TITANIUM BRAKE TIP

- Made from aerospace-grade Ti-6Al-4V titanium
- Super-grippy full-titanium tip
- Ultra lightweight
- Premium quality and high-performance construction
- Longer than OEM
- Eliminates the risk of brake loss
- For the full line of SCAR titanium brake tips see page 296 of the 2024 Parts Europe Offroad catalog



FITS MODEL	PART #	FITS MODEL	PART #	FITS MODEL	PART #
BETA		HUSABERG (CONT)		KTM (CONT)	
RR 125/200/250/300/350/390/430/480 15-24	1620-2688	FE 570 09-11	1620-2688	SX 125 04-15	1620-2688
RR Race/X-Pro 125-480 25	1620-2688	HUSQVARNA		SX 150 09-15	1620-2688
Xtrainer 250/300 15-25	1620-2688	TC 65 17-23	1620-2688	SX 250 03-16	1620-2688
GASGAS		TC 85 14-17	1620-2688	SX-F 250 06-15	1620-2688
MC 65 21-23	1620-2688	FC 250/350/450 14-15	1620-2688	SX-F 350 11-15	1620-2688
EC 200/250/250F/300/350F/450F 12-14	1620-2688	TE 125 15-16	1620-2688	SX-F 450 07-15	1620-2688
HUSABERG		FE 250/350/450/501 14-16	1620-2688	EXC 125/200/250/300 05-16	1620-2688
TE 250/300 12-13	1620-2688	701 Enduro 16-24	1620-2688	EXC-F 250 07-16	1620-2688
FE 250/350 13	1620-2688	KTM		EXC-F 350 12-16	1620-2688
FE 450 09	1620-2688	SX 65 09-23	1620-2688	XC 150 08-09	1620-2688
FE 501 13	1620-2688	SX 85 03-17	1620-2688	XC 300 06-10	1620-2688
		SX 105 04-10	1620-2688	690 Enduro R 10-24	1620-2688



- EXHAUST
- LUGGAGE
- BIKE STANDS & ACCESSORIES
- HANDLEBARS & HAND CONTROLS
- FOOTPEGS & FOOT CONTROLS
- BODY
- GRAPHICS & SEATS
- SPROCKETS
- CHAINS
- BRAKES
- WHEELS & ACCESSORIES
- SUSPENSION
- ELECTRICAL & GAUGES
- LIGHTING
- ENGINE
- FUEL/AIR SYSTEMS
- HARDWARE & MERCHANDISING

TI FOOTPEGS

- Made from aerospace-grade titanium Grade 5 Ti-6AL-4V with chamber-controlled welding
- 57 mm cleated platform provides ample surface area and support for the most aggressive riding
- Super lightweight coming in under 300 grams per set
- Inner cleated webbing design provides added traction surface and strength to the footpegs
- Beveled front and rear edges prevent pegs from hanging up in deep ruts
- See page 284 of the 2024 Parts Europe Offroad catalog for Moose Racing's complete line of Ti footpegs



1620-2522

FITS MODEL	PART #	FITS MODEL	PART #	FITS MODEL	PART #	FITS MODEL	PART #
GASGAS		HUSQVARNA (CONT)		KTM		KTM (CONT)	
MC 250 24-25	1620-2522	FC 350 23-25	1620-2522	SX 125 23-25	1620-2522	EXC 300 24-25	1620-2522
MC 250F 24-25	1620-2522	FC 450 23-25	1620-2522	SX 150 23-25	1620-2522	EXC-F 250 24-25	1620-2522
MC 350F 24-25	1620-2522	TE 150 24-25	1620-2522	SX 250 23-25	1620-2522	EXC-F 350 24-25	1620-2522
MC 450F 24-25	1620-2522	TE 250 24-25	1620-2522	SX-F 250 23-25	1620-2522	EXC-F 450 24-25	1620-2522
HUSQVARNA						YAMAHA	
TC 125 23-25	1620-2522	TE 300 24-25	1620-2522	SX-F 350 23-25	1620-2522	YZ 250F 24-25	1620-2521
TC 250 23-25	1620-2522	FE 250 24-25	1620-2522	SX-F 450 23-25	1620-2522	YZ 450F 23-25	1620-2521
FC 250 23-25	1620-2522	FE 350 24-25	1620-2522	EXC 150 24-25	1620-2522	WR 450F 24-25	1620-2521
		FE 450 24-25	1620-2522	EXC 250 24-25	1620-2522		

QUALIFIER FOOTPEGS

- Two-piece lightweight footpeg design
- CNC-machined aluminum alloy construction
- Extra-wide replaceable stainless steel footplate providing the rider with ultimate grip
- The stainless steel footplate also sits inside a rubber damper, helping to absorb shock
- Use your OEM springs
- Available in black only
- Replacement footplate PART #1620-1738 available separately
- See page 289 of the 2024 Parts Europe Offroad catalog for the complete line of Moose Racing Qualifier Footpegs



1620-2631

FITS MODEL	PART #	FITS MODEL	PART #	FITS MODEL	PART #
HONDA		HONDA (CONT)		YAMAHA	
CRF 110F 13-25	1620-2632	CRF 125F 14-25	1620-2632	YZ 450F 23	1620-2631

ADVENTURE SPORT QUALIFIER FOOTPEGS

- Moose's most popular footpegs now fit a number of popular Adventure Sport models
- Aggressive claw boot surface improves grip and stability in various riding conditions
- Polished stainless steel footplate sits inside rubber isolator to minimize primary vibration
- Two-piece light weight design includes wide replaceable stainless steel footplate
- CNC-machined aluminum alloy construction
- Durable gloss black powdercoated finish with Moose Racing logo
- Allows use of OEM springs for installation



1620-2621

FITS MODEL	PART #	FITS MODEL	PART #	FITS MODEL	PART #
SUZUKI		SUZUKI (CONT)		SUZUKI (CONT)	
DR-Z 400S 00-24	1620-2624	DR 650SE 09-22	1620-2621	V-Strom 1050XT 20	1620-2623

HYBRID FOOTPEGS

- Each footpeg is cast from 17-4 stainless steel, given a solution-annealing treatment, and age-hardened for superior strength
- 57 mm (2 1/4") W x 90 mm (3 1/2") L
- Slightly convex platform for better boot positioning and grip when leaning forward or back
- Dual-plane teeth provide traction without the "stuck" feeling
- Available with 13 mm (1/2") rear offset to allow more space
- Use your OEM springs
- For the full line of Hybrid Footpegs, see pages 289-290 of the 2024 Parts Europe Offroad catalog
- Sold in pairs



FITS MODEL	PART #	FITS MODEL	PART #	FITS MODEL	PART #	FITS MODEL	PART #
KAWASAKI		SUZUKI		SUZUKI (CONT)		SUZUKI (CONT)	
KLX 400 03-06	1620-0774	RM 125/250 91-02	1620-0774	DR-Z 400 00-04	1620-0774	DR-Z 400S 00-09	1620-0774
		RMX 250 93-98	1620-0774	DR-Z 400E 00-07	1620-0774	DR-Z 400SM 05-09	1620-0774

FOOTPEGS & FOOT CONTROLS

EXHAUST



LUGGAGE

TITANIUM FOOTPEGS

- High-quality aerospace-grade titanium
- Ultralight design
- Premium quality and high performance
- Designed for maximum strength and grip
- Available in gripper and anti-mud versions
- Gripper footpegs have larger teeth for extra grip, while anti-mud footpegs offer more protection in sloppy conditions
- See page 295 of the 2024 Parts Europe Offroad catalog for the complete line of SCAR titanium footpegs



BIKE STANDS & ACCESSORIES

HANDLEBARS & HAND CONTROLS

FITS MODEL	GRIPPER FOOTPEGS	ANTI-MUD FOOTPEGS
STARK		
Varg 23-25	1602-1660	1602-1662

FITS MODEL	GRIPPER FOOTPEGS	ANTI-MUD FOOTPEGS
TRIUMPH		
TF 250-X 24-25	1602-1661	1602-1663

FOOTPEGS & FOOT CONTROLS



BODY

EVOLUTION RACING FOOTPEGS

- The Evolution of the Standard footpeg; Scar is the inventor of footpegs with integrated component teeth (a registered design)
- Made from high-quality aerospace aluminum, then CNC machined; 40% lighter and 20% more resistant than OEM
- Exceptional grip with the new sharpened teeth made out of high-strength tempered steel
- The body of the footpeg is 57 mm wide (+10 mm compared to the stock pegs)
- Improved comfort and better control, thanks to an increased width, which provides 30% more surface area for greater shock absorption during high "G" loading (casing jumps, etc.)



1602-1576

SPROCKETS

FITS MODEL	COLOR	PART #
YAMAHA		
YZ 250F 24-25	Blue	1602-1576
YZ 450F 23-25	Blue	1602-1576

- Ideal for extreme conditions such as sand or mud
- For the full line of SCAR Evolution Racing footpegs see pages 293-294 of the 2024 Parts Europe Offroad catalog

DESCRIPTION	PART #
FOOTPEG SPRINGS	
Left spring	1602-1442
Right spring	1602-1443

CHAINS

BRAKES



STANDARD FOOTPEGS

- Scar is the inventor of footpegs with integrated component teeth (a registered design)
- Made from high-quality aerospace aluminum and then CNC machined
- 18 teeth made of high-resistance stainless steel for strength and extra grip
- Footpeg is 48 mm wide, with flat teeth
- Improve comfort and grip compared to the stock pegs
- Available in black
- For the full line of standard footpegs see page 294 of the 2024 Parts Europe Offroad catalog



SUSPENSION

FITS MODEL	PART #	FITS MODEL	PART #	FITS MODEL	PART #
GASGAS		HUSQVARNA		KTM	
MC 125 23-25	1602-1575	TC 125/FC 250 23-25	1602-1575	SX 125, SX/SX-F 250 23-25	1602-1575

ELECTRICAL & GAUGES



FOOTPEG SPRING AND PIN KITS

- Designed to replace OEM stock footpeg pin and spring
- Will work with most aftermarket footpegs
- Includes two OEM replacement springs, two OEM replacement pins, two washers and two cotter keys
- See page 297 of the 2024 Parts Europe Offroad catalog for the complete line of Moose Racing Footpeg Spring and Pin kits



1602-2635



1602-1578

LIGHTING



FOOTPEG SPRINGS

- Aluminum construction
- Fit Evolution Racing footpegs
- Sold each

ENGINE

FUEL/AIR SYSTEMS

FITS MODEL	PART #	FITS MODEL	PART #	FITS MODEL	LEFT PART #	RIGHT PART #
KTM		SHERCO		YAMAHA		
SX 125/250 23-25	1602-2633	SM-R 50 21	1602-2635	YZ 250F 24-25	1602-1578	1602-1579
SX 150 24	1602-2633	YZ 450F 23-24	1602-2634	YZ 450F 23-25	1602-1578	1602-1579
SX-F 250 23-24	1602-2633					
SX-F 350/450 23-25	1602-2633					



REPLACEMENT PLASTIC FOR HONDA

- Either color-matched to OEM or in optional works colors
- Predrilled pieces mount easily
- Radiator covers and side panels are sold in pairs

• See pages 304-311 of the 2024 Parts Europe Offroad catalog for the complete line of UFO Replacement Plastic for Honda

FULL BODY KITS FOR HONDA

- Replace all your plastic at once
- OEM matches stock bike colors; all black, all white and other colors also available
- Molded-in colored parts won't show a different color when scratched
- Predrilled pieces mount easily to stock
- Full body kits include front and rear fender, radiator cover, side panels, fork guards and front number plate

Individual pieces of Replacement Plastic also available.



1403-4126

FULL BODY KITS

FITS MODEL	COLOR	PART #	FITS MODEL	COLOR	PART #
CRF 250R/RWE/RX, CRF 450R/RWE/RX 25	OEM	1403-4125	CRF 250R/RWE/RX, CRF 450R/RWE/RX 25 (CONT)	Black	1403-4127
	Red	1403-4126		White	1403-4128



0520-4101



0520-4103



0520-4105

RADIATOR COVERS

FITS MODEL	COLOR	PART #
CRF 250R/RWE/RX 25	Red	0520-4101
	Black	0520-4102

SIDE PANELS

FITS MODEL	COLOR	PART #
CRF 250R/RWE/RX, CRF 450R/RWE/RX 25	OEM	0520-4103
	Red	0520-4104
	Black	0520-4105
	White	0520-4106

REPLACEMENT PLASTIC FOR HUSQVARNA

- Either color-matched to OEM or in optional works colors
- Predrilled pieces mount easily to stock
- Radiator covers and side panels sold in pairs

FULL BODY KITS FOR HUSQVARNA

- Replace all your plastic at once
- OEM matches stock bike colors; all black, all white and other colors also available
- Molded-in colored parts won't show a different color when scratched
- Predrilled pieces mount easily to stock
- Full body kits include front and rear fender, radiator cover, side panels, fork guards and front number plate

UFO individual pieces of Replacement Plastic also available.



1403-4131

FULL BODY KITS

FITS MODEL	COLOR	PART #	FITS MODEL	COLOR	PART #
TC 125/150/250/300, FC 250/350/450 25	OEM 25	1403-4129	TC 250, FC 250/350/450 23-24	OEM 23-24	1403-4131
	Black	1403-4130	TE 150/250/300, FE 250/350/450/501 24-25	OEM 24-25	1403-4132

RADIATOR COVERS

FITS MODEL	COLOR	PART #
TC 125/150/250/300, FC 250/350/450 25	Gray	0520-4108
	White	0520-4107
	Black	0520-4109

AIRBOX COVERS

FITS MODEL	COLOR	PART #
TC 125/150/250/300, FC 250/350/450 25	White	0520-4113
	Black	0520-4114
	White	0520-4115 ¹
	Black	0520-4116 ¹

¹ Vented.

FRAME GUARDS

FITS MODEL	COLOR	PART #
TC 125/150/250/300, FC 250/350/450 25	Black	0505-2501



0520-4110



0520-4112

FRONT NUMBER PLATES

FITS MODEL	COLOR	PART #
TC 125/250, FC 250/350/450 23-25, TC 150/300 25	OEM 23	0520-4111
	OEM 24-25	0520-4110
	Black	0520-4112

EXHAUST

LUGGAGE

BIKE STANDS & ACCESSORIES

HANDLEBARS & HAND CONTROLS

FOOTPEGS & FOOT CONTROLS

BODY

GRAPHICS & SEATS

SPROCKETS

CHAINS

BRAKES

WHEELS & ACCESSORIES

SUSPENSION

ELECTRICAL & GAUGES

LIGHTING

ENGINE

FUEL/AIR SYSTEMS

HARDWARE & MERCHANDISING

EXHAUST



LUGGAGE

REPLACEMENT PLASTIC FOR KTM

- Choose either color-matched to OEM or optional works colors
- Predrilled pieces mount easily to stock locations
- Radiator covers sold in pairs

• See pages 326-335 of the 2024 Parts Europe Offroad catalog for the complete line of UFO Replacement Plastic for KTM

BIKE STANDS & ACCESSORIES

HANDLEBARS & HAND CONTROLS

FOOTPEGS & FOOT CONTROLS

BODY



1403-4133

FULL BODY KITS FOR KTM

- Replace all your plastic at once
- OEM matches stock bike colors; all black, all white and other colors also available
- Molded-in colored parts won't show a different color when scratched
- Predrilled pieces mount easily to stock

UFO individual pieces of Replacement Plastic also available.

FULL BODY KITS

FITS MODEL	COLOR	PART #
SX 125/250/300, SX-F 250/350/450 25	Orange	1403-4133
	Neon orange	1403-4134
	Black	1403-4135
	White	1403-4136

FITS MODEL	COLOR	PART #
EXC 150/250/300, EXC-F 250/350/450/500 24-25	OEM 25	1403-4137

SPROCKETS

RADIATOR COVERS

FITS MODEL	COLOR	PART #
SX 125/250/300, SX-F 250/350/450 25	Orange	0520-4117
	Neon orange	0520-4118

FITS MODEL	COLOR	PART #
SX 125/250/300, SX-F 250/350/450 25 (CONT)	Black	0520-4119
	White	0520-4120

CHAINS



REPLACEMENT PLASTIC FOR BETA

- Created using many exclusive and patented methods including DGP - Durable Gloss Polypropylene - Polisport's own developed technology that combines the highest levels of resistance and flex while maintaining a superior gloss finish and color brightness
- Injection-molded, quality plastic components with a perfect OEM fit
- Exact replica of stock OEM plastic components but stronger
- Inexpensive alternative to OEM replacement parts

- Stock color match
- Glossy and flexible
- Less prone to scratches
- See pages 352-353 of the 2024 Parts Europe Offroad catalog for additional Beta replacement plastic applications

BRAKES

WHEELS & ACCESSORIES

SUSPENSION



ELECTRICAL & GAUGES

LIGHTING

FULL BODY KITS

FITS MODEL	COLOR	PART #
RR 2T 125/200/250/300 23-24, RR 4T 350/390/430/480 23-24	OEM	1403-4076



0520-3986



0520-3988



0520-3987

ENGINE

FUEL/AIR SYSTEMS

RADIATOR SCOOPS

FITS MODEL	COLOR	PART #
RR 2T 125/200/250/300 23-24, RR 4T 350/390/430/480 23-24	OEM red/black	0520-3986
	Black	0520-3988

FITS MODEL	COLOR	PART #
RR 2T 125/200/250/300 23-24, RR 4T 350/390/430/480 23-24 (CONT)	White/black	0520-3987



REPLACEMENT PLASTIC FOR SHERCO

- Created using many exclusive and patented methods including DGP - Durable Gloss Polypropylene - Polisport's own developed technology that combines the highest levels of resistance and flex while maintaining a superior gloss finish and color brightness
- Injection-molded, quality plastic components with a perfect OEM fit
- Exact replica of stock OEM plastic components but stronger

- Inexpensive alternative to OEM replacement parts
- Stock color match
- Glossy and flexible
- Less prone to scratches
- See pages 354-355 of the 2024 Parts Europe Offroad catalog for additional Polisport replacement plastic for Sherco applications



1403-4078

FULL BODY KITS

FITS MODEL	COLOR	PART #
SE-R 250/300 24, SEF-R 250/350/450/500 24	OEM	1403-4078
	S-blue/white	1403-4077

FITS MODEL	COLOR	PART #
SE Factory 125/250/300 25, SEF-R Factory 250/350/450/500 25	OEM	1403-4100
	White	1403-4101

FORK GUARDS

FITS MODEL	COLOR	PART #
SE-R 125 18-25, SE-R 250/300 17-25, SEF-R 250 17-25, SEF-R 300/450/500 18-25	OEM S-blue	0412-0664



RADIATOR SCOOPS

FITS MODEL	COLOR	PART #
SE-R 125/250/300 25, SEF-R 250/300/450/500 25	OEM S-blue	0520-4063



SIDE PANELS

FITS MODEL	COLOR	PART #
SE-R 125/250/300 25, SEF-R 250/300/450/500 25	OEM N-gray	0520-4065



HEADLIGHT MASKS

FITS MODEL	COLOR	PART #
SE-R 125/250/300 24-25, SEF-R 250/300/450/500 24-25	OEM white	0520-4042
	Gray	0520-4062

0520-4042



AIRBOX COVER

FITS MODEL	COLOR	PART #
SE-R 125/250/300 25, SEF-R 250/300/450/500 25	OEM N-Gray	0520-4064

0520-4064



FENDERS

FITS MODEL	POS.	COLOR	PART #
SEW-R 125/250/300 24-25, SEF-R 250/300/450/500 24-25	Front	OEM blue	1403-4081
SE-R 125/250/300 25, SEF-R 250/300/450/500 25	Rear	OEM N-gray	1403-4102

1403-4081



1403-4102



REPLACEMENT PLASTIC FOR GASGAS

- Polisport's plastics are produced with Polisport's exclusive technology - DGP (durable gloss polypropylene) - making them more durable, with a perfect combination of resistance and flexibility
- Polisport replica plastics have a glossy finish and colors that perfectly match the stock part
- See pages 358-359 of the 2024 Parts Europe Offroad catalog for additional GASGAS replacement plastic



SWINGARM GUARD

FITS MODEL	COLOR	PART #
MC 125/250 24-25, MC-F 250/350/450 24-25, EC 250/300 24-25, EC-F 250/350/450/500 24-25, EW 500F 24-25	Black	1303-0382

EXHAUST

LUGGAGE

BIKE STANDS & ACCESSORIES

HANDLEBARS & HAND CONTROLS

FOOTPEGS & FOOT CONTROLS

BODY

GRAPHICS & SEATS

SPROCKETS

CHAINS

BRAKES

WHEELS & ACCESSORIES

SUSPENSION

ELECTRICAL & GAUGES

LIGHTING

ENGINE

FUEL/AIR SYSTEMS

HARDWARE & MERCHANDISING

EXHAUST

REPLACEMENT PLASTIC FOR HONDA

- Polisport's plastics are produced with Polisport's exclusive technology – DGP (durable gloss polypropylene) – making them more durable, with a perfect combination of resistance and flexibility
- Polisport replica plastics have a glossy finish and colors that perfectly match the stock parts
- See pages 362-363 of the 2024 Parts Europe Offroad catalog for additional replacement plastic for Honda

LUGGAGE

BIKE STANDS & ACCESSORIES

HANDLEBARS & HAND CONTROLS

FOOTPEGS & FOOT CONTROLS

BODY



RESTYLE FULL BODY KITS

FITS MODEL	COLOR	PART #
CR 125R/250R 00-01	Red (22 body style)	1403-4036
	Black (22 body style)	1403-4037

SPROCKETS



CHAINS



BRAKES

FORK GUARDS

FITS MODEL	COLOR	PART #
CR 125R/250R 95-03, CR 500R 95-02, CRF 450R 02-03	White	0412-0363

FULL WRAP FORK GUARDS

FITS MODEL	COLOR	PART #
CRF 250/450R/RX 19-25	White	0412-0606

WHEELS & ACCESSORIES



SUSPENSION

RESTYLE RADIATOR COVERS

FITS MODEL	COLOR	PART #
CR 125R/250R 00-01	Red (22 body style)	0520-3982
	Black (22 body style)	0520-3983

RESTYLE SIDE PANELS

FITS MODEL	COLOR	PART #
CR 125R/250R 00-01	Red (22 body style)	0520-3984
	Black (22 body style)	0520-3985

ELECTRICAL & GAUGES

LIGHTING

SWINGARM GUARDS

FITS MODEL	COLOR	PART #
CRF 250R 18-19, CRF 250RX 19, CRF 450R/RX 17-18	Gray	1303-0344

FITS MODEL	COLOR	PART #
CRF 250R/RX 20-24, CRF 450R/RX 19-24	Gray	1303-0345

ENGINE

REPLACEMENT PLASTIC FOR HUSQVARNA

- Polisport's plastics are produced with Polisport's exclusive technology – DGP (durable gloss polypropylene) – making them more durable, with a perfect combination of resistance and flexibility
- Polisport replica plastics have a glossy finish and colors that perfectly match the stock parts
- See pages 366-369 of the 2024 Parts Europe Offroad catalog for additional Husqvarna replacement plastic



HARDWARE & MERCHANDISING

SWINGARM GUARD

FITS MODEL	COLOR	PART #
TC 125/250 23-25, FC 250/350/450 23-25, TE 150/250/300 24-25, FE 250/350/450/501 24-25	Black	1303-0382



REPLACEMENT PLASTIC FOR KAWASAKI

- Polisport's plastics are produced with Polisport's exclusive technology - DGP (durable gloss polypropylene) - making them more durable, with a perfect combination of resistance and flexibility
- Polisport replica plastics have a glossy finish and colors that perfectly match the stock parts

• See pages 370-373 of the 2024 Parts Europe Offroad catalogue for additional Kawasaki replacement plastic

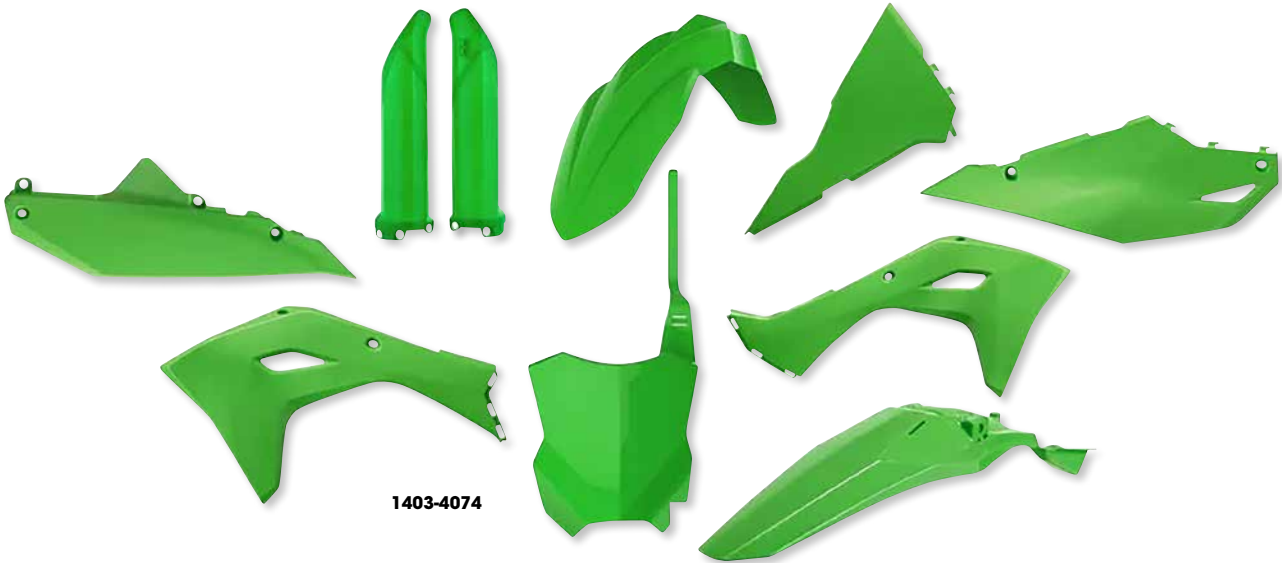

FULL BODY KITS WITH FORK GUARDS

FITS MODEL	COLOR	PART #
KX 250 25, KX 450/X 24-25	OEM green	1403-4074
	Black	1403-4075

RADIATOR SCOOPS

FITS MODEL	COLOR	PART #
KX 250/X 25, KX 450/X 24-25	OEM green	0520-4039



AIRBOX COVER

FITS MODEL	COLOR	PART #
KX 250 25, KX 450/X 24-25	OEM green	0520-4040



REAR FENDER

FITS MODEL	COLOR	PART #
KX 250/X 25, KX 450/X 24-25	OEM green	1403-4083



SIDE PANELS

FITS MODEL	COLOR	PART #
KX 250/X 25, KX 450/X 24-25	OEM green	0520-4037



REPLACEMENT PLASTIC FOR KTM

- Polisport's plastics are produced with Polisport's exclusive technology - DGP (durable gloss polypropylene) - making them more durable, with a perfect combination of resistance and flexibility
- Polisport replica plastics have a glossy finish and colors that perfectly match the stock parts

• See pages 378-383 of the 2024 Parts Europe Offroad catalogue for additional replacement plastic

PDS GUARD

- Preserves the PDS linkage from deterioration over time
- Also serves as a brake cable holder
- Durable construction that resists abrasion



PDS GUARDS

FITS MODEL	COLOR	PART #
EXC 125 17, EXC 250/300 17-23, EXC-F 17-23 (all)	Orange	0506-2120
	Black	0506-2119

SWINGARM COVER

FITS MODEL	COLOR	PART #
SX 125/150/250 23-25, SX-F 250/350/450 23-25, EXC 250/350 24-25, EXC-F 250/350/450/500 24-25	Black	1303-0382



EXHAUST

LUGGAGE

BIKE STANDS & ACCESSORIES

HANDLEBARS & HAND CONTROLS

FOOTPEGS & FOOT CONTROLS

BODY

GRAPHICS & SEATS

SPROCKETS

CHAINS

BRAKES

WHEELS & ACCESSORIES

SUSPENSION

ELECTRICAL & GAUGES

LIGHTING

ENGINE

FUEL/AIR SYSTEMS

HARDWARE & MERCHANDISING

EXHAUST

LUGGAGE

BIKE STANDS & ACCESSORIES

HANDLEBARS & HAND CONTROLS

FOOTPEGS & FOOT CONTROLS

BODY

GRAPHICS & SEATS

SPROCKETS

CHAINS

BRAKES

WHEELS & ACCESSORIES

SUSPENSION

ELECTRICAL & GAUGES

LIGHTING

ENGINE

FUEL/AIR SYSTEMS

HARDWARE & MERCHANDISING

REPLACEMENT PLASTIC FOR YAMAHA

- Polisport's plastics are produced with Polisport's exclusive technology – DGP (durable gloss polypropylene) – making them more durable, with a perfect combination of resistance and flexibility
 - Polisport replica plastics have a glossy finish and colors that perfectly match the stock parts
- See pages 390-393 of the 2024 Parts Europe Offroad catalog for additional replacement plastic for Yamaha



BODY RESTYLE KITS

FITS MODEL	COLOR	PART #	FITS MODEL	COLOR	PART #
YZ 125/250 02-21	OEM blue (22 body style)	1403-4079	YZ 125/250 02-21 (CONT)	White (22 body style)	1403-4099
	Black (22 body style)	1403-4098			

FULL WRAP FORK GUARDS

FITS MODEL	COLOR	PART #
YZ 125/250 15-25, YZ 250F/YZ 450F 10-25, YZ 250FX 16-15, YZ 450FX 15-25	White	0412-0614

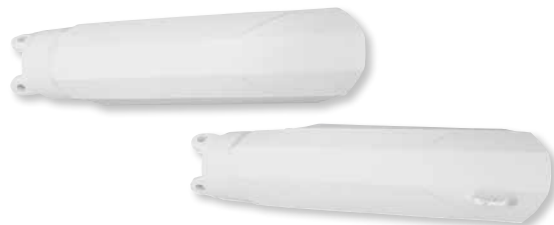

FULL ENGINE COVER KITS

- Guards the engine cases against scratches and impact damage
- Covers have a built-in O-ring ensures that trash and dust will not come in contact with the protected area
- Developed to use OEM bolts for an improved resistance
- Clutch cover, ignition cover and water pump covers included
- Easy installation and perfect fit to the covers; no need to disassemble the covers
- Hard shell in hard resistant PA6 polyamide material
- Slim design to minimize interference with the rider's boots
- Resistance to high continuous temperature
- Periodical cleaning and removal advised
- Compatible only with stock covers



FITS MODEL	PART #	FITS MODEL	PART #
HUSQVARNA		KTM (CONT)	
TC 250 23-25	0506-2295	SX-F 250/350 23-25	0506-2117
FC 250/350 23-25	0506-2117	SX-F 450 23-25	0506-2118
FC 450 23-25	0506-2118	EXC 250/300 24-25	0506-2294
TE 250/300 24-25	0506-2294	YAMAHA	
KTM		YZ 450F 23-25, YZ 450FX 24-25, WR 450F 24-25	0506-2121
SX 250 23-25	0506-2295		



0505-2482



0505-2481

EXHAUST

LUGGAGE

BIKE STANDS & ACCESSORIES

HANDLEBARS & HAND CONTROLS

FOOTPEGS & FOOT CONTROLS

BODY

GRAPHICS & SEATS

SPROCKETS

CHAINS

BRAKES

WHEELS & ACCESSORIES

SUSPENSION

ELECTRICAL & GAUGES

LIGHTING

ENGINE

FUEL/AIR SYSTEMS

HARDWARE & MERCHANDISING

FRAME GUARDS

- Slim protection; doesn't interfere with rider's boots
- Abrasion and impact resistant
- Protects the frame from roost, rocks and rider's boots

FITS MODEL	COLOR	PART #
HUSQVARNA		
TC/FC 23-25	Black	0505-2482
TE/FE 24-25	Black	0505-2482
KTM		
SX/SX-F 23-25	Orange	0505-2481
	Black	0505-2480

FITS MODEL	COLOR	PART #
KTM (CONT)		
EXC/EXC-F 23-25	Orange	0505-2481
	Black	0505-2480

CLUTCH COVER PROTECTORS

- Tough, polyamide construction is abrasion and impact resistant
- Optimum protection against rocks and debris
- No need to disassemble the clutch cover for installation
- Slim design minimizes interference with rider's boots
- Works with stock clutch covers only
- Built in rubber O-ring to prevent vibration
- All mounting hardware included
- See pages 396-397 of the 2024 Parts Europe Offroad catalog for additional clutch cover applications

FITS MODEL	COLOR	PART #
HONDA		
CRF 250R 18-25, CRF 250RX 19-25	Gray	0506-1722
CRF 450R/RX 17-25	Gray	0506-1723
HUSQVARNA		
FE 250/350 17-18	Gray	0506-1724
KTM		
SX-F 250/350 16-22	Gray	0506-1724

FITS MODEL	COLOR	PART #
KTM (CONT)		
EXC-F 250/350 17-23	Gray	0506-1724
SHERCO		
SE-R 250/300 14-25	Gray	0506-1728
SE 250/300 Factory 20-25	Gray	0506-1728
SEF-R 250/300 14-23	Gray	0506-1729
SEF-R 250/300 Factory 20-23	Gray	0506-1729

0506-1722



IGNITION COVER PROTECTORS

- Tough polyamide construction
- Perfect fit to ignition cover
- Provides optimum protection against rock impacts
- No need to disassemble the ignition cover for installation
- Built-in O-ring to prevent vibrations
- Free clearance to the oil filter cover and cap
- All mounting hardware included
- Slim design to minimize interference with rider's boots
- See page 397 of the 2024 Parts Europe Offroad catalog for additional ignition cover applications

FITS MODEL	COLOR	PART #
GASGAS		
MC 250 24-25	Black	0506-2297
EC 250/300 24-25	Black	0506-2296
HONDA		
CRF 250R 18-25, CRF 250RX 19-25	Gray	0506-1734
CRF 450R 17-20	Gray	0506-1735
HUSQVARNA		
TC 250 23-25	Black	0506-2297
FC 450 23-24	Black	0506-2116
TE 250/300 24-25	Black	0506-2296
FE 250/350 17-23	Gray	0506-1740

FITS MODEL	COLOR	PART #
HUSQVARNA (CONT)		
FE 450/501 17-23	Gray	0506-1741
KTM		
SX 250/300 23-25	Black	0506-2297
SX-F 250/350 23-24	Black	0506-2116
EXC 250/350 24-25	Black	0506-2296
EXC-F 250/350 17-23	Gray	0506-1740
EXC-F 450/500 17-23	Gray	0506-1741
SHERCO		
SE 250/300 14-24	Gray	0506-1742
SE-R 250/300 13-24	Gray	0506-1743

0506-2297





EXHAUST

LUGGAGE

BIKE STANDS & ACCESSORIES

HANDLEBARS & HAND CONTROLS

FOOTPEGS & FOOT CONTROLS

BODY

GRAPHICS & SEATS

SPROCKETS

CHAINS

BRAKES

WHEELS & ACCESSORIES

SUSPENSION

ELECTRICAL & GAUGES

LIGHTING

ENGINE

FUEL/AIR SYSTEMS

HARDWARE & MERCHANDISING

REPLACEMENT PLASTIC FOR HONDA

- Color-matched to OEM or in optional works colors
- Injection-molded plastic for precise fit and finish
- Five-piece replica kits include front fender, rear fender, radiator scoops, side panels and Stadium number plate

• For the full line of replacement plastic for Honda see pages 398-401 of the 2024 Parts Europe Offroad catalog



1403-4141

FIVE-PIECE REPLICA KITS

FITS MODEL	COLOR	PART #
CRF 250R/450R 25	Red	1403-4141
	Red/black	1403-4138



1403-4139

FITS MODEL	COLOR	PART #
CRF 250R/450R 25 (CONT)	White	1403-4140
	Black	1403-4139

STADIUM NUMBER PLATES

FITS MODEL	COLOR	PART #
CRF 250R/450R 25	Red	0520-4123
	White	0520-4122

FITS MODEL	COLOR	PART #
CRF 250R/450R 25 (CONT)	Black	0520-4121

REPLACEMENT PLASTIC FOR KAWASAKI

- Color-matched to OEM or in optional works colors
- Injection-molded plastic for precise fit and finish
- Five-piece replica kits include front fender, rear fender, radiator scoops, side panels and Stadium number plate

• For the full line of replacement plastic for Kawasaki see pages 404-405 of the 2024 Parts Europe Offroad catalog

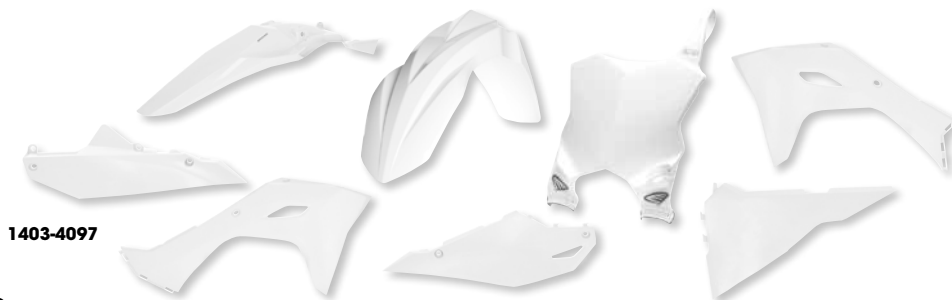

1403-4097

FIVE-PIECE REPLICA KITS

FITS MODEL	COLOR	PART #
KX 250 25, KX 450 24-25	White	1403-4097

FITS MODEL	COLOR	PART #
KX 250 25, KX 450 24-25 (CONT)	Black	1403-4096



1403-4090

PERFORMANCE FRONT FENDERS

FITS MODEL	COLOR	PART #
KX 250F 13-16, KX 450F 13-15	Black	1403-1049

REPLICA RADIATOR SHROUDS

FITS MODEL	COLOR	PART #
KX 250 25, KX 450 24-25	White	1403-4093
	Black	1403-4092

AIRBOX COVERS

FITS MODEL	COLOR	PART #
KX 250 25, KX 450 24-25	White	0520-4057
	Black	0520-4056

REPLICA FRONT AND REAR FENDERS

FITS MODEL	COLOR	PART #
FRONT		
KX 250 25, KX 450 24-25	Black	1403-4090
REAR		
KX 250 25, KX 450 24-25	White	1403-4095
	Black	1403-4094

SIDE NUMBER PANELS

FITS MODEL	COLOR	PART #
KX 250 25, KX 450 24-25	White	0520-4055
	Black	0520-4054



REPLACEMENT PLASTIC FOR KTM

- Color-matched to OEM or in optional works colors
- Injection-molded plastic for precise fit and finish

• For the full line of replacement plastics for KTM see pages 406-407 of the 2024 Parts Europe Offroad catalog



0520-4029



0520-4028

STADIUM NUMBER PLATES

FITS MODEL

SX 125/250, SX-F 250-450 23-25, SX-F 250-450 F.E. 22-25

COLOR

Orange
White
Black

PART

0520-4029
0520-4030
0520-4028

REPLACEMENT PLASTIC FOR YAMAHA

- Color-matched to OEM or in optional works colors
- Injection-molded plastic for precise fit and finish
- For the full line of replacement plastic for Yamaha see pages 410-413 of the 2024 Parts Europe Offroad catalog

CYCRALITE FRONT FENDERS

FITS MODEL

YZ 250F 24-25, YZ 450F 23-25, WR 450F 24-25

COLOR

YZ blue
White
Black

PART

0520-3933
1403-3984
1403-3983



1403-3981



0520-4053

POWERFLOW REAR FENDERS

FITS MODEL

YZ250F 24-25, YZ450F 23-25

COLOR

Blue
White
Black

PART

1403-3982
1403-3981
1403-3980

AIRBOX COVERS

FITS MODEL

YZ 250F 24-25, YZ 450F 23-25, WR 450F 24-25

COLOR

Blue
White
White
Black
Black

PART

0520-4053¹
0520-3940
0520-4052¹
0520-3939
0520-4051¹

¹ Vented design.

POWERFLOW INTAKE RADIATOR SHROUDS

- Cycra bypass airflow technology, or "powerflow", dramatically reduces radiator, fuel tank and engine head temperatures to prolong engine life
- Bypass scoop manipulates air velocity using a narrowing "powerflow channel" to accelerate airflow past the radiator

- Cools bike by maximizing radiator efficiency
- Injection-molded, precise fit and high gloss finish

POWERFLOW INTAKE RADIATOR SHROUDS

FITS MODEL

YZ250F 24-25, YZ450F 23-25, WR450F 24-25

COLOR

Blue
White
Black

PART

0520-3936
0520-3935
0520-3934

EXHAUST

LUGGAGE

BIKE STANDS & ACCESSORIES

HANDLEBARS & HAND CONTROLS

FOOTPEGS & FOOT CONTROLS

BODY

GRAPHICS & SEATS

SPROCKETS

CHAINS

BRAKES

WHEELS & ACCESSORIES

SUSPENSION

ELECTRICAL & GAUGES

LIGHTING

ENGINE

FUEL/AIR SYSTEMS

HARDWARE & MERCHANDISING



EXHAUST

LUGGAGE

BIKE STANDS & ACCESSORIES

HANDLEBARS & HAND CONTROLS

FOOTPEGS & FOOT CONTROLS

BODY

GRAPHICS & SEATS

SPROCKETS

CHAINS

BRAKES

WHEELS & ACCESSORIES

SUSPENSION

ELECTRICAL & GAUGES

LIGHTING

ENGINE

FUEL/AIR SYSTEMS

HARDWARE & MERCHANDISING



CARBON FIBER SKID PLATES BY E LINE

- Thick composite plates with many advantages over aluminum
- The use of antiballistic composite material provides a longer fatigue life and greater tensile strength than aluminum
- Composite plates are molded to the exact shape desired, making for a closer fit and more protective plate
- Composite plates absorb vibration and do not amplify sounds like aluminum plates do
- When hit hard, aluminum permanently deforms, bending frame tubes and slicing into water pumps
- Composite plates will bounce back from hard hits and look great long after aluminum plates give up
- Skid plates protect the side engine cases and the water pump in addition to the frame and the center case
- Designed with a high front to keep mud from building up on the engine
- Mounting hardware included

• See page 416 of the 2024 Parts Europe Offroad catalog for Moose Racing's full line of carbon fiber skid plates by E Line

FITS MODEL	PART #	FITS MODEL	PART #	FITS MODEL	PART #
GASGAS		HUSQVARNA (CONT)		SHERCO	
MC 125 24-25	0506-2201	TE 250/300 25	0506-2158	SEF 250/300 Factory 17-24	0506-2204
MC 250F 24-25	0506-2158	KTM		YAMAHA	
EC 250 24-25	0506-2158	SX 125 23-25	0506-2201	YZ 250F 24-25	0506-2202
HUSQVARNA		SX 250 23-25	0506-2158	YZ 450F 23-25	0506-2202
TC 125 23-25	0506-2201	EXC 250/300 24-25	0506-2158	YZ 250FX 20-24, YZ 450FX 19-23	0506-2203
TC 250 23-25	0506-2158				

ALUMINUM SKID PLATE

- Protects vital engine parts and cases from rocks and debris
- Clear anodized for corrosion protection and good looks
- Skid plates made from 4,8 mm (³/₁₆"") 5052 H-32 aluminum (some plates use 4,1 mm (0,160"))
- Smooth underside won't snag when crossing logs
- Oil drain hole on all required models
- Heat-treated chromoly steel clamps keep plates mounted securely
- All mounting hardware included
- Replacement clamps available

• See pages 417-418 of the 2024 Parts Europe Offroad catalog for Moose Racing's complete line of aluminum skid plates



FITS MODEL	PART #
YAMAHA	
YZ 250F 01-05	M251



PRO LG SKID PLATES

- Made from high-density polyethylene construction
- 8 mm thick HDPE offers more protection than the standard Pro Skid Plate
- Full linkage protection
- 40% lighter than aluminum and no rattling
- Mounting hardware and installation instructions included
- See page 419 of the 2024 Parts Europe Offroad catalog for Moose Racing's complete line of Pro LG skid plates

FITS MODEL	PART #	FITS MODEL	PART #	FITS MODEL	PART #
APRILIA		SUZUKI		YAMAHA (CONT)	
Tuareg 660 20-24	0506-2283	V-Strom 800DE 22-24	0506-2284	YZ 250F 24-25	0506-2287
BETA		YAMAHA			
Xtrainer 250/300 16-24	0506-2306	YZ 250 05-25	0506-1218		



0506-2284



PRO SKID PLATES

- Made from a flexible high-density polyethylene construction
- HDPE is an excellent material: a technical plastic that offers many characteristics to protect your bike
- 6 mm thick for maximum protection of the frame and cases
- Goes through a thermoforming process and is then welded
- 40% lighter than 4 mm aluminum
- No more vibrating or rattling
- Mounting hardware and installation instructions included
- See page 420 of the 2024 Parts Europe Offroad catalog for Moose Racing's complete line of Pro skid plates

FITS MODEL	PART #	FITS MODEL	PART #	FITS MODEL	PART #
BETA		GASGAS (CONT)		KTM	
RR 4T 350 23-24	0506-2282	MC 125 24-25	0506-2152	SX 125 23-25	0506-2152
RR 4T 390 23-24	0506-2282	HUSQVARNA		YAMAHA	
RR 4T 430 23-24	0506-2282	TC 125 23-25	0506-2152	YZ 125 24-25	0506-2280
RR 4T 480 23-24	0506-2282	TE 150 24-25	0506-2152	YZ 250F 24	0506-2286
GASGAS		KAWASAKI			
MC 65 24-25	0506-2307	KX 450 24	0506-2285		
MC 85 24-25	0506-2281				



FULL ARMOR SKID PLATES

- High-quality injection-molded for precise fit and finish
- Provides full coverage
- Billet alloy front bracket and direct-mount rear
- Easy installation with race performance
- Reinforced with high impact-resistant materials
- Full Armor skid plates offer extended full-coverage designs
- For the full line of Full Armor skid plates see pages 422-423 of the 2024 Parts Europe Offroad catalog

FITS MODEL	COLOR	PART #	FITS MODEL	COLOR	PART #	FITS MODEL	COLOR	PART #
KAWASAKI			YAMAHA			YAMAHA (CONT)		
KX 450 24-25	Black	0506-2274	YZ 250F 24-25	Black	0506-2345	YZ 450F 23-25	Black	0506-2144
				Blue	0506-2346		Blue	0506-2145



0506-2274



0506-2346

- EXHAUST
- LUGGAGE
- BIKE STANDS & ACCESSORIES
- HANDLEBARS & HAND CONTROLS
- FOOTPEGS & FOOT CONTROLS
- BODY**
- GRAPHICS & SEATS
- SPROCKETS
- CHAINS
- BRAKES
- WHEELS & ACCESSORIES
- SUSPENSION
- ELECTRICAL & GAUGES
- LIGHTING
- ENGINE
- FUEL/AIR SYSTEMS
- HARDWARE & MERCHANDISING



EXHAUST

LUGGAGE

BIKE STANDS & ACCESSORIES

HANDLEBARS & HAND CONTROLS

FOOTPEGS & FOOT CONTROLS

BODY

GRAPHICS & SEATS

SPROCKETS

CHAINS

BRAKES

WHEELS & ACCESSORIES

SUSPENSION

ELECTRICAL & GAUGES

LIGHTING

ENGINE

FUEL/AIR SYSTEMS

HARDWARE & MERCHANDISING

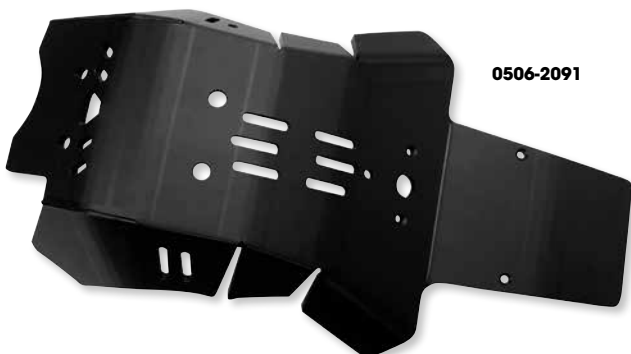

0506-2091



0506-2078

XTREM SKID PLATES

- Made for an extreme use
- Offers the maximum of protection needed for your bike
- Frame entirely covered, linkage and engine cases protection and provides water pump protection on the 4-stroke models

- Made of 8 mm HDPE plastic (2 mm more than the MX/SX range), it is a "one bloc" made and welded only in the inside for better resistance
- No vibrations, no deformation, lightweight and durable, the polyethylene is the perfect option compared to alloy or carbon

FITS MODEL	COLOR	PART #
BETA		
RR 2T 125/200 23-25	Black	0506-2091
RR 2T/Racing 2T 250/300 24	Black	0506-2334
	Red	0506-2335
RR 4T/Racing 350-480 24	Black	0506-2336
	Red	0506-2337
RR 4T 350 /390/480/500 23	Black	0506-2089
Xtrainer 250/300 23	Black	0506-2087
Xtrainer 300 15-22	Black	0506-2192
GASGAS		
MC/EC 125 25	Black	0506-2081
MC 250 24-25	Black	0506-2072
MC 250F 21-23	Black	0506-2064
MC 250F 24-25	Black	0506-2078
MC 350F 24-25	Black	0506-2078
MC 450F 21-23	Black	0506-2063
MC 450F/EC 500F 24-25	Black	0506-2075
EC 250 18-20	Black	0506-2191
EC 250/300 21-23	Black	0506-2060
EC 250/300 24-25	Black	0506-2072
EC 300 19-19	Black	0506-2191
EC 300 Ranger 19-20	Black	0506-2191
EC 250F 18-19	Black	0506-2191
EC 250F/350F 21-23	Black	0506-2065
EC 300F 18-19	Black	0506-2191

FITS MODEL	COLOR	PART #
HONDA		
CRF 250R/RX 22-23	Black	0506-2071
CRF 450R/RX 21-25	Black	0506-2062
CRF 450L 19-20	Black	0506-2196
HUSQVARNA		
TC 125 23-25	Black	0506-2081
TC 250/300 23-25	Black	0506-2072
FC 250/350 23-25	Black	0506-2078
	Blue	0506-2080
FC 450 16-18	Black	0506-2033
FC 450 23-25	Black	0506-2075
TE 150 20-23	Black	0506-2040
TE 150 24-25	Black	0506-2081
TE 250/300 20-22	Black	0506-2060
	Blue	0506-2061
TE 250/300 23	Black	0506-2060
	Blue	0506-2061
TE 250/300 24-25	Black	0506-2072
FE 250/350 24-25	Black	0506-2078
	Blue	0506-2080
FE 450/501 17-23	Black	0506-2033
FE 450/501 24-25	Black	0506-2075
KTM		
SX 125/150 17-22	Black	0506-2040
SX 125 23-25	Black	0506-2081

FITS MODEL	COLOR	PART #
KTM (CONT)		
SX 250/300 23-25	Black	0506-2072
SX-F 250/350 23-25	Black	0506-2078
SX-F 450 16-18	Black	0506-2033
SX-F 450 23-25	Black	0506-2075
EXC 250/300 24-25	Black	0506-2197
EXC-F 250/350 24-25	Black	0506-2198
EXC-F 450 17-23	Black	0506-2044
EXC-F 450/500 24-25	Black	0506-2199
RIEJU		
MR 300 (all) 21	Black	0506-2191
SHERCO		
SC/SE/SE-R 125 18-23	Black	0506-2193
	Blue	0506-2194
SC 250/300 Factory, SE 250/300 Racing/Factory 14-23	Blue	0506-2034
SCF 450/500 19-20, SEF 450/500 19-23, SEF-R 450/500 19-21	Blue	0506-2195
YAMAHA		
YZ 250 05-25	Black	0506-2039



PLASTIC SKID PLATES

- The plastic HDPE skid plate is dedicated to motocross, supercross and classic enduro use
- Made from 6 mm thick polyethylene, it covers the underside of the frame, protects the lower engine and crankcases from projections
- Unlike aluminum, HDPE absorbs impacts, does not undergo deformation, does not generate vibrations and is 40% lighter

FITS MODEL	COLOR	PART #
FANTIC		
XX/XE 125 20-24	Black	0506-2189
GASGAS		
MC 65 21-23	Black	0506-1999

FITS MODEL	COLOR	PART #
GASGAS (CONT)		
MC 65 24-25	Black	0506-2302
	Blue	0506-2303
MC 85 21-23	Black	0506-1991

FITS MODEL	COLOR	PART #
GASGAS (CONT)		
MC 300 22-23	Black	0506-1995
MC 250F 21-23	Black	0506-2005
MC/EC 250F/350F 24-25	Black	0506-2013



PLASTIC SKID PLATES (CONT)

FITS MODEL	COLOR	PART #
GASGAS (CONT)		
MC 450F 21-24	Black	0506-2003
HONDA		
CRF 250R 21-23	Black	0506-2001
CRF 450R 21-25	Black	0506-2001
CRF 300L 21-24	Black	0506-2006
HUSQVARNA		
TC 65 18-23	Black	0506-1999
TC 65 24-25	Black	0506-2302
	Blue	0506-2303
TC 85 18-23	Black	0506-1991
TC 250 19-22	Black	0506-1995
FC 250/350 23-25	Black	0506-2013
TE 250/300 17-23	Black	0506-1988
FE 250/350 24-25	Black	0506-2013

FITS MODEL	COLOR	PART #
KAWASAKI		
KX 250 21-24	Black	0506-2002
KX 450 19-23	Black	0506-1996
KX 450 24-25	Black	0506-2300
KTM		
SX 65 18-23	Black	0506-1999
SX 65 24-25	Black	0506-2302
	Blue	0506-2303
	Orange	0506-2304
SX 85 18-24	Black	0506-1991
SX 250 19-22	Black	0506-1995
SX-F 250/350 23-25	Black	0506-2013
EXC 250/300 17-23	Black	0506-1988
EXC-F 250/350 17-23	Black	0506-1989
EXC-F 250/350 24-25	Black	0506-2013

FITS MODEL	COLOR	PART #
KTM (CONT)		
EXC-F 450/500 17-23	Black	0506-1990
TRIUMPH		
TF 250-X 24-25	Black	0506-2339
YAMAHA		
YZ 65 18-25	Black	0506-1997
YZ 85 19-23	Black	0506-1998
YZ 125 05-25	Black	0506-2189
YZ 250 05-25	Black	0506-2190
YZ 250F 19-23	Black	0506-1993
YZ 250F 24-25	Black	0506-2301

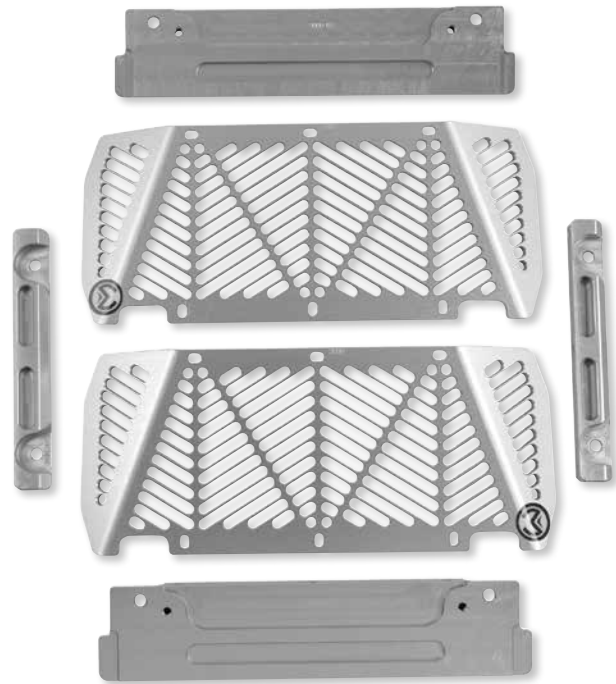

BILLET RADIATOR GUARD FOR KAWASAKI KLX 400 03-04, SUZUKI DR-Z 400 00-24

- New billet design provides excellent side and front impact protection
- Protects the radiator from collisions or crashes
- Clean design with maximum airflow
- Easy Installation; install both sides in less than 4 minutes
- Will not pair with radiator braces
- See pages 425-426 of the 2024 Parts Europe Offroad catalogue for additional billet radiator guard applications

DESCRIPTION	PART #
Billet radiator guard	1901-0952



RADIATOR SLEEVES

- Fits over the radiator louvers to prevent dirt, sand and mud from clogging the radiator
- Made from nylon-coated glass yarn material
- Easy installation – simply remove the louvers, slide on the sleeve and re-install on the radiator
- For the full line of radiator sleeves see page 428 of the 2024 Parts Europe Offroad catalog



FITS MODEL	PART #	FITS MODEL	PART #	FITS MODEL	PART #
GASGAS		KAWASAKI		TRIUMPH	
MC 65 24-25	1904-0322	KX 250 25, KX 450 24-25	1904-0308	TF 250-X 24-25	1904-0323
HUSQVARNA		KTM			
TC 65 24-25	1904-0322	SX 65 24-25	1904-0322		

- EXHAUST
- LUGGAGE
- BIKE STANDS & ACCESSORIES
- HANDLEBARS & HAND CONTROLS
- FOOTPEGS & FOOT CONTROLS
- BODY**
- GRAPHICS & SEATS
- SPROCKETS
- CHAINS
- BRAKES
- WHEELS & ACCESSORIES
- SUSPENSION
- ELECTRICAL & GAUGES
- LIGHTING
- ENGINE
- FUEL/AIR SYSTEMS
- HARDWARE & MERCHANDISING



EXHAUST

LUGGAGE

BIKE STANDS & ACCESSORIES

HANDLEBARS & HAND CONTROLS

FOOTPEGS & FOOT CONTROLS

BODY

GRAPHICS & SEATS

SPROCKETS

CHAINS

BRAKES

WHEELS & ACCESSORIES

SUSPENSION

ELECTRICAL & GAUGES

LIGHTING

ENGINE

FUEL/AIR SYSTEMS

HARDWARE & MERCHANDISING

XTREM RADIATOR GUARDS

- Especially made for Hard Enduro and developed with our pro riders in all conditions, these radiator guards offer a maximum of protection by wrapping the radiators and being against the central part of the frame to provide a maximum of rigidity and limit deformation
- Designed from 6 mm thick HDPE plastic with removable protection grids
- Provide more resistance to impacts, do not limit airflow and remove quickly to allow perfect radiator cleaning
- 4 mm thick aluminum base with spacers offering a strong rigidity



1901-0931

FITS MODEL	PART #
BETA	
RR 2T 125/200/250/300 20-23	1901-0931
RR 2T 125/200/250/300 24	1901-0953
RR 4T 350/390/430/480/500 20-23	1901-0932

FITS MODEL	PART #
BETA (CONT)	
RR 4T 350/390/430/480/500 24	1901-0954
SHERCO	
SE/SC 250/300 Factory/Racing 20-24	1901-0930

RADIATOR BRACES

- Cut in an aluminum plate 4 mm thick and light
- The protections are mounted at three points, two at the front and one at the rear
- This design laterally protects your radiators in the event of slow drops but also prevents them from rolling back during high-speed impacts
- The protection is provided for both sides with all the screws necessary for assembly

NOTE: Our radiator reinforcement will allow you to minimize damage. Radiator deformations may occur despite protection.



1901-0925

FITS MODEL	COLOR	PART #
BETA		
RR/Racing 2T 125/200/250/300 20-23	Red	1901-0942
RR/4T Racing 350/390/430/480 20-22	Red	1901-0943
RR-S 500 20-22	Red	1901-0943
Xtrainer 250/300 23-25	Red spacers	1901-0928
Xtrainer 300 16-22	Black spacers	1901-0925
FANTIC		
XEF 250 21-24	Alloy	1901-0945
GASGAS		
MC 125/250/250F/350F/450F 24-25	Black spacers	1901-0950
EC 250/300 24-25	Black spacers	1901-0950
EC 250F/350F/450F/500F 24-25	Black spacers	1901-0950
HONDA		
CRF 250R 22-24, CRF 450R 21-24	Red	1901-0927
HUSQVARNA		
TC 125/250 23-24	Black spacers	1901-0950
FC 250/350/450 23-24	Black spacers	1901-0950
TE 150/250/300 24	Black spacers	1901-0950

FITS MODEL	COLOR	PART #
HUSQVARNA (CONT)		
FE 250/350/450/501 24-25	Black spacers	1901-0950
KTM		
SX 125/250/300 23-24	Black spacers	1901-0950
SX-F 250/350/450 23-24	Black spacers	1901-0950
EXC 150/250/300 24	Black spacers	1901-0950
EXC-F 250/350/450/500 24	Black spacers	1901-0950
SHERCO		
SCF 250/300 Factory 19-20, SEF 250/300 Factory 19-23, SEF-R 250/300 16-22	Alloy	1901-0938
SEF 250/300 24-25	Black spacers	1901-0951
YAMAHA		
YZ 125 02-21	Blue spacers	1901-0946
YZ 250 05-21, WR 250 16-21	Blue spacers	1901-0947
YZ 250F 19-23, YZ 450F 18-22	Blue spacers	1901-0926
YZ 250F 24-25, YZ 450F 23-25	Alloy	1901-0949
WR 250F 15-19, WR 450F 16-20	Blue spacers	1901-0939
WR 250F 21-24, WR 450F 19-25	Alloy	1901-0945

FUEL TANK

FOR YAMAHA YZ 125 22-25, YZ 250 23-25

- Replica of the OEM fuel tank
- Has a capacity of 7,3 L (1,9 gal)
- Weighs approximately 1,58 kg (3,48 lbs)
- Accepts stock filler cap
- Includes fuel hose
- Black

DESCRIPTION	PART #
Fuel tank	0701-1017





0701-1012



0701-1021



0701-1005

EXHAUST

LUGGAGE

BIKE STANDS & ACCESSORIES

HANDLEBARS & HAND CONTROLS

FOOTPEGS & FOOT CONTROLS

BODY

GRAPHICS & SEATS

SPROCKETS

CHAINS

BRAKES

WHEELS & ACCESSORIES

SUSPENSION

ELECTRICAL & GAUGES

LIGHTING

ENGINE

FUEL/AIR SYSTEMS

HARDWARE & MERCHANDISING



LARGE-CAPACITY GAS TANKS

- High-density polyethylene gas tanks offer maximum fuel-carrying capacity
- All tank colors match OEM colors
- All necessary hardware included (tank decals not included)
- See page 432 of the 2024 Parts Europe Offroad catalog for the complete line of IMS large-capacity gas tanks

FITS MODEL	COLOR	LITER/US GAL	PART #
GASGAS			
MC 125/250/250F/350F/450F 24	Black	12,3/3,25	0701-1012
	Off-white	12,3/3,25	0701-1013
EC 250/250F/300/350F/450F 24	Black	12,3/3,25	0701-1012
	Off-white	12,3/3,25	0701-1013
HONDA			
CRF 300L 21-24	Black	9,46/2,5	0701-1022
	Natural	9,46/2,5	0701-1023
HUSQVARNA			
TC 125/250 23-25	Black	10,6/2,8	0701-1002
	Natural	10,6/2,8	0701-1003
FC 250/350/450 23-25	Black	10,6/2,8	0701-1002
	Natural	10,6/2,8	0701-1003
TE 250 20	Black	17/4,5	0701-1020
TE 300 20	Black	17/4,5	0701-1020
FC 450 Rockstar Edition 22-24	Black	10,6/2,8	0701-1002
	Natural	10,6/2,8	0701-1003
FE 450 23	Natural	17/4,5	0701-1021
FE 450 Heritage 23	Natural	17/4,5	0701-1021



0701-1010

FITS MODEL	COLOR	LITER/US GAL	PART #
KTM			
SX 125/250 23-25	Black	10,6/2,8	0701-1004
	Natural	10,6/2,8	0701-1005
SX-F 250/350/450 23-25	Black	10,6/2,8	0701-1004
	Natural	10,6/2,8	0701-1005
EXC-F 250/350/450/500 24-25	Black	10,6/2,8	0701-1004
	Natural	10,6/2,8	0701-1005
YAMAHA			
WR 450F 24-25	Black	10,6/2,8	0701-1010
	Off-white	10,6/2,8	0701-1011
YZ 125/250 22-25	Black	12,1/3,2	0701-1006
	Off-white	12,1/3,2	0701-1007
YZ 250F 24-25	Black	10,6/2,8	0701-1008
	Off-white	10,6/2,8	0701-1009
YZ 450F 23-25	Black	10,6/2,8	0701-1008
	Off-white	10,6/2,8	0701-1009



PRESTON PETTY MX FENDERS

- Includes oval Preston Petty Product decal on the fender and an extra in the box
- Each fender will have the same original wording and logo as Preston had and his "Preston Petty Product" oval logo
- See page 439 of the 2024 Parts Europe Offroad catalog for Polisport's complete line of Preston Petty MX fenders

DESCRIPTION	COLOR	PART #
Front fender	Black	1403-2624



1403-2624



1403-2640

DESCRIPTION	COLOR	PART #
Rear fender	Black	1403-2640



SCREW REPAIR SET

- Universal bolt set for repairing cracked fairings
- Set contains 12 cross head screws and 6 connector links
- This prevents further cracking in the bodywork
- Can also be used to replace missing or lost bolts



DESCRIPTION	PART #
Universal screw repair set	2401-1640

EXHAUST

LUGGAGE

BIKE STANDS & ACCESSORIES

HANDLEBARS & HAND CONTROLS

FOOTPEGS & FOOT CONTROLS

BODY

GRAPHICS & SEATS

SPROCKETS

CHAINS

BRAKES

WHEELS & ACCESSORIES

SUSPENSION

ELECTRICAL & GAUGES

LIGHTING

ENGINE

FUEL/AIR SYSTEMS

HARDWARE & MERCHANDISING



4302-7315



DREAM 5 GRAPHIC KITS AND FORKGUARD STICKERS FOR HONDA

- 0,5 mm thick material with a strong sticker designed for offroad use
- Silk-screen printing with resistant and shiny inks
- Kits include: radiator shrouds pair, front fender and rear fender

FITS MODEL	PART #	FITS MODEL	PART #	FITS MODEL	PART #
GRAPHIC KITS		GRAPHIC KITS (CONT)		GRAPHIC KITS (CONT)	
CR 80 96-02	4302-7301	CRF 250 18-21	4302-7313	CRF 450 25	4302-7315
CR 85 03-07	4302-7302	CRF 250 22-24	4302-7314	CRF 450X 04-16	4302-7311
CR 125/250 93-97	4302-7309	CRF 250 25	4302-7315	CRF 450X 17-23	4302-7313
CR 125/250 98-99	4302-7308	CRF 450 02-04	4302-7306	FORKGUARD STICKERS	
CR 125/250 00-01	4302-7307	CRF 450 05-08	4302-7303	CR 125/250 91-03, CRF 450 02-03	4302-7316
CR 125/250 02-07	4302-7305	CRF 450 09-12	4302-7310	CR 125/250 04-07, CRF 250/450 04-08	4302-7317
CRF 250 04-09	4302-7304	CRF 450 13-16	4302-7312	CRF 250/450 09-18	4302-7318
CRF 250 10-13	4302-7310	CRF 450 17-20	4302-7313	CRF 250/450 19-25	4302-7319
CRF 250 14-17	4302-7312	CRF 450 21-24	4302-7314		

0821-3608



REPLICA TEAM GRAPHIC KITS, AND SEAT COVERS FOR HONDA

- Graphic kit includes: radiator shrouds, front fender, rear fender, airbox, fork protectors and swingarm graphics (number plate backgrounds not included)

REPLICA SEAT COVERS FOR HONDA

- Contours perfectly to the shape of the OEM seat
- Non-slip material for extra control
- Water-resistant
- See page 448 of the 2024 Parts Europe Offroad catalog for the complete line of Blackbird Replica Team graphics kits for Honda

FITS MODEL	GRAPHIC KIT PART #	SEAT COVER PART #	FITS MODEL	GRAPHIC KIT PART #	SEAT COVER PART #
TEAM HRC 2024			TEAM HRC 2024 (CONT)		
CR 125/250 02-07 (Polisport restyle)	-	0821-3608	CRF 450 02-04	-	0821-3608
CR 125/250 02-07	4302-7290	0821-3608	CRF 450 09-12	4302-7291	-
CRF 250 04-09	4302-7289	0821-3609	CRF 450 13-16	-	0821-3610
CRF 250 10-13	4302-7291	-	CRF 450 17-20	4302-7292	0821-3611
CRF 250 14-17	-	0821-3610	CRF 450 21-24	4302-7293	0821-3612
CRF 250 18-21	4302-7292	0821-3611	CRF 450 25	4302-7294	-
CRF 250 22-24	4302-7293	0821-3612	CRF 450X 04-16	-	0821-3609
CRF 250 25	4302-7294	-			



DREAM 5 GRAPHIC KITS AND FORKGUARD STICKERS FOR HUSQVARNA

- 0,5 mm thick material with a strong sticker designed for offroad use
- Silk-screen printing with resistant and shiny inks
- Kits include: radiator shrouds pair, front fender and rear fender

FITS MODEL	PART #	FITS MODEL	PART #	FITS MODEL	PART #
GRAPHIC KITS		GRAPHIC KITS (CONT)		GRAPHIC KITS (CONT)	
TC 85 14-17	4302-7361	TC/FC 19-22, TE/FE 20-23	4302-7363	CR/WR 06-08, WR 250 06-13, WR 300 09-13	4302-7357
TC 85 18-24	4302-7362	TC/FC 25	4302-7365		4302-7358¹
TC 85 25	4302-7364	CR/WR 09-13, TC/TE 250-310 08-13, TC/TE 450-510 08-10	4302-7356	FORKGUARD STICKERS	
TC/FC 14-15, TE/FE 14-16	4302-7359			TC/FC/TE/FE 14-15	4302-7366
TC/FC 16-18, TE/FE 17-19	4302-7360				

¹ Alternate design.



REPLICA TEAM GRAPHIC KITS FOR HUSQVARNA

- Graphic kit includes: radiator shrouds, front fender, rear fender, airbox, fork protectors and swingarm graphics (number plate backgrounds not included)
- See page 452 of the 2024 Parts Europe Offroad catalog for the complete line of Blackbird Replica Team graphic kits for Husqvarna

FITS MODEL	GRAPHIC KIT PART #	FITS MODEL	GRAPHIC KIT PART #	FITS MODEL	GRAPHIC KIT PART #
FACTORY		FACTORY (CONT)		FACTORY (CONT)	
TC/FC 16-18, TE/FE 17-19	4302-7296	TC/FC 19-22, TE/FE 20-23	4302-7297	TC/FC 23-24, TE/FE 24-25	4302-7298

EXHAUST

LUGGAGE

BIKE STANDS & ACCESSORIES

HANDLEBARS & HAND CONTROLS

FOOTPEGS & FOOT CONTROLS

BODY

GRAPHICS & SEATS

SPROCKETS

CHAINS

BRAKES

WHEELS & ACCESSORIES

SUSPENSION

ELECTRICAL & GAUGES

LIGHTING

ENGINE

FUEL/AIR SYSTEMS

HARDWARE & MERCHANDISING

EXHAUST

LUGGAGE

BIKE STANDS & ACCESSORIES

HANDLEBARS & HAND CONTROLS

FOOTPEGS & FOOT CONTROLS

BODY

GRAPHICS & SEATS

SPROCKETS

CHAINS

BRAKES

WHEELS & ACCESSORIES

SUSPENSION

ELECTRICAL & GAUGES

LIGHTING

ENGINE

FUEL/AIR SYSTEMS

HARDWARE & MERCHANDISING

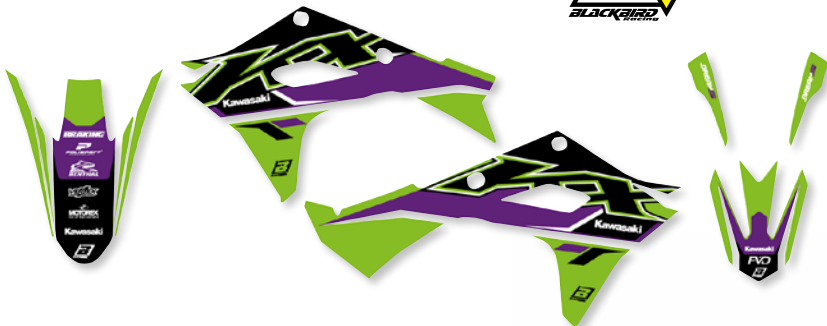

4302-7330



DREAM 5 GRAPHIC KITS AND FORKGUARD STICKERS FOR KAWASAKI

- 0,5 mm thick material with a strong sticker designed for offroad use
- Silk-screen printing with resistant and shiny inks
- Kits include: radiator shrouds pair, front fender and rear fender

FITS MODEL	PART #
GRAPHIC KITS	
KX 85 01-13	4302-7320
KX 85 14-21	4302-7326
KX 85 22-23	4302-7329
KX 125/250 94-98	4302-7323
KX 125/250 99-02	4302-7322
KX 250F 04-05	4302-7321

FITS MODEL	PART #
GRAPHIC KITS (CONT)	
KX 250F 06-08	4302-7324
KX 250F 13-16	4302-7325
KX 250F 17-20	4302-7327
KX 250 21-24, KX 450 19-23	4302-7328
KX 250 25, KX 450 24-25	4302-7330

FITS MODEL	PART #
FORKGUARD STICKERS	
KX 125/250 94-03	4302-7331
KX 250F 09-12, KX 450F 09-11	4302-7332



4302-7351



DREAM 5 GRAPHIC KITS AND FORKGUARD STICKERS FOR KTM

- 0,5 mm thick material with a strong sticker designed for offroad use
- Silk-screen printing with resistant and shiny inks
- Kits include: radiator shrouds pair, front fender and rear fender

FITS MODEL	PART #
GRAPHIC KITS	
SX 50 16-23, E 20-23	4302-7344
SX 50 24-25	4302-7349
SX 65 16-23	4302-7345
SX 65 24-25	4302-7350
SX 85 06-12	4302-7337
SX 85 13-17	4302-7341
SX 85 18-23	4302-7346
SX 85 25	4302-7351
SX/EXC 98-00	4302-7338
SX 01-04, EXC 03-04	4302-7334

FITS MODEL	PART #
GRAPHIC KITS (CONT)	
SX/SX-F 05-06	4302-7335
SX/SX-F 07-10, EXC 08-11	4302-7336
SX/SX-F 11-12, EXC 12-13	4302-7339
SX/SX-F 13-15, EXC 14-16	4302-7340
SX/SX-F 16-18, EXC 17-19	4302-7343
SX/SX-F 19-22, EXC 20-23	4302-7347
SX/SX-F 23-24	4302-7348
EXC 01-02	4302-7333
Freeride 12-23	4302-7342

FITS MODEL	PART #
FORK GUARD STICKERS	
SX/SX-F/EXC/EXC-F 00-07	4302-7352
SX/SX-F 08-14, EXC/EXC-F 08-15	4302-7353
SX/SX-F 15-22, EXC/EXC-F 16-23	4302-7354
SX/SX-F 23-25, EXC/EXC-F 24-25	4302-7355



- EXHAUST
- LUGGAGE
- BIKE STANDS & ACCESSORIES
- HANDLEBARS & HAND CONTROLS
- FOOTPEGS & FOOT CONTROLS
- BODY

GRAPHICS & SEATS

- SPROCKETS
- CHAINS
- BRAKES

WHEELS & ACCESSORIES

- SUSPENSION
- ELECTRICAL & GAUGES

LIGHTING

ENGINE

FUEL/AIR SYSTEMS

HARDWARE & MERCHANDISING

REPLICA TEAM GRAPHIC KITS FOR KTM

- Graphic kits include: radiator shrouds, front fender, rear fender, airbox, fork protectors and swingarm graphics (number plate backgrounds not included)
- See page 458 of the 2024 Parts Europe Offroad catalog for the complete line of Blackbird Replica Team graphic kits for KTM

FITS MODEL	GRAPHIC KITS PART #	FITS MODEL	GRAPHIC KITS PART #	FITS MODEL	GRAPHIC KITS PART #
FACTORY 2023		FACTORY 2023 (CONT)		FACTORY 2023 (CONT)	
SX/SX-F 11-12, EXC 12-13	4302-7202	SX/SX-F 16-18, EXC 17-19	4302-7243	SX/SX-F 19-22, EXC 20-23	4302-7295



DREAM 5 GRAPHIC KITS AND FORKGUARD STICKERS FOR SUZUKI

- 0,5 mm thick material with a strong sticker designed for offroad use
- Silk-screen printing with resistant and shiny inks
- Kits include: radiator shrouds pair, front fender and rear fender

FITS MODEL	PART #	FITS MODEL	PART #	FITS MODEL	PART #
GRAPHIC KITS		GRAPHIC KITS (CONT)		FORKGUARD STICKERS	
RM 85 02-23	4302-7393	RM-Z 250 04-06	4302-7397	RM 125/250 99-03	4302-7401
RM 125-250 Polisport Restyle	4302-7400	RM-Z 250 07-09	4302-7396	RM 125/250 04-25, RM-Z 250 07-25, RM-Z 450 05-25	4302-7402
RM 125/250 96-00	4302-7394	RM-Z 250 10-18	4302-7399		
RM 125/250 01-23	4302-7398	DR-Z 400 00-23	4302-7395		



EXHAUST

LUGGAGE

BIKE STANDS & ACCESSORIES

HANDLEBARS & HAND CONTROLS

FOOTPEGS & FOOT CONTROLS

BODY

GRAPHICS & SEATS

SPROCKETS

CHAINS

BRAKES

WHEELS & ACCESSORIES

SUSPENSION

ELECTRICAL & GAUGES

LIGHTING

ENGINE

FUEL/AIR SYSTEMS

HARDWARE & MERCHANDISING



DREAM 5 GRAPHIC KITS AND FORKGUARD STICKERS FOR YAMAHA

- 0,5 mm thick material with a strong sticker designed for offroad use
- Silk-screen printing with resistant and shiny inks
- Kit includes: radiator shrouds pair, front fender and rear fender

FITS MODEL	PART #	FITS MODEL	PART #	FITS MODEL	PART #
GRAPHIC KITS		GRAPHIC KITS (CONT)		GRAPHIC KITS (CONT)	
PW 50 90-23	4302-7369	YZ 250F/400F/426F 98-02	4302-7375	WR 250F 07-14, WR 450F 07-11	4302-7377
YZ 65 19-25	4302-7385	YZ 250F/450F 03-05	4302-7373	WR 250F 15-19, WR 450F 16-18	4302-7383
YZ 85 02-14	4302-7367	YZ 250F/450F 06-09	4302-7371	FORKGUARD STICKERS	
YZ 85 15-21	4302-7382	YZ 250F/450F 10-13	4302-7379	YZ 125/250 96-04,	
YZ 85 22-25	4302-7387	YZ 250F 14-18, YZ 450F 14-17	4302-7380	YZ/WR 250F/400F/426F/450F 98-04	4302-7389
YZ 125/250 93-95	4302-7378	YZ 250F 19-23, YZ 450F 18-22	4302-7384	YZ 125/250 05-07, YZ 250F/450F 05-07,	
YZ 125/250 96-01	4302-7376	YZ 250F 24-25, YZ 450F 23-25	4302-7388	WR 250F/450F 05-09	4302-7390
YZ 125/250 02-14	4302-7374	WR 250F/400F/426F 98-02	4302-7370	YZ 125/250 08-14, YZ 250F/450F 08-09	4302-7391
YZ 125/250 15-21	4302-7381	WR 250F/450F 03-04	4302-7368	YZ 15-23, YZ 250F/450F 10-22	4302-7392
YZ 125/250 22-25	4302-7386	WR 250F/450F 05-06	4302-7372		

0821-3603



REPLICA TEAM GRAPHIC KIT, AND SEAT COVER FOR YAMAHA

- Graphic kit includes: radiator shrouds, front fender, rear fender, airbox, fork protectors and swingarm graphics (number plate backgrounds not included)

REPLICA SEAT COVER FOR YAMAHA

- Contours perfectly to the shape of the OEM seat
- Non-slip material for extra control
- Water-resistant
- See page 464 of the 2024 Parts Europe Offroad catalog for the complete line of Blackbird Replica Team graphic kits for Yamaha

FITS MODEL	GRAPHIC KIT PART #	SEAT COVER PART #	FITS MODEL	GRAPHIC KIT PART #	SEAT COVER PART #
YAMAHA FACTORY 50TH ANNIVERSARY			YAMAHA FACTORY 50TH ANNIVERSARY (CONT)		
YZ 250F 19-23	4302-7237	0821-3603	YZ 450F 18-22	4302-7237	0821-3603



EXHAUST

LUGGAGE

BIKE STANDS & ACCESSORIES

HANDLEBARS & HAND CONTROLS

FOOTPEGS & FOOT CONTROLS

BODY

GRAPHICS & SEATS

SPROCKETS

CHAINS

BRAKES

WHEELS & ACCESSORIES

SUSPENSION

ELECTRICAL & GAUGES

LIGHTING

ENGINE

FUEL/AIR SYSTEMS

HARDWARE & MERCHANDISING

DREAM 5 GRAPHIC KITS FOR BETA

- 0,5 mm thick material with a strong sticker designed for the offroad use
- Silk-screen printing with resistant and shiny inks
- Kits include: radiator shrouds pair, front fender and rear fender

FITS MODEL	PART #
BETA	
RR (all) 13-17	4302-7415
RR (all) 23-25	4302-7416



DREAM 5 GRAPHIC KITS AND FORKGUARD STICKERS FOR GASGAS

- 0,5 mm thick material with a strong sticker designed for the offroad use
- Silk-screen printing with resistant and shiny inks
- Kits include: radiator shrouds pair, front fender and rear fender

FITS MODEL	PART #	FITS MODEL	PART #	FITS MODEL	PART #
GRAPHIC KITS		GRAPHIC KITS (CONT)		GRAPHIC KITS (CONT)	
MC/EC 21-23	4302-7408	EC/FSR 07-11	4302-7403	EC 18-20	4302-7407
MC/EC 24-25	4302-7409	EC 10-11, EC-F 10-13	4302-7405	FORKGUARD STICKERS	
EC/FSE 02-06	4302-7404	EC 12-15, EC-F 15	4302-7406	MC/EC 21-23	4302-7410



REPLICA TEAM GRAPHIC KIT, AND SEAT COVER FOR GASGAS

- Graphic kit includes: radiator shrouds, front fender, rear fender, airbox, fork protectors and swingarm graphics (number plate backgrounds not included)

REPLICA SEAT COVER FOR GASGAS

- Contours perfectly to the shape of the OEM seat
- Non-slip material for extra control
- Water-resistant
- See page 468 of the 2024 Parts Europe Offroad catalog for the complete line of Blackbird Replica Team graphic kits for GasGas



FITS MODEL	GRAPHIC KIT PART #	SEAT COVER PART #
GASGAS FACTORY 2023		
MC/EC (all) 21-23	4302-7299	0821-3613
MC/EC (all) 24-25	4302-7300	-

EXHAUST

LUGGAGE

BIKE STANDS & ACCESSORIES

HANDLEBARS & HAND CONTROLS

FOOTPEGS & FOOT CONTROLS

BODY

GRAPHICS & SEATS

SPROCKETS

CHAINS

BRAKES

WHEELS & ACCESSORIES

SUSPENSION

ELECTRICAL & GAUGES

LIGHTING

ENGINE

FUEL/AIR SYSTEMS

HARDWARE & MERCHANDISING



4302-7411

DREAM 4 GRAPHIC KITS FOR FANTIC

- 0,5 mm thick material with a strong sticker designed for offroad use
- Silk-screen printing with resistant and shiny inks
- Kits include: radiator shrouds pair, front fender and rear fender

FITS MODEL	PART #	FITS MODEL	PART #	FITS MODEL	PART #
FANTIC		FANTIC (CONT)		FANTIC (CONT)	
XX/XE (all) 21-23	4302-7411	XXF/XEF 450 22-23	4302-7412	XXF/XEF 450 24-25	4302-7413



DREAM 4 GRAPHIC KIT FOR SHERCO

- 0,5 mm thick material with a strong sticker designed for offroad use
- Silk-screen printing with resistant and shiny inks
- Kit includes: radiator shrouds pair, front fender and rear fender

FITS MODEL	PART #
SE/SEF 17-23	4302-7414

FORK STICKERS

- Sold in pairs
- See page 469 of the 2024 Parts Europe Offroad catalog for the complete line of Blackbird fork stickers

DESCRIPTION	PART #
KYB, black	4320-2590

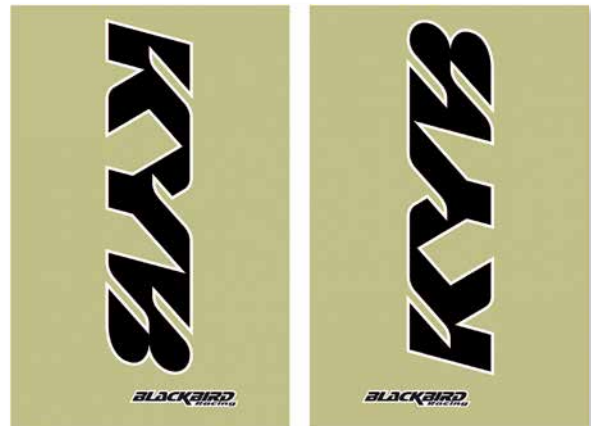



0821-3602



0821-3584



0821-3601



0821-3582

EXHAUST

LUGGAGE

BIKE STANDS & ACCESSORIES

HANDLEBARS & HAND CONTROLS

FOOTPEGS & FOOT CONTROLS

BODY

GRAPHICS & SEATS

SPROCKETS

CHAINS

BRAKES

WHEELS & ACCESSORIES

SUSPENSION

ELECTRICAL & GAUGES

LIGHTING

ENGINE

FUEL/AIR SYSTEMS

HARDWARE & MERCHANDISING

ZEBRA SEAT COVERS

- Excellent non-slip performance and durability
- Aggressive, up-to-date look
- Easy application and exceptional wear resistance
- See page 472 of the 2024 Parts Europe Offroad catalog for the complete line of Blackbird Zebra seat covers

FITS MODEL	COLOR	PART #
BETA		
RR 13-19	Black/red	0821-3602
HONDA		
CRF 250R 18-21, CRF 450R 17-20	Black/red	0821-3581
KTM		
SX/SX-F 19-22, EXC 20-23	Black/orange	0821-3584

FITS MODEL	COLOR	PART #
SUZUKI		
RM-Z 250 19-24, RM-Z 450 18-24	Black/yellow	0821-3601
YAMAHA		
YZ 250F-450F 06-09, WR 250F 07-14, WR 450F 07-11	Black/blue	0821-3582
YZ 250F 19-23, YZ 450F 18-22, WR 250F 20-23, WR 450F 19-23	Black/blue	0821-3583



0821-3618



0821-3605

PYRAMID SEAT COVERS

- New-generation anti-slip effect, made in material with excellent grip and a rubbery consistency that gives the rider perfect adherence to the seat in all conditions
- Excellent wear resistance
- Easy to apply, shaped parts specially studied to fit the shape of the seat
- See page 471 of the 2024 Parts Europe Offroad catalog for the complete line of Blackbird Pyramid seat covers

FITS MODEL	COLOR	PART #
KTM		
SX 50 24-25	Orange	0821-3604
SX 65 24-25	Orange	0821-3606
SX 85 24	Orange	0821-3618

BLUE MOON SEAT COVERS

- Distinctive fabric that's both long-lasting and superbly stylish
- Ability to withstand extreme stress and the most punishing race conditions
- Washable
- Available in blue
- See page 473 of the 2024 Parts Europe Offroad catalog for the complete line of Blackbird Blue Moon seat covers

FITS MODEL	PART #
KTM	
SX 50 24-25	0821-3605
SX 65 24-25	0821-3607



EXHAUST

LUGGAGE

BIKE STANDS & ACCESSORIES

HANDLEBARS & HAND CONTROLS

FOOTPEGS & FOOT CONTROLS

BODY



4302-7267



CANDY CHROME SERIES GRAPHICS

- Printed on silver chrome, ultra curve vinyl
- Moto-specific adhesives
- Trim kits include graphics for front fender, rear fender, upper fork, swingarm and logo stickers

FITS MODEL	AIRBOX/SHROUD KITS PART #	TRIM KITS PART #
GASGAS		
MC 125-450F, EX 300-450F 21-23	4302-7267	4302-7287
MC 125-450F, EX 300-450F 24-25	4302-7268	4302-7288

GRAPHICS & SEATS

SPROCKETS

CHAINS

BRAKES



4302-7269



CANDY CHROME SERIES GRAPHICS TRIM KITS

- Printed on silver chrome, ultra curve vinyl
- Moto-specific adhesives
- Trim kits include graphics for front fender, rear fender, upper fork, swingarm and logo stickers

FITS MODEL	PART #	FITS MODEL	PART #
HONDA		HONDA (CONT)	
CRF 250R 14-17	4302-7269	CRF 450R 13-16	4302-7269
CRF 250R 18-21	4302-7270	CRF 450R 17-20	4302-7270
CRF 250R 22-24	4302-7271	CRF 450R 21-24	4302-7271

SUSPENSION

ELECTRICAL & GAUGES

LIGHTING

ENGINE



4302-7265



CANDY CHROME SERIES GRAPHICS

- Printed on silver chrome, ultra curve vinyl
- Moto-specific adhesives
- Trim kits include graphics for front fender, rear fender, upper fork, swingarm and logo stickers

FITS MODEL	AIRBOX/SHROUD KITS PART #	TRIM KITS PART #
HUSQVARNA		
FC 250-450 18-21 FE., TC/FC/TX/FX 19-22, FE/TE 20-23	4302-7265	4302-7285
FC 250-450 22-23 Rockstar Edition, TC/FC/TX/FX 125-450 23-24, FE/TE 24-25	4302-7266	4302-7286



4302-7256



EXHAUST

LUGGAGE

BIKE STANDS & ACCESSORIES

HANDLEBARS & HAND CONTROLS

FOOTPEGS & FOOT CONTROLS

BODY

GRAPHICS & SEATS

SPROCKETS

CHAINS

BRAKES

WHEELS & ACCESSORIES

SUSPENSION

ELECTRICAL & GAUGES

LIGHTING

ENGINE

FUEL/AIR SYSTEMS

HARDWARE & MERCHANDISING

CANDY CHROME SERIES GRAPHICS

- Printed on silver chrome, ultra curve vinyl
- Moto-specific adhesives
- Trim kits include graphics for front fender, rear fender, upper fork, swingarm and logo stickers

FITS MODEL	AIRBOX/SHROUD KITS PART #	TRIM KITS PART #	FITS MODEL	AIRBOX/SHROUD KITS PART #	TRIM KITS PART #
KAWASAKI			KAWASAKI (CONT)		
KX 250 21-24	4302-7258	4302-7279	KX 450F 16-18	4302-7257	4302-7278
KX 250 25	4302-7259	4302-7280	KX 450 19-23	4302-7258	4302-7279
KX 250F 17-20	4302-7256	4302-7277	KX 450 24-25	4302-7259	4302-7280

4302-7137



EVO SERIES GRAPHIC KITS

- Pre-cut kits are printed on durable, scratch-resistant 16-mil Ultracurve® vinyl that is four times thicker than stock
- Special gas tank adhesive and anti-sag tabs
- Includes tank, front and side decals

FITS MODEL	EVO 20 PART #	FITS MODEL	EVO 20 PART #
KAWASAKI		KAWASAKI (CONT)	
KX 65 00-25	4302-7137	KLX 110 02-09	4302-7137



4302-7261



CANDY CHROME SERIES GRAPHICS

- Printed on silver chrome, ultra curve vinyl
- Moto-specific adhesives
- Trim kits include graphics for front fender, rear fender, upper fork, swingarm and logo stickers

FITS MODEL	AIRBOX/SHROUD KITS PART #	TRIM KITS PART #
KTM		
SX-F 250-450 15-17 FE., SX/SX-F 16-18, EXC 17-19	4302-7261	4302-7282
SX-F 250-450 18-21 FE., SX/SX-F 125-450 19-22, EXC 20-23	4302-7263	4302-7283
SX-F 250-450 22-23 FE., SX/SX-F 125-450 23-24, EXC 24-25	4302-7264	4302-7284



EXHAUST

LUGGAGE

BIKE STANDS & ACCESSORIES

HANDLEBARS & HAND CONTROLS

FOOTPEGS & FOOT CONTROLS

BODY

GRAPHICS & SEATS

SPROCKETS

CHAINS

BRAKES

WHEELS & ACCESSORIES

SUSPENSION

ELECTRICAL & GAUGES

LIGHTING

ENGINE

FUEL/AIR SYSTEMS

HARDWARE & MERCHANDISING



4302-7260



CANDY CHROME SERIES GRAPHICS FOR SUZUKI

- Printed on silver chrome, ultra curve vinyl
- Moto-specific adhesives
- Trim kits include graphics for front fender, rear fender, upper fork, swingarm and logo stickers

FITS MODEL	AIRBOX/SHROUD KIT PART #	TRIM KIT PART #	FITS MODEL	AIRBOX/SHROUD KIT PART #	TRIM KIT PART #
SUZUKI			SUZUKI (CONT)		
RM-Z 250 19-25	4302-7260	4302-7281	RM-Z 450 18-25	4302-7260	4302-7281



4302-7272



CANDY CHROME SERIES GRAPHICS TRIM KITS

- Printed on silver chrome, ultra curve vinyl
- Moto-specific adhesives
- Trim kits include graphics for front fender, rear fender, upper fork, swingarm and logo stickers

FITS MODEL	PART #	FITS MODEL	PART #
YAMAHA		YAMAHA (CONT)	
YZ 125/250 15-21	4302-7272	YZ 250F 24-25	4302-7276
YZ 125/250 22-25	4302-7273	YZ 450F 14-17	4302-7274
YZ 250F 14-18	4302-7274	YZ 450F 18-22	4302-7275
YZ 250F 19-23	4302-7275	YZ 450F 23-25	4302-7276

- EXHAUST
- LUGGAGE
- BIKE STANDS & ACCESSORIES
- HANDLEBARS & HAND CONTROLS
- FOOTPEGS & FOOT CONTROLS
- BODY
- GRAPHICS & SEATS
- SPROCKETS
- CHAINS
- BRAKES
- WHEELS & ACCESSORIES
- SUSPENSION
- ELECTRICAL & GAUGES
- LIGHTING
- ENGINE
- FUEL/AIR SYSTEMS
- HARDWARE & MERCHANDISING



COMPLETE GRAPHICS KITS

- Includes decals for radiator shrouds, tank, number plate, airbox, lower fork guards, front fender, rear fender and swingarm
- See page 493 of the 2024 Parts Europe Offroad catalog for the complete line of D'Cor Visuals Kawasaki complete graphics kits

FITS MODEL	DESCRIPTION	PART #	FITS MODEL	DESCRIPTION	PART #
KAWASAKI			KAWASAKI (CONT)		
KX 85/112 22-25	2024 Monster Energy, black background	4302-7205	KX 450 19-23	1993 KX Retro, white background	4302-7210
KX 250 21-24	2024 Monster Energy, black background	4302-7213		2024 Monster Energy, white background	4302-7214
KX 250 25	1993 KX Retro, white background	4302-7211	KX 450 24-25	1993 KX Retro, white background	4302-7211
	2024 Monster Energy, white background	4302-7215		2024 Monster Energy, white background	4302-7215



PRE-CUT FRAME GRIP TAPE

- Pre-cut to fit model specific applications
- High-strength adhesive
- Aggressive rubberized grip texture
- See page 493 of the 2024 Parts Europe Offroad catalog for the complete line of D'Cor Visuals Kawasaki pre-cut frame grip tape

FITS MODEL	COLOR	PART #
KAWASAKI		
KX 250/KX 450 24-25	Gray	4320-2575
	Green/black	4320-2576

EXHAUST

LUGGAGE

BIKE STANDS & ACCESSORIES

HANDLEBARS & HAND CONTROLS

FOOTPEGS & FOOT CONTROLS

BODY

GRAPHICS & SEATS

SPROCKETS

CHAINS

BRAKES

WHEELS & ACCESSORIES

SUSPENSION

ELECTRICAL & GAUGES

LIGHTING

ENGINE

FUEL/AIR SYSTEMS

HARDWARE & MERCHANDISING



COMPLETE GRAPHICS KITS

- Includes decals for radiator shrouds, tank, number plate, airbox, lower fork guards, front fender, rear fender and swingarm
- See page 495 of the 2024 Parts Europe Offroad catalog for the complete line of D'Cor Visuals Yamaha complete graphics kits

FITS MODEL	DESCRIPTION	PART #
YAMAHA		
YZ 65 18-25	2024 Star Racing Monster Energy Yamaha, black background	4302-7216
YZ 85 22-25	1993 YZ Retro, black background	4302-7223
YZ 125/250 15-21	1993 YZ Retro, white background	4302-7224
	1993 YZ Retro Star Racing Monster Energy Yamaha, white background	4302-7220
	2024 Star Racing Monster Energy Yamaha, white background	4302-7219
YZ 125/250 22-25	1993 YZ Retro, white background	4302-7225
	1993 YZ Retro Star Racing Monster Energy Yamaha, white background	4302-7221
YZ 250F 19-23	1993 YZ Retro, black background	4302-7226
	1993 YZ Retro Star Racing Monster Energy Yamaha, black background	4302-7230
YZ 250F 24-25	Monster Energy Slash, white background	4302-7218
	1993 YZ Retro, black background	4302-7227
	1993 YZ Retro Star Racing Monster Energy Yamaha, black background	4302-7232
	2024 Star Racing Monster Energy Yamaha, black background	4302-7231
YZ 450F 18-22	1993 YZ Retro, white background	4302-7228
	1993 YZ Retro Star Racing Monster Energy Yamaha, white background	4302-7235
	2024 Star Racing Monster Energy Yamaha, white background	4302-7234
YZ 450F 23-25	Monster Energy Slash, white background	4302-7218
	1993 YZ Retro, white background	4302-7229
	1993 YZ Retro Star Racing Monster Energy Yamaha, white background	4302-7236



DECAL LOGO KITS

- Great for bikes, cars, trucks, toolboxes and more
- Pre-cut stickers made from PVC (0,1 mm thick)
- Sheet measures 50 cm x 35 cm
- UV protection ink
- For the full line of Decal Logo kits see page 502 of the 2024 Parts Europe Offroad catalog

DESCRIPTION	PART #
Bomb	4320-2588
Whipriders	4320-2589



4320-2588



4320-2589



4320-2595



4320-2596



4320-2597



4320-2600



UNIVERSAL DECAL SHEETS

- High-quality stickers
- Hi-Tack adhesive
- UV coating
- Available in 12-mil thickness
- See page 505 of the 2024 Parts Europe Offroad catalog for the complete line of D'Cor Visuals universal decal sheets

DESCRIPTION	PART #
Honda Retro	4320-2595
Kawasaki Monster Energy Bee G	4320-2596
KTM Retro	4320-2597



4320-2599



4320-2598

DESCRIPTION	PART #
Star Yamaha Monster Bee G	4320-2600
Star Yamaha Team	4320-2599
Yamaha Retro	4320-2598



4320-2579



4320-2580



4320-2581



FENDER/TRAILER STICKERS

- Made from the best graphics material on the market
- Classic FMF available in three sizes

DESCRIPTION	PART #	DESCRIPTION	PART #	DESCRIPTION	PART #
Go Fast, Have Fun	4320-2579	FMF logo, red, white, and blue	4320-2580	FMF logo, red	4320-2581



FRONT FORK STICKER SET

- Red KYB Factory team replica sticker

DESCRIPTION	PART #
Front fork sticker set	4320-2577



DECALS

- See page 507 of the 2024 Parts Europe Offroad catalog for the full line of Moose Racing decals

DESCRIPTION	PART #
Moose Stacked (100 pk.)	9904-0334

EXHAUST

LUGGAGE

BIKE STANDS & ACCESSORIES

HANDLEBARS & HAND CONTROLS

FOOTPEGS & FOOT CONTROLS

BODY

GRAPHICS & SEATS

SPROCKETS

CHAINS

BRAKES

WHEELS & ACCESSORIES

SUSPENSION

ELECTRICAL & GAUGES

LIGHTING

ENGINE

FUEL/AIR SYSTEMS

HARDWARE & MERCHANDISING

EXHAUST

LUGGAGE

BIKE STANDS & ACCESSORIES

HANDLEBARS & HAND CONTROLS

FOOTPEGS & FOOT CONTROLS

BODY

GRAPHICS & SEATS

SPROCKETS

CHAINS

BRAKES

WHEELS & ACCESSORIES

SUSPENSION

ELECTRICAL & GAUGES

LIGHTING

ENGINE

FUEL/AIR SYSTEMS

HARDWARE & MERCHANDISING



0811-0279



0811-0278



COMPLETE SEATS

- Identical dimensions and superior quality compared to OEM seats
- Closed-cell polyurethane foam derived from aerospace applications reduces weight and offers more weather protection
- Polypropylene plastic bottom

- Durable water-resistant cover
- Non-slip material gives the rider excellent control
- Seat foam available in standard height or high (+15 mm)

FITS MODEL	PART #
GASGAS	
MC 125 21-23, MC 250 22-23, MC 250F-450F 21-23	0811-0279
EC 250-350 21-23, EC 350F 21-23	0811-0279
KAWASAKI	
KX 250F 13-16	0811-0280

FITS MODEL	PART #
KAWASAKI (CONT)	
KX 450F 12-15	0811-0280
YAMAHA	
YZ 125/250 02-21	0811-0278



GRIPPER SEAT COVER

- Rubberized "Diamond" gripper material
- Doubled-stitched for durability
- Superior traction in all riding conditions
- See page 518 of the 2024 Parts Europe Offroad catalog for Moose Racing's complete line of gripper seat covers



FITS MODEL	PART #
YAMAHA	
YZ 125/250 02-21	0821-1062



RIBBED SEAT COVERS

- Ribbed traction seat cover
- Rubberized material
- Superior traction wet or dry
- UV-protected for long life
- Double-stitched for durability
- See pages 519-520 of the 2024 Parts Europe Offroad catalog for Moose Racing's full line of ribbed seat covers



0821-1793

FITS MODEL	COLOR	PART #
KTM		
200/250/450 03 (all), SX 125-525 04-06, EXC/MXC 125-530 04-07	Black/orange ribbed	0821-1793

FITS MODEL	COLOR	PART #
YAMAHA		
YZ 250F 14-18	Black/blue ribbed	0821-1814
YZ 450F 14-17	Black/blue ribbed	0821-1814



SEAT COVERS

- Provides exceptional grip, wet or dry
- Watertight construction
- Perfect replacement for OEM motorcycle seat covers
- For the full line of seat covers see page 521 of the 2024 Parts Europe Offroad catalog



0821-3616



FITS MODEL	PART #
TRIUMPH	
TF 250-X 24-25	0821-3616

FITS MODEL	PART #
STARK	
Varg 24-25	0821-3617



1212-2217

EXHAUST

LUGGAGE

BIKE STANDS & ACCESSORIES

HANDLEBARS & HAND CONTROLS

FOOTPEGS & FOOT CONTROLS

BODY

GRAPHICS & SEATS

SPROCKETS

CHAINS

BRAKES

WHEELS & ACCESSORIES

SUSPENSION

ELECTRICAL & GAUGES

LIGHTING

ENGINE

FUEL/AIR SYSTEMS

HARDWARE & MERCHANDISING

CHROMOLY STEEL FRONT SPROCKETS

- Machined from impact and wear resistant chromoly steel
- Inner splines are broached to provide maximum spline-to-countershaft contact - this helps distribute driveline forces over the largest possible area
- Heat-treated, then finished with a nickel coating for corrosion resistance and lubricity
- BE SURE TO CHECK FOR CLEARANCE WHEN ORDERING SIZES LARGER THAN STOCK
- See pages 530-540 of the 2024 Parts Europe Offroad catalog for the complete line of Moose Racing Sprockets

FITS MODEL	CHAIN	STANDARD GEARING	FRONT SIZE	PART #
BETA				
RR 2T 250 05-12	520-120	14/52	13	1212-2217
RR 4T 350 11-12	520-120	13/50	14	1212-2218
RR 4T 400/450 05-12	520-120	13/50	15	1212-2219
RR 4T 498 12-13	520-120	13/48	16	1212-2220
RR 4T 520 10-14	520-120	13/48		
RR 4T 500/525 05-11	520-120	14/50		
GASGAS				
MC 85 (17/14) 21-25	428-124	13/46	13	1212-2280
MC 85 (19/16) 21-25	428-124	13/49	14	1212-2281
EC/ECR 125 99-15	520-120	13/48	12	1212-2193
			13	1212-2194
			14	1212-2195
			15	1212-2196
EC/ECR 200 99-15,	520-120	13/48	12	1212-2276
MC/EC/ECR 250 97-15,			13	1212-2277
MC/EC/ECR/ECF 300 00-15,				
EC/SM 400-515 00-15				
HONDA				
CR 60R 83-84	420-104	14/45	12	1212-2057
			13	1212-2058
			14	1212-2059
			15	1212-2060
CR 80R 85	420-114	14/49	12	1212-2057
			13	1212-2058
			14	1212-2059
			15	1212-2060
CR 80R 86-02, CR 85R 03-07	420-116	15/49	14	1212-2080
			15	1212-2081
CR 125R 87-96	520-114	13/51	12	1212-2083
CR 125R 97	520-114	12/49	13	1212-2084
CR 125R 98-99	520-114	13/51		
CR 125R 00-01	520-114	13/52		
CR 125R 02	520-114	13/51		
CR 125R 03	520-116	13/52		
CR 125R 04	520-116	13/53	13	1212-2120
CR 125R 05-07	520-116	13/52	14	1212-2121
CR 250R 84-87	520-114	14/53	14	1212-2076

FITS MODEL	CHAIN	STANDARD GEARING	FRONT SIZE	PART #
HONDA (CONT)				
CR 250R 88-91	520-116	14/51	12	1212-2085
CR 250R 92-95	520-114	13/49	13	1212-2086
CR 250R 96-01	520-114	13/50	14	1212-2087
CR 250R 02-03	520-114	13/48	15	1212-2088
CR 250R 04	520-114	13/50		
CR 250R 05-08	520-114	13/49		
CR 500R 86-87	520-116	14/51	14	1212-2095
			15	1212-2096
CR 500R 88-91	520-116	14/51	12	1212-2085
CR 500R 92-01	520-114	14/49	13	1212-2086
			14	1212-2087
			15	1212-2088
CRF 50/XR 50R 00-25	420/78	14/37	14	1212-2080
			15	1212-2081
CRF/XR 70R 00-12	420-86	15/36	14	1212-2080
			15	1212-2081
CRF/XR 80R 85-13,	420-110	14/46	12	1212-2061
XR 70R 97-99			13	1212-2062
			14	1212-2063
			15	1212-2064
CRF/XR 100 85-13	428-118	14/50	13	1212-2065
			14	1212-2066
			15	1212-2067
CRF 110F 13-25	420-86	14/38	12	1212-2057
			13	1212-2058
			14	1212-2059
			15	1212-2060
CRF 125F/FB 07-25	428-112	13/46	13	1212-2278
			14	1212-2279
CRF 150R/RB EXP 07-25	420-120	15/50	14	1212-2240
			15	1212-2241
CRF 150F 03-05	520-104	13/48	13	1212-2100
CRF 150F 06-17	520-104	13/47	14	1212-2101
CRF 230F 03-25	520-112	13/50	-	
CRF 230L 08-09	520-100	13/39	13	1212-2078
			14	1212-2079
CRF 250F 19-25	520-120	13/50	12	1212-2112
			13	1212-2113
			14	1212-2114

CHROMOLY STEEL FRONT SPROCKETS continued on next page.



CHROMOLY STEEL FRONT SPROCKETS (CONT)

	FITS MODEL	CHAIN	STANDARD GEARING	FRONT SIZE	PART #	FITS MODEL	CHAIN	STANDARD GEARING	FRONT SIZE	PART #
EXHAUST	HONDA (CONT)					HUSQVARNA (CONT)				
	CRF 250L 13-25	520-120	14/40	12	1212-2112	TC 125 14-25	520-120	13/50	12	1212-2217
LUGGAGE				13	1212-2113	TC 250 14-25	520-120	13/48	13	1212-2218
				14	1212-2114	FC 250 14-25	520-120	13/50	14	1212-2219
BIKE STANDS & ACCESSORIES	CRF 250R 04-10	520-114	13/51	13	1212-2120	FC 450 14-25	520-120	13/48	15	1212-2220
	CRF 250R 11-17	520-116	13/48	14	1212-2121	TE 150 17-25	520-120	13/50		
HANDLEBARS & HAND CONTROLS	CRF 250X 04-17	520-116	14/53			TE 125 16-19	520-120	13/50		
	CRF 250R/RX 18-25	520-120	13/48	13	1212-2246	TE 250 14-25	520-120	13/50		
FOOTPEGS & FOOT CONTROLS				14	1212-2247	TE 300 14-25	520-120	13/50		
	CRF 450R 02-03	520-114	13/50	12	1212-2085	FE 250 14-25	520-120	13/52		
BODY	CRF 450R 04-19	520-114	13/48	13	1212-2086	FE 350 14-25	520-120	14/52		
	CRF 450R 09-25	520-116	13/49	14	1212-2087	FE 450 14-25	520-120	13/50		
GRAPHICS & SEATS	CRF 450RX 17-25	520-114	13/50	15	1212-2088	FE 501 14-15	520-120	14/52		
	CRF 450RWE 17-25	520/120	13/51			FE 501 16-25	520-120	13/50		
SPROCKETS	CRF 450X 05-25	520/114	13/51			FE 501 18-25	520-120	12/45		
	XR 70R 97-99	420-86	15/36	12	1212-2057	KAWASAKI				
CHAINS				13	1212-2058	KX 60 83-03	420-104	13/44	12	1212-2193
	XR 200R 84	520-102	13/45	12	1212-2089	KX 65 00-01	420-108	13/46	13	1212-2194
BRAKES	XR 200R 86-02	520-108	13/47	13	1212-2090	KX 80 86-00	420-124	13/51	14	1212-2195
				14	1212-2091				15	1212-2196
WHEELS & ACCESSORIES				15	1212-2092	KX 125 94-95	520-110	12/49	12	1212-2130
	XR 250R 84-87	520-108	13/50	13	1212-2090	KX 125 96-97	520-112	13/50	13	1212-2131
SUSPENSION	XR 250R 88-89	520-108	13/48	13	1212-2100	KX 125 98-99	520-110	12/48	14	1212-2132
				14	1212-2101	KX 125 00-02	520-110	12/49	15	1212-2133
ELECTRICAL & GAUGES	XR 250R 96-05	520-106	13/48	12	1212-2112	KX 125 03-08	520-110	13/51		
				13	1212-2113	KX 250 85-86	520-112	14/50	13	1212-2134
LIGHTING				14	1212-2114				14	1212-2135
	XR/XL 350R 83-85	520-106	14/40-42	14	1212-2079	KX 250 87-89, 00	520-114	14/47	12	1212-2122
ENGINE				13	1212-2116	KX 250 90-91, 01	520-114	14/48	13	1212-2123
				14	1212-2117	KX 250 92-97	520-114	14/49	14	1212-2124
FUEL/AIR SYSTEMS				15	1212-2118	KX 250 98-99	520-112	13/48		
				16	1212-2119	KX 250 02-04	520-114	13/49		
HARDWARE & MERCHANDISING	XR 400R 96-04	520-108	15/45	13	1212-2116	KX 250 05-07	520-116	13/51		
				14	1212-2117	KDX 250 91-94	520-114	13/47		
	XR 500R 83-85	520-108	14/48	14	1212-2069	KX 500 83-84	520-112	14/43	13	1212-2134
				15	1212-2070	KX 500 85	520-112	14/46	14	1212-2135
	XL 600 V Transalp 87-00 (87-99 US)	520/120	15/47	15	1212-2093	KX 500 86	520-114	14/48		
	XL 650 V Transalp 01-07	520/120	15/48	16	1212-2094	KX 250F 04-05	520-114	13/48	12	1212-2156
	XR 600R 85-87	520-110		13	1212-2068				13	1212-2157
				14	1212-2069				14	1212-2158
				15	1212-2070	KX 250F 06-10	520-112	13/48	12	1212-2250
	XR 600R 91-00	520-110	14/48	14	1212-2107	KX 250F 11-25/KX 250X 21-25	520-114	13/50	13	1212-2251
	XR 650L 93-24	520-112	15/45	15	1212-2108	KX 450F 06-25/KX 450X 21-25	520-114	13/50	12	1212-2253
				16	1212-2105				13	1212-2254
	XR 650R 00-07	520-110	14/48	14	1212-2248				14	1212-2255
				15	1212-2249				15	1212-2256
	NC 700X 12-15	520/130	16/43	15	1212-2242	KDX 200/220 89-06	520-108	13/47	12	1212-2122
	NC 750X/XA 14-18	520/130	17/43	16	1212-2243				13	1212-2123
	NC 750XD DCT 14-18	520/130	17/39	17	1212-2245	KLX 110/L/R 02-25	420-106	14/42	13	1212-2126
	XRV 750 Africa Twin 90-03	520/130	16/46	15	1212-2097				14	1212-2127
				16	1212-2098				15	1212-2128
				17	1212-2099	KLX 125/L 03-06	428-122	14/51	14	1212-2167
	XL 1000 V Varadero 99-13	520/130	16/47	14	1212-2109				15	1212-2168
				15	1212-2110	KLX 140 08-24	428-122	14/50	12	1212-2136
				16	1212-2111	KLX 140G 19-24	428-126	13/57	13	1212-2137
	HUSABERG					KLX 250/300 90-06	520-110	14/50	12	1212-2122
	TE 350 92-00			12	1212-2227				13	1212-2123
	FC/FE/FS/FX 350-600 92-00			13	1212-2228	KLX 250S 06-07	520-106	14/42	12	1212-2139
	MX 499/600 91-93			14	1212-2229				13	1212-2140
				15	1212-2230				14	1212-2141
				16	1212-2231				15	1212-2142
	TE 125/250/300 11-14	520-120	13/50	12	1212-2217	KLX300R 03-07	520-110	14/50	15	1212-2181
	FE 250 13-14	520-120	14/50	13	1212-2218				16	1212-2182
	FE 350/390/450 09-13	520-120	13/52	14	1212-2219	KLX 300R 20-24	520-110	14/50	12	1212-2139
	FE 501 13-14	520-120	14/52	15	1212-2220				13	1212-2140
	FE 570 09-12	520-120	13/52						14	1212-2141
	HUSQVARNA								15	1212-2142
	TC 65 17-23	428-116	14/48	13	1212-2272					
				14	1212-2273					
	TC 85 14-25 (all)	428-124	14/47	13	1212-2274					
				14	1212-2275					
	TC 85 (17/14) 18-25	428-124	13/46	13	1212-2280					
	TC 85 (19/16) 18-25	428-124	13/49	14	1212-2281					



CHROMOLY STEEL FRONT SPROCKETS (CONT)

FITS MODEL	CHAIN	STANDARD GEARING	FRONT SIZE	PART #
KAWASAKI (CONT)				
KLX 400R/SR 03	520-112	14/47	12	1212-2162
			13	1212-2163
			14	1212-2164
			15	1212-2165
KLX 450R 08-09/18-19	520-114	13/50	15	1212-2181
			16	1212-2182
KLR 650 87-95	520-106	15/43	14	1212-2138
			16	1212-2143
KLR 650 98-17	520-106	15/43	14	1212-2144
			15	1212-2145
KLX 650 93-96	520-112	15/43	15	1212-2145
KLX 650 R 99-01	520-112	-	16	1212-2146
KLE 650 Versys 07-17	520-112	15/46	15	1212-2181
			16	1212-2182
KTM				
SX 60/65 98-02	420-112	13/46	13	1212-2272
SX 65 03-23	420-112	14/50	14	1212-2273
SX 85 03-17	428-124	14/46	13	1212-2274
SX 105 04-13	428-124	14/49	14	1212-2275
SX 85 (17/14) 18-25	428-124	13/46	13	1212-2280
SX 85 (19/16) 18-25	428-124	13/49	14	1212-2281
SX/EXC 125/144/150/200/250/ 300/350/360/380/400/450/525/ 530 90-25	520-120	-	11	1212-2215
			12	1212-2216
			13	1212-2217
			14	1212-2218
			15	1212-2219
SX-F 250 05-22	520-120	14/50	11	1212-2215
			12	1212-2216
EXC 4-Stroke 250 03-06	520-120	14/52	12	1212-2216
SX 500 92	520-120	-	12	1212-2216
SX-F 505 07-09	520-120	14/52	13	1212-2217
SX/EXC 520 99-02	520-120	14/50	14	1212-2218
SX/EXC/MXC/SMC 525 03-07	520-120	14/48	15	1212-2219
EXC-R 530 08-11	520-120	15/45		
XCR-W 530 08-11	520-120	14/50		
DXC/MXC 550 92-97	520-120			
RXC LC4 400 93-02	520-120	14/50	12	1212-2221
LC4 600 90-93	520-120		13	1212-2222
LC4/Duke/MX 620 94-99	520-120		14	1212-2223
			15	1212-2224
			16	1212-2225
			17	1212-2226
SUZUKI				
TS 50 Gaucho 71-74	420-112	11/33	11	1212-2149
			12	1212-2150
			13	1212-2151
			14	1212-2152
			15	1212-2153
			16	1212-2154
			17	1212-2155
RM 60 03	420-104	13/44	12	1212-2190
RM 65 03-06	420-110	13/47	13	1212-2191
RM 100 03	420-124	13/51	14	1212-2192
RM 80 83	428-118	13/50	12	1212-2197
RM 80 84-85	428-114	13/44	13	1212-2198
RM 80 89-01	428-118	14/48	14	1212-2199
RM 85/L 02-25	428-122	14/47	15	1212-2200
RM 125 80-84	520-114	12/51	12	1212-2160
RM 125 85	520-114	12/49	13	1212-2161
RM 125 86-87	520-114	12/51		
RM 125 88-91	520-114	13/51		
RM 125 92-05	520-114	12/49		
RM 125 97-99	520-114	12/50		
RM 125 06-12	520-114	12/51		
RM 250 82	520-114	14/49	12	1212-2162
RM 250 83	520-116	14/50	13	1212-2163
			14	1212-2164
			15	1212-2165

FITS MODEL	CHAIN	STANDARD GEARING	FRONT SIZE	PART #
SUZUKI (CONT)				
RM-Z 250 04-06	520-114	13/48	12	1212-2156
			13	1212-2157
			14	1212-2158
			15	1212-2159
RM-Z 250 07-09	520-112	12/48	12	1212-2160
RM-Z 250 10-12	520-114	13/49	13	1212-2161
RM-Z 250 13-25	520-114	13/49	13	1212-2259
			14	1212-2260
RM-Z 450 05-07	520-114	14/49	13	1212-2257
RM-Z 450 15-25	520-114	13/50	14	1212-2258
RMX 450Z 10-25	520-114	13/50		
RMX 250 89-01	520-114	13/50	12	1212-2162
			13	1212-2163
			14	1212-2164
			15	1212-2165
DR-Z 250 01-07	520-112	13/49	12	1212-2162
			13	1212-2163
			14	1212-2164
			15	1212-2165
DR-Z 400/E 00-09, 11-24	520-112	14/47	12	1212-2162
DR-Z 400SM 06-09, 11-24	520-110/ 112	15/41	13	1212-2163
DR-Z 400S 00-09, 13-24	520-112	15/44	14	1212-2164
			15	1212-2165
DR 250 90-93	520-110	13/49	12	1212-2162
			13	1212-2163
			14	1212-2164
			15	1212-2165
DR 650 SE 96-18	520-112	15/41	13	1212-2169
			14	1212-2170
			15	1212-2171
YAMAHA				
YZ 65 18-25	420-114	14/47	14	1212-2271
YZ 80 93-01	428-114	14/47	12	1212-2197
			13	1212-2198
			14	1212-2199
			15	1212-2200
YZ 85 02-25	428-118	14/47	14	1212-2203
YZ 100 82-83	520-106	-	12	1212-2130
			13	1212-2131
			14	1212-2132
			15	1212-2133
YZ 125 80-82	520-102	12/46-48	12	1212-2130
YZ 125 83-84	520-104	12/48	13	1212-2131
YZ 125 85	520-106	12/52	14	1212-2132
YZ 125 86	520-110	13/50	15	1212-2133
YZ 125 87-88	520-114	13/49		
YZ 125 05-25	520-112	13/48	12	1212-2266
YZ 125X 20-25	520-112	13/48	13	1212-2267
			14	1212-2268
XT 125 R 05-11	428-116	14/50	14	1212-2199
			15	1212-2200
YZ 250 74-76	520-106	13/50-52	12	1212-2122
			13	1212-2123
			14	1212-2124
			15	1212-2125
YZ 250 99-19	520-114	13/50	13	1212-2267
YZ 250 20-25	520-114	14/50	14	1212-2268
YZ 250X 16-25	520-114	13/50		
YZ 250F 01-06	520-112	13/48	13	1212-2267
YZ 250F 07-11	520-112	13/49	14	1212-2268
YZ 250F 12-25	520-114	13/50		
YZ 250FX 16-25	520-112	14/50		
WR 250F 01-06	520-112	13/52		
WR 250F 07-25	520-114	13/50		

CHROMOLY STEEL FRONT SPROCKETS continued on next page.

EXHAUST

LUGGAGE

BIKE STANDS & ACCESSORIES

HANDLEBARS & HAND CONTROLS

FOOTPEGS & FOOT CONTROLS

BODY

GRAPHICS & SEATS

SPROCKETS

CHAINS

BRAKES

WHEELS & ACCESSORIES

SUSPENSION

ELECTRICAL & GAUGES

LIGHTING

ENGINE

FUEL/AIR SYSTEMS

HARDWARE & MERCHANDISING



CHROMOLY STEEL FRONT SPROCKETS (CONT)

EXHAUST

LUGGAGE

BIKE STANDS & ACCESSORIES

HANDLEBARS & HAND CONTROLS

FOOTPEGS & FOOT CONTROLS

BODY

GRAPHICS & SEATS

SPROCKETS

CHAINS

BRAKES

WHEELS & ACCESSORIES

SUSPENSION

ELECTRICAL & GAUGES

LIGHTING

ENGINE

FUEL/AIR SYSTEMS

HARDWARE & MERCHANDISING

FITS MODEL	CHAIN	STANDARD GEARING	FRONT SIZE	PART #
YAMAHA (CONT)				
YZ/WR 400/426F 98-02	520-114	14/49	12	1212-2178
			13	1212-2179
			14	1212-2180
			15	1212-2181
WR 250R 08-20	520-116	13/43	13	1212-2267
			14	1212-2268
			13	1212-2264
			14	1212-2265
WR 250X 08-15	520-116	13/42	13	1212-2267
			14	1212-2268
			13	1212-2264
			14	1212-2265
TT-R 125 02-10	428-124	13/49	13	1212-2264
			14	1212-2265
			12	1212-2234
			13	1212-2235
TT-R 230 05-25	520-106	13/49	12	1212-2234
			13	1212-2235
			14	1212-2236
			13	1212-2212
TT-R 250 99-06	520-116	13/52	13	1212-2212
			14	1212-2213
			15	1212-2214

FITS MODEL	CHAIN	STANDARD GEARING	FRONT SIZE	PART #
YAMAHA (CONT)				
TT 600 RE 04-	520-108	15/47	14	1212-2204
			15	1212-2205
			16	1212-2206
XT 600 E 89-03	520-108	15/45	15	1212-2270
XT 660 R 04-15	520-108	15/45	13	1212-2102
XT 660 X (Super-Motard) 04-15	520-108		14	1212-2103
XTZ 660 Z Tenere 08-15	520-108		15	1212-2104
XTZ 750 Tenere 90-98	520-108	16/46	14	1212-2207
			15	1212-2208
			16	1212-2209
			17	1212-2210
			18	1212-2211



SPROCKETS FRONT SPROCKETS

- CNC machined from case-hardened and core-refined 655M13 nickel chromium steel
- Machined self-cleaning mud grooves at each tooth to help prevent mud buildup and increase wear resistance
- Certain models available in ultralight design for a 10 to 15% weight savings
- See pages 546 to 574 of the 2024 Parts Europe Offroad catalog for the full line of Renthal® sprockets

FITS MODEL	STOCK GEAR	FRONT SIZE	PART #
GASGAS			
MC 65 24-25	420-112	13	1212-2326
		14	1212-2327
HUSQVARNA			
TC 65 24-25	420-112	13	1212-2326
		14	1212-2327

1212-2295



FITS MODEL	STOCK GEAR	FRONT SIZE	PART #
KTM			
SX 65 24-25	420-112	13	1212-2326
		14	1212-2327
TRIUMPH			
TF 250-X 24-25	520-114	13	1212-2295
		14	1212-2296

1212-2282



STEEL FRONT SPROCKETS

- Constructed from top-grade hardened steel; will last up to three times longer than aluminium sprockets
- Drilled holes for lower weight
- Special coating for extra durability
- Race-proven design offers optimal strength-to-weight ratio
- CAD-designed and laser cut
- See pages 588-619 of the 2024 Parts Europe Offroad catalog for the complete line of Moto-Master sprockets

FITS MODEL	SIZE	PART #
HONDA		
CR 125 87-07	12	1212-2282
	13	1212-2283

FITS MODEL	SIZE	PART #
SHERCO		
SE/SEF/SE-R 250/300 21-25	12	1212-2341
	13	1212-2284
	14	1212-2285



1212-2323



1211-2825



EXHAUST

LUGGAGE

BIKE STANDS & ACCESSORIES

HANDLEBARS & HAND CONTROLS

FOOTPEGS & FOOT CONTROLS

BODY

GRAPHICS & SEATS

SPROCKETS

CHAINS

BRAKES

WHEELS & ACCESSORIES

SUSPENSION

ELECTRICAL & GAUGES

LIGHTING

ENGINE

FUEL/AIR SYSTEMS

HARDWARE & MERCHANDISING

SPROCKETS

FRONT SPROCKETS

- Durable hardened steel
- CNC-machined
- Ultralight with drilled weight reduction holes
- Coated for extra endurance

ALUMINUM REAR SPROCKETS

- CAD-designed and CNC-machined using state-of-the-art technology
- Optimized for maximum strength and lowest weight
- Aviation-grade 7075-T6 aluminium alloy construction
- Self-cleaning grooves between each tooth to prevent mud build-up
- Anodized coated surface for extra durability and sleek black finish

SPROCKET BOLTS AND NUTS

- Aerospace-grade titanium construction
- CNC-machined
- Ultra lightweight
- Sold in 6 pk.

SPROCKET BOLTS

DESCRIPTION	PART #	DESCRIPTION	PART #
European style	2401-1695	Japanese style	2401-1696

FRONT SPROCKETS

FITS MODEL	SIZE	PART #
BETA		
RR 125-480 05-25	12	1212-2345
	13	1212-2317
	14	1212-2318
FANTIC		
XX 125 21-25	13	1212-2323
XXF/XEF 250 22-25	14	1212-2324
XE 125 22-25	-	-
XX 250 22-25	13	1212-2312
XXF/XEF 450 22-25	14	1212-2313
GASGAS		
MC 65 21-23	14	1212-2314
MC 65 24-25	14	1212-2344
MC 85 21-25	13	1212-2315
	14	1212-2316
MC/EC 125-450	12	1212-2345
MC/EC 125F-450F 21-25	13	1212-2317
	14	1212-2318
HONDA		
CR/CRF 250R 88-07, 22-25	13	1212-2307
CRF 450F 02-25	14	1212-2308
CRF 250R 18-21	13	1212-2309

FITS MODEL	SIZE	PART #
HUSABERG		
TE 250/300 11-14	12	1212-2345
FE 250/350/501 11-14	13	1212-2317
	14	1212-2318
HUSQVARNA		
TC 65 18-23	14	1212-2314
TC 65 24-25	14	1212-2344
TC 85 14-25	13	1212-2315
	14	1212-2316
TC/FC/TE/FE 125-501 14-25	12	1212-2345
	13	1212-2317
	14	1212-2318
KAWASAKI		
KX 250 99-08	13	1212-2312
KX 450F 06-18	14	1212-2313
KX 450 19-25	-	-
KX 250F 06-18	13	1212-2310
KX 250 19-25	14	1212-2311
KTM		
SX 65 00-23	14	1212-2314
SX 65 24-25	14	1212-2344

FITS MODEL	SIZE	PART #
KTM (CONT)		
SX 85 04-25	13	1212-2315
	14	1212-2316
SX/SX-F/EXC/EXC-F 125-530 87-25	12	1212-2345
	13	1212-2317
	14	1212-2318
SUZUKI		
RM-Z 250 13-25	13	1212-2319
	14	1212-2320
RM-Z 450 08-25	13	1212-2321
	14	1212-2322
STARK		
Varg 23-25	12	1212-2345
	13	1212-2317
	14	1212-2318
TRIUMPH		
TF 250-X 24-25	13	1212-2346
YAMAHA		
YZ 125 05-25	13	1212-2323
YZ 250F/WR 250F 01-25	14	1212-2324
YZ 250 99-25	13	1212-2312
YZ 450F/WRF 450 98-25	14	1212-2313

REAR SPROCKETS

FITS MODEL	CHAIN TYPE	SIZE	PART #
GASGAS			
MC 125/250/250F/350F/450F 21-25	520	48	1211-2827
EC 250/300/250F/350F/450F/500F 21-25		49	1211-2828
		50	1211-2829
		51	1211-2830
		52	1211-2831
HONDA			
CR 125R 87-07	520	48	1211-2816
CR 250R 88-07		49	1211-2817
CR 500 88-01		50	1211-2818
CRF 250R 04-25		-	-
CRF 450R 02-25		-	-
CRF 150F 03-19		-	-
CRF 230F 03-19		-	-
CRF 250F 19-25		-	-
CRF 450L/RL 19-25		-	-
HUSQVARNA			
TC 125/250 14-25	520	48	1211-2827
FC 250/350/450 14-25		49	1211-2828
TE 150/250/300 14-25		50	1211-2829
FE 250/350/450 14-25		51	1211-2830
		52	1211-2831
KAWASAKI			
KX 125 94-08	520	49	1211-2819
KX 250 99-08		50	1211-2820
KX 250F 04-18		51	1211-2821
KX 250 19-25		-	-
KX 450F 06-18		-	-
KX 450 19-25		-	-
KLX 450R 08-15		-	-

FITS MODEL	CHAIN TYPE	SIZE	PART #
KTM			
SX 65 98-25		48	1211-2822
		50	1211-2823
SX 85 04-25		48	1211-2824
		49	1211-2825
		50	1211-2826
SX 125-300 93-25	520	48	1211-2827
SX-F 250-450 93-25		49	1211-2828
EXC 125-300 93-25		50	1211-2829
EXC-F 250-500 93-25		51	1211-2830
		52	1211-2831
STARK			
Varg 23-25	520	48	1211-2827
		49	1211-2828
		50	1211-2829
		51	1211-2830
		52	1211-2831
SUZUKI			
RM 125 92-08	520	48	1211-2832
RM 250 82-09		49	1211-2833
RM-Z 250 07-25		50	1211-2834
RM-Z 450 05-25		-	-
YAMAHA			
YZ 125/250 99-25	520	48	1211-2835
YZ 250F 01-25		49	1211-2836
YZ 450F 03-25		50	1211-2837
WR 250F/450F 03-25		51	1211-2838
		52	1211-2839



EXHAUST

LUGGAGE

BIKE STANDS & ACCESSORIES

HANDLEBARS & HAND CONTROLS

FOOTPEGS & FOOT CONTROLS

BODY

GRAPHICS & SEATS

SPROCKETS

CHAINS

BRAKES

WHEELS & ACCESSORIES

SUSPENSION

ELECTRICAL & GAUGES

LIGHTING

ENGINE

FUEL/AIR SYSTEMS

HARDWARE & MERCHANDISING



Steel



Aluminum



Rubber Cushioned



JT SPROCKETS

- Computer-designed to achieve ultimate strength at minimum weight
- JT combines leading-edge technology with top materials to produce the ultimate quality sprocket range with unbeatable value
- Every sprocket meets or exceeds the highest possible quality standards
- Sprockets are heat-treated and bead-blasted to reduce material surface tension
- Front sprockets made with top-quality SCM420 chromoly steel alloy
- Steel rear sprockets made with top-quality Japanese C49/C50 high carbon steel; available as noted with an induction-hardened black zinc finish - these sprockets are made from C45 high carbon steel with teeth that are heat-induction hardened to 38-50 HRC
- Aluminum rear sprockets are made with high-strength Austrian 7075-T6 anodized aluminum
- JT aluminum sprockets are about 30% lighter than a comparable steel equivalent, which reduces unsprung rotating weight and improves performance
- Lightweight front sprockets available for some applications
- For the full line of JT Sprockets see pages 620-677 of the 2024 Parts Europe Offroad catalog

RUBBER CUSHIONED FRONT SPROCKETS "RB"

- Used by the major Japanese motorcycle manufacturers since early 1990s to dampen the chain impact on the teeth of the front sprocket
- These same sprockets are now available to the aftermarket
- Quality, design and OEM proven technology are the same as what is supplied to the motorcycle manufacturers

SELF-CLEANING SPROCKETS "SC"

- Manufactured with self-cleaning grooves for added life and performance
- Made of stainless steel

RACELITE ALUMINUM REAR SPROCKETS

- JT sprockets is proud to introduce the new RaceLite range of anodized 7075-T6 aluminum sprockets
- Available in hard wearing color options, see fitment section for details

KEY TO NOTES:

- RB = Rubber cushioned.
- SC = Self-cleaning steel.
- ST = Steel.
- BLK = RaceLite black aluminum sprocket.
- BLU = RaceLite blue aluminum sprocket.
- GLD = RaceLite gold aluminum sprocket.
- RED = RaceLite red aluminum sprocket.

NOTE: When installing sprockets which differ from OEM sizes, check for proper clearances before operating.

FITS MODEL	STOCK GEARING	STOCK CHAIN	FRONT SIZE	PART #	NOTES	REAR SIZE	PART #	NOTES
BETA								
RR 125 LC 4T 21-23	14-63	520-114	14	1212-2336	ST	-	-	
RR 350 12	13-50	520-114	13	1212-1954	ST	-	-	
RR 400 10-12	13-50	520-114	14	1212-1955	ST			
RR 450 10-12	13-50	520-112						
RR 498 12	13-50	520-112						
RR 520 10-11	13-50	520-112						
GASGAS								
MC 85 17/14 22-25	13-46	428-124	-	-		49	1211-2852	RED
MC 85 19/16 BW 22-25	13-49	428-124						
MC 125 21-25	13-51	520-116	13	1212-2300	RB	40	1210-1714	BLK
MC 450F 21-25	13-49	520-118	14	1212-2301	RB	42	1210-1715	BLK
EC 250 21-25	14-52	520-118				45	JTR897-45	ST
						45	1210-1716	BLK
						48	1211-2854	RED
						49	1211-2856	RED
						50	1211-2858	RED
						51	1211-2860	RED
						52	1211-2862	RED



JT SPROCKETS (CONT)

FITS MODEL	STOCK GEARING	STOCK CHAIN	FRONT SIZE	PART #	NOTES	REAR SIZE	PART #	NOTES
HONDA								
CR 125R 04-07	13-52	520-116	13	1212-2290	ST	-	-	
CR 250R 88-91	14-51	520-116	13	1212-1965		-	-	
CR 250R 92-93	13-49	520-112						
CR 250R 94-95	13-49	520-114						
CR 250R 96-01	13-50	520-114						
CR 250R 02-05	13-48	520-114						
CR 250R 06-07	13-50	520-114						
CRF 125F 14-25	13-46	428-112	-	-		49	1210-1441	ST
CRF 125FB 15-25	13-49	428-118					-	
CRF 150R 07-25	15-50	420-120	15	1212-0546	SC	-	-	
CRF 150RB 07-25	15-56	420-126						
CRF 250R 04-09	13-51	520-	13	1212-2290	ST	-	-	
CRF 250R 10	13-48	520-116						
CRF 250R 11-17	13-49	520-116						
CRF 450R 02-03	13-50	520-114	13	1212-1965	ST	-	-	
CRF 450R 04-08	13-48	520-114						
CRF 450R 09-18	13-48	520-116						
CRF 450R 19-25	13-49	520-114						
HUSABERG								
TE 125 12-13	13-50	520-	13	1212-1954	ST	40	1210-1714	BLK
TE 250 11-13	13-50	520-118	14	1212-1955	ST	42	1210-1715	BLK
TE 300 11-13	13-50	520-118			ST	45	JTR897-45	ST
FE 350 13	13-52	520-			SC	45	1210-1716	BLK
FE 390 Enduro 10-12	13-52	520-118	13	1212-1954	ST	40	1210-1714	BLK
			14	1212-1955	ST	42	1210-1715	BLK
						45	JTR897-45	ST
						45	1210-1716	BLK
FE 450 Enduro 09-13	13-52	520-120	13	1212-1954	ST	40	1210-1714	BLK
			14	1212-1955	ST	42	1210-1715	BLK
						45	JTR897-45	ST
						45	1210-1716	BLK
FE 570 09-12	13-52	520-118	13	1212-1954	ST	40	1210-1714	BLK
			14	1212-1955	ST	42	1210-1715	BLK
						45	JTR897-45	ST
						45	1210-1716	BLK
HUSQVARNA								
TC 125 14-25	13-50	520-118	13	1212-1954	ST	40	1210-1714	BLK
FC 250 14-25	13-52	520-118	13	1212-2300	RB	42	1210-1715	BLK
FC 350 14-25	13-52	520-118	14	1212-1955	ST	45	JTR897-45	ST
FC 450 14-25	13-52	520-118	14	1212-2301	RB	45	1210-1716	BLK
TE 250 14-25	13-50	520-118			ST	48	1211-2853	BLU
TE 300 14-25	13-50	520-118			SC	49	1211-2855	BLU
FE 250 14-25	13-52	520-118			ST	50	1211-2857	BLU
FE 250 21-25	13-50	520-118			RB	51	1211-2859	BLU
FE 350 14-25	13-52	520-			RB	52	1211-2861	BLU
KAWASAKI								
KX 80G 86-87	13-49	420-120	-	-		50	1211-2844	BLK
KX 80J 87	13-54	420-126						
KX 80L 88	13-48	420-120						
KX 80L 89-90	13-49	420-120						
KX 80N 88-90	13-54	420-126						
KX 80R 91-97	13-49	420-118						
KX 80T 91-94	13-54	420-124						
KX 80 98-00	14-50	420-120						
KX 85 01-25	14-50	420-120	-	-		50	1211-2844	BLK
KX 85 BW 01-03	13-51	420-130						
KLX 140 08-20	13-51	428-126	13	1212-0751	ST	-	-	
			14	1212-0752	ST			
KX 250 99-01	13-48	520-114	12	1212-2292	ST	-	-	
KX 250 02-04	13-49	520-114	13	1212-2002	ST			
KX 250 05-08	13-51	520-114	14	1212-2302	RB			
			14	1212-2003	ST			
KX 250F 06-17	13-48	520-112	-	-		50	1211-2843	GLD
KX 250 18-25	13-50	520-114				51	1211-2809	GLD
KX 450/F 06-25	14-50	520-114	13	1212-1949	ST	50	1211-2843	
KLX 450R 08-21	13-50	520-114				51	1211-2809	GLD
KLX 300 03-07	14-50	520-110	13	1212-2002	ST	-	-	
			14	1212-2003	ST			

EXHAUST

LUGGAGE

BIKE STANDS & ACCESSORIES

HANDLEBARS & HAND CONTROLS

FOOTPEGS & FOOT CONTROLS

BODY

GRAPHICS & SEATS

SPROCKETS

CHAINS

BRAKES

WHEELS & ACCESSORIES

SUSPENSION

ELECTRICAL & GAUGES

LIGHTING

ENGINE

FUEL/AIR SYSTEMS

HARDWARE & MERCHANDISING

JT SPROCKETS continued on next page.



JT SPROCKETS (CONT)

	FITS MODEL	STOCK GEARING	STOCK CHAIN	FRONT SIZE	PART #	NOTES	REAR SIZE	PART #	NOTES
	KTM								
EXHAUST	SX 125 93-04	13-50	520-	13	1212-1954	ST	40	1210-1714	BLK
LUGGAGE	SX 125 05-15	13-50	520-118	13	1212-2300	RB	42	1210-1715	BLK
	SX 144 08	14-50	520-118	14	1212-1955	ST	45	JTR897-45	ST
	SX 150 08-15	14-50	520-120	14	1212-2301	RB	45	1210-1716	BLK
BIKE STANDS & ACCESSORIES	SX 150 12	13-48	520-						
	EXC 125 91-95	-	520-						
	EXC 125 91-03	13-50	520-						
	EXC 125 91-03	13-50	520-						
	EXC 125 04-10	14-42	520-						
HANDLEBARS & HAND CONTROLS	DXC 125 91-92	-	-						
	MX 125 91	13-50	520-118						
	MX 125 92	13-52	520-						
	SX 200 03-06	14-45	520-	13	1212-0546	ST	40	1210-1714	BLK
	EXC/MXC 200 99-05	14-48	520-	13	1212-2300	RB	42	1210-1715	BLK
	MXC 200 98	14-50	520-118	14	1212-1955	ST	45	JTR897-45	ST
FOOTPEGS & FOOT CONTROLS	MXC 200 99-04	14-48	520-	14	1212-2301	RB	45	1210-1716	BLK
	SX 250 93	14-50	520-116	13	1212-0546	ST	40	1210-1714	BLK
	SX 250 94	14-52	520-116	13	1212-2300	RB	42	1210-1715	BLK
	SX 250 95	13-50	520-116	14	1212-1955	ST	45	JTR897-45	ST
	SX 250 96-03	14-50	520-118	14	1212-2301	RB	45	1210-1716	BLK
BODY	SX 250 04/17-19	13-50	520-						
	SX 250 05-15	13-48	520-116						
	SX 250 20-25	14-49	520-						
	SX-F 250 06-12	13-48	520-118						
	SX-F 250 13-15	13-50	520-118						
GRAPHICS & SEATS	EXC 250 91-94	14-50	520-						
	EXC 250 95	13-50	520-						
	EXC 250 96-04	14-52	520-118						
	EXC 250 Racing 02	14-48	520-						
	DXC 250 90-91	15-50	520-						
SPROCKETS	MX 250 90-92	14-50	520-116						
	MXC 250 98-02	14-52	520-116						
	SX 300 93-95	14-50	520-116	13	1212-1954	ST	40	1210-1714	BLK
	EXC 300 90-93	14-50	520-	13	1212-2300	RB	42	1210-1715	BLK
	EXC 300 98/00-03	14-52	520-	14	1212-1955	ST	45	JTR897-45	ST
CHAINS	EXC 300 99/95-97	14-50	520-	14	1212-2301	RB	45	1210-1716	BLK
	EXC 300 99/95-97	14-50	520-						
	EXC 300 04	13-42	520-						
	DXC 300 90-92	15-50	520-116						
BRAKES	MX 300 86	-	520-						
	MX 300 90-91	14-48	520-116						
	MX 300 92	15-50	520-116						
	MXC 300 86	15-50	520-						
	MXC 300 93	14-48	520-116						
	MXC 300 94	14-50	520-116						
WHEELS & ACCESSORIES	MXC 300 95-03	14-52	520-116						
	MXC 300 03-05	13-50	520-						
	TXC 300 91-92	14-50	520-						
	SX-F 350 11-21	14-50	520-118	13	1212-1954	ST	40	1210-1714	BLK
SUSPENSION	EXC 350 13-20	14-45	520-118	13	1212-2300	RB	42	1210-1715	BLK
				14	1212-1955	ST	45	JTR897-45	ST
				14	1212-2301	RB	45	1210-1716	BLK
	SX 360 96-97	14-50	520-118	13	1212-1954	ST	40	1210-1714	BLK
	SX 380 98-02	14-50	520-	13	1212-2300	RB	42	1210-1715	BLK
	EXC 360 96	14-50	520-118	14	1212-1955	ST	45	JTR897-45	ST
ELECTRICAL & GAUGES	EXC 360 97	14-52	520-118	14	1212-2301	RB	45	1210-1716	BLK
	EXC/MXC 380 98-02	14-52	520-118						
	MXC 360 96-97	14-52	520-118						
	SX/MXC 400 99-02	14-50	520-	13	1212-1954	ST	40	1210-1714	BLK
	EXC 400 00	14-52	520-	13	1212-2300	RB	42	1210-1715	BLK
LIGHTING	EXC 400 01-02/05-06	14-50	520-	14	1212-1955	ST	45	JTR897-45	ST
				14	1212-2301	RB	45	1210-1716	BLK
	SX 440 94	13-50	520-	13	1212-1954	ST	40	1210-1714	BLK
	EXC 440 94-95	14-48	520-	13	1212-2300	RB	42	1210-1715	BLK
	MXC 440 94	14-48	520-	14	1212-1955	ST	45	JTR897-45	ST
ENGINE	MXC 440 95	14-50	520-	14	1212-2301	RB	45	1210-1716	BLK
	SX 450 03	14-50	520-	13	1212-1954	ST	40	1210-1714	BLK
	SX 450 04-06	14-52	520-	13	1212-2300	RB	42	1210-1715	BLK
	SX-F 450 07-13	14-52	520-116	14	1212-1955	ST	45	JTR897-45	ST
	SX-F 450 14-25	13-50	520-	14	1212-2301	RB	45	1210-1716	BLK
FUEL/AIR SYSTEMS	EXC 450 03-11	15-45	520-						
	MXC 450 03-05	14-50	520-						



JT SPROCKETS (CONT)

FITS MODEL	STOCK GEARING	STOCK CHAIN	FRONT SIZE	PART #	NOTES	REAR SIZE	PART #	NOTES
KTM (CONT)								
SX 500 95	14-50	520-	13	1212-1954	ST	40	1210-1714	BLK
EXC 500 92	-	520-	13	1212-2300	RB	42	1210-1715	BLK
EXC 500 12-15	15-45	520-118	14	1212-1955	ST	45	JTR897-45	ST
MX 500 92-93	14-50	520-116	14	1212-2301	RB	45	1210-1716	BLK
SX-F 505 07-09	14-52	520-	13	1212-1954	ST	40	1210-1714	BLK
	14-48	520-	13	1212-2300	RB	42	1210-1715	BLK
			14	1212-1955	ST	45	JTR897-45	ST
			14	1212-2301	RB	45	1210-1716	BLK
SX/MXC 520 99-02	14-48	520-	13	1212-1954	ST	40	1210-1714	BLK
	14-52	520-	13	1212-2300	RB	42	1210-1715	BLK
	14-48	520-	14	1212-1955	ST	45	JTR897-45	ST
EXC 520 01-02	14-48	520-	14	1212-2301	RB	45	1210-1716	BLK
			13	1212-1954	ST	40	1210-1714	BLK
			13	1212-2300	RB	42	1210-1715	BLK
			14	1212-1955	ST	45	JTR897-45	ST
SX 525 03-06	14-48	520-	13	1212-1954	ST	40	1210-1714	BLK
EXC 525 03-05	15-45	520-	13	1212-2300	RB	42	1210-1715	BLK
MXC 525 03-05	14-50	520-	14	1212-1955	ST	45	JTR897-45	ST
MXC 525 Racing 03-05	15-45	-	14	1212-2301	RB	45	1210-1716	BLK
DXC 550 92	14-48	520-	13	1212-1954	ST	40	1210-1714	BLK
MXC 550 93-96	14-48	520-118	13	1212-2300	RB	42	1210-1714	BLK
			14	1212-1955	ST	45	JTR897-45	ST
			14	1212-2301	RB	45	1210-1716	BLK
SUZUKI								
RM 80 86-01	13-52	428-116	-	-	-	46	1210-2760	ST
RM 85 02-23	13-50	428-118	-	-	-	46	1211-2848	BLU
			-	-	-	51	1210-2761	ST
			-	-	-	51	1211-2849	BLK
			-	-	-	52	1210-2783	BLK
YAMAHA								
YZ 65 18-25	14-47	420-114	14	1212-2291		47	1210-2777	ST
						47	1211-2841	BLK
YZ 85 02-25	14-47	428-118	-	-	-	46	1210-2760	ST
YZ 85 LW 02-18	14-52	428-	-	-	-	46	1211-2848	BLU
			-	-	-	51	1210-2761	ST
			-	-	-	51	1211-2849	BLK
			-	-	-	52	1210-2783	BLK
YZ 125 05-21	13-48	520-112	13	1212-1951	ST	-	-	
YZ 125 22-25	13-49	520-114	14	1212-1952	ST	-	-	
	13-48	520-114	-	-	-	-	-	
	13-50	520-114	-	-	-	-	-	
YZ 250 99-15	14-50	520-114	12	1212-2292	ST	-	-	
			13	1212-2002	ST	-	-	
			14	1212-2302	RB	-	-	
			14	1212-2003	ST	-	-	
YZ 250F 01-06	13-48	520-	12	1212-2292	ST	-	-	
YZ 250F 07-11	13-49	520-	13	1212-2002	ST	-	-	
YZ 250F 12-25	13-50	520-114	14	1212-2302	RB	-	-	
WR 250F 01-06	13-52	520-114	14	1212-2003	ST	-	-	
WR 250F 07-19	13-50	520-114	-	-	-	-	-	
WR 250F 20-23	13-51	520-114	-	-	-	-	-	
YZ 400F 98	14-49	520-114	12	1212-2292	ST	-	-	
			13	1212-2002	ST	-	-	
			14	1212-2302	RB	-	-	
			14	1212-2003	ST	-	-	
YZ/WR 426F 00-02	14-50	520-114	12	1212-2292	ST	-	-	
YZ 450F 03-04	14-48	520-114	13	1212-2002	SC	-	-	
YZ 450F 05-06	14-51	520-114	14	1212-2302	RB	-	-	
YZ 450F 07-25	13-49	520-114	14	1212-2003	ST	-	-	
WR 450F 03-06	14-50	520-114	-	-	-	-	-	
WR 450F 07-25	13-50	520-114	-	-	-	-	-	
IT 400 76	15-46	520-104	12	1212-2292	ST	-	-	
MX 400 75	14-50	520-106	13	1212-2002	ST	-	-	
YZ 400 76	14-50	520-106	14	1212-2302	RB	-	-	
			14	1212-2003	ST	-	-	
TT 500 76	15-52	520-100	12	1212-2292	ST	-	-	
TT 500 77-81	15-50	520-104	13	1212-2002	ST	-	-	
XT 500 76-81	16-44	520-100	14	1212-2302	RB	-	-	
			14	1212-2003	ST	-	-	

EXHAUST

LUGGAGE

BIKE STANDS & ACCESSORIES

HANDLEBARS & HAND CONTROLS

FOOTPEGS & FOOT CONTROLS

BODY

GRAPHICS & SEATS

SPROCKETS

CHAINS

BRAKES

WHEELS & ACCESSORIES

SUSPENSION

ELECTRICAL & GAUGES

LIGHTING

ENGINE

FUEL/AIR SYSTEMS

HARDWARE & MERCHANDISING



EXHAUST

LUGGAGE

BIKE STANDS & ACCESSORIES

HANDLEBARS & HAND CONTROLS

FOOTPEGS & FOOT CONTROLS

BODY

GRAPHICS & SEATS

SPROCKETS

CHAINS

BRAKES

WHEELS & ACCESSORIES

SUSPENSION

ELECTRICAL & GAUGES

LIGHTING

ENGINE

FUEL/AIR SYSTEMS

HARDWARE & MERCHANDISING

Moose Racing chain is made through an exclusive contract with a top European supplier. Moose Racing is in a state of constant development to bring you better chain at a competitive price. The recently developed FB technology is now proven. As the FB continues to impress, the development is paying dividends through the entire range of chains.

428 RXP PRO-MX CHAIN

- Non-O-ring chain
- Designed specifically for high-powered, mini-racing machines
- High application greased chain
- High-tensile strength nickel-plated inner link plates
- High-tensile rust-resistant gold-plated side plates
- Solid rollers
- Clip-type connecting link included
- Recommended for applications between 80/85 cc
- Replacement link available
- See pages 700-701 of the 2024 Parts Europe Offroad catalog for the complete line of Moose Racing chains

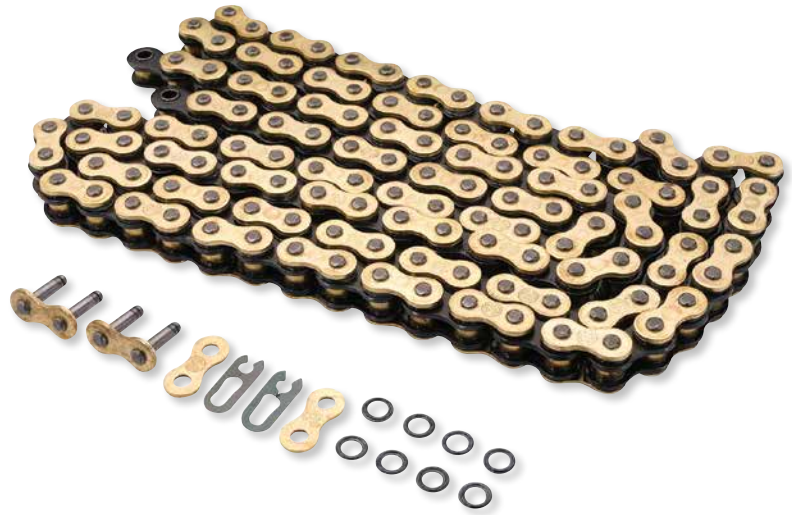

NO. OF LINKS	PART #
124	1222-0714

525 X-RING CHAINS

- Uses X shaped self lubricant seal allowing constant lubrication
- X-ring seals provides up to 7 times longer wear resistance than O-ring design
- Extra high-tensile strength link plates
- Rust-resistant gold-plated side plates
- Black inner and gold outer links
- Solid inner link and inner bushing
- Includes clip-type connecting link



NO. OF LINKS	PART #	NO. OF LINKS	PART #
118	1222-0715	124	1222-0716

O-RING CHAINS

- Uses O shaped self lubricating seal allowing constant lubrication
- Extra high-tensile strength link plates
- Rust-resistant gold-plated side plates
- Gold inner and outer links
- Solid roller inner link and inner bushing
- Includes clip-type connecting links



NO. OF LINKS	PART #	NO. OF LINKS	PART #
118	1222-0718	118	1222-0721
124	1222-0719	124	1222-0722



EK DEX SERIES CHAINS AND CONNECTING LINKS

- Economical QX-ring chain
- Features the Quadra X-Ring design which increases chain life from 1 1/2 to 2 times longer than a standard O-ring chain
- Replacement clip or rivet connecting links are available, sold separately
- See pages 706-707 of the 2024 Parts Europe Offroad catalog for the complete line of EK chains



520 CHAINS

LINKS	DEX
94	1223-1640
98	1223-1641
100	1223-1393
106	1223-1642

LINKS	DEX
108	1223-1643
110	1223-1394
112	1223-1644
114	1223-1645

LINKS	DEX
116	1223-1646
118	1223-1647
120	1223-1395

520 CONNECTING LINKS

DESCRIPTION	DEX
Clip link	1225-0751
Rivet link	1225-0555



1224-0120

Z-Ring "Spring effect"

520ZRE Z-RING CHAIN

- High-performance ZR chains with Z44 seal Z-ring sections
- Z-ring flexes when assembled, creating a spring effect that guarantees seal will not diminish over time
- Z-ring section also provides enhanced chain flexibility
- Features high-alloy steel plates and pins, solid bushings and rollers and shot-peened plates, pins and rollers
- Pre-stretched to enhance performance
- Clip-type and rivet-type links included
- Gold color
- See page 711 of the 2024 Parts Europe Offroad catalogue for the complete line of Regina 520ZRE chain

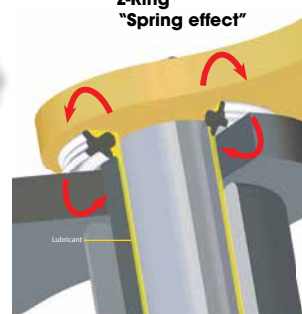

DESCRIPTION	PART #	DESCRIPTION	PART #
108 links	1224-0120	Rivet connecting link w/ hollow pin	1225-0755



DAI-HARD (DHA) SERIES NZ NON O-RING CHAIN

- D.I.D.'s professional high-performance non O-ring chain
- DHA pin treatment - hard chromium-carbide layer formed on pin surface
- Far better wear resistance than other chains
- Up to 19% higher tensile strength
- Increased antioxidation performance
- Solid bushings, quad-riveted pins
- Originally comes with clip connecting link
- See page 713 of the 2024 Parts Europe Offroad catalog for the complete line of D.I.D.'s Non O-ring Chains



SUPER NON O-RING SERIES - 428NZ

LINKS	COLOR	PART #
428NZ		
140	Gold	1221-0487

EXHAUST

LUGGAGE

BIKE STANDS & ACCESSORIES

HANDLEBARS & HAND CONTROLS

FOOTPEGS & FOOT CONTROLS

BODY

GRAPHICS & SEATS

SPROCKETS

CHAINS

BRAKES

WHEELS & ACCESSORIES

SUSPENSION

ELECTRICAL & GAUGES

LIGHTING

ENGINE

FUEL/AIR SYSTEMS

HARDWARE & MERCHANDISING

EXHAUST

LUGGAGE

BIKE STANDS & ACCESSORIES

HANDLEBARS & HAND CONTROLS

FOOTPEGS & FOOT CONTROLS

BODY

GRAPHICS & SEATS

SPROCKETS

CHAINS

BRAKES

WHEELS & ACCESSORIES

SUSPENSION

ELECTRICAL & GAUGES

LIGHTING

ENGINE

FUEL/AIR SYSTEMS

HARDWARE & MERCHANDISING



XRE (XW-RING) LIGHTWEIGHT HIGH PERFORMANCE CHAIN

- Ideal for OEM replacement of mid-size motorcycle
- Lightweight and durable chain provides quick and smooth acceleration
- Designed with cutting edge technology from various on-road and off-road racing
- RK's original double-X-shaped "XW-Ring" seal provides exceptionally long chain wear-life

- 428XRE tensile strength of 2753 kg (6.070 lbs) and maximum of 400 cc
- 520XRE tensile strength of 3719 kg (8.200 lbs) and maximum of 800 cc

428XRE (NATURAL) - CUT-TO-LENGTH

NO. OF LINKS	428XRE PART #	NO. OF LINKS	428XRE PART #
120	1223-1958	134	1223-1962
124	1223-1959	136	1223-1963
128	1223-1960	140	1223-1964
130	1223-1961	142	1223-1965

NO. OF LINKS	428XRE PART #
146	1223-1966
Clip connecting link	1223-1957

520XRE (NATURAL) - CUT-TO-LENGTH

NO. OF LINKS	520XRE PART #	NO. OF LINKS	520XRE PART #
106	1223-1967	116	1223-1971
110	1223-1968	118	1223-1972
112	1223-1969	120	1223-1973
114	1223-1970	124	1223-1974

NO. OF LINKS	520XRE PART #
130	1223-1975
Clip connecting link	1225-0839
Rivet connecting link	1225-0840

GB520XRE (GOLD COLOR) - CUT-TO-LENGTH

NO. OF LINKS	GB520XRE PART #	NO. OF LINKS	GB520XRE PART #
106	1223-1976	116	1223-1980
110	1223-1977	118	1223-1981
112	1223-1978	120	1223-1982
114	1223-1979	124	1223-1983

NO. OF LINKS	GB520XRE PART #
130	1223-1984
Clip connecting link	1225-0841
Rivet connecting link	1225-0842

1221 0326



HEAVY-DUTY STANDARD CHAIN (H)

- Non-Sealed economical chain for heavy-duty usage, improved strength compare to standard chains
- Manufactured from carbon alloy steel, heat-treated and shot-peened for maximum strength and durability
- Pre-stressed and pre-stretched for superior performance and minimize elongation during the life of the chain
- Excellent quality and cost performance for heavy-duty motorcycle application

- Includes clip connecting link
- 520 H Tensile strength 3493 kg (7.700 lbs)
- See page 714 of the 2024 Parts Europe Offroad catalogue for the complete line of RK Heavy-Duty Standard Chain

520 H

LINKS	H (NATURAL) PART #	H (GOLD) PART #	LINKS	H (NATURAL) PART #	H (GOLD) PART #
70	1221-0326	-	92	1221-0329	1221-0338
78	1221-0327	-			

1225-0847



GP CHAIN CLIP-TYPE CONNECTING LINKS

- Designed for the toughest conditions in professional motocross racing
- Pins are hard chromed which significantly increases lifespan in wet and muddy conditions
- See page 709 of the 2024 Parts Europe Offroad catalog for the complete line of Moto-Master chains and connecting links

DESCRIPTION	PART #	DESCRIPTION	PART #
420 GP clip-type connecting link	1225-0847	520 GP clip-type connecting link	1225-0714
428 GP clip-type connecting link	1225-0848		



OEM CHAIN ROLLERS

- Reduce the friction dragging down your drivetrain
- Polyurethane roller with 98A durometer hardness for long life
- Precision contact sealed bearings keep water and dirt away

DESCRIPTION	PART #	DESCRIPTION	PART #	DESCRIPTION	PART #
HONDA		KAWASAKI		UNIVERSAL	
34 mm	1231-1569	38 mm	1231-1572	32 mm	1231-1573
38 mm	1231-1570	KTM		38 mm	1231-1574
		34 mm	1231-1571		

1231-1569



COLORED CHAIN GUIDES

- Outer anodized plates made of CNC-machined 6061 aluminum
- 3D designed inner slider to help in not allowing buildup of debris around chain that may cause chain to derail
- TPU inner guide material provides perfect wear resistance for chain to ride on along with minimizing wear to the chain block
- TPU compound helps reducing load on swingarm and mounting brackets of chain guide due to impacts
- High-quality anodizing helps prevent fading in high UV climates

FITS MODEL	COLOR	PART #
HUSQVARNA		
TC 125/250 23-25	Orange	1231-1727



- Replacement inner guide sold separately
- See page 727 of the 2024 Parts Europe Offroad catalog for the complete line of Moose Racing Colored Chain Guides

FITS MODEL	COLOR	PART #
HUSQVARNA (CONT)		
FC 250/350/450 23-25	Orange	1231-1727



CHAIN GUIDES

- Made of reinforced polyethylene plastic
- It's designed in two parts, which allows it to be installed and dismantled without opening the chain
- The material used offers better resistance to obstacles and also a better durability

CHAIN GUIDES

FITS MODEL	COLOR	PART #
BETA		
RR 2T/4T 125/200/250/300/350/390/430/480/500 20-23	Black	1231-1675
	Red	1231-1676
GASGAS		
MC 125/250 24-25	Black	1231-1685
MC 250F/450F 21-23	Black	1231-1678
MC 250F/350F/450F 24-25	Black	1231-1685
EC 250/300 21-23	Black	1231-1678
EC 250/300 24-25	Black	1231-1685
EC 250F/350F 21-23	Black	1231-1678
EC 250F/350F 24-25	Black	1231-1685
HONDA		
CRF 250R/RX 07-25	Black	1231-1683
CRF 450R/RX/L/RL/X 07-25	Black	1231-1683
CRF 250L/300L/Rally 13-23	Black	1231-1677
HUSQVARNA		
TC 125/250 14-22	Black	1231-1678
TC 125/250 23-25	Black	1231-1685
	Blue	1231-1688
FC 250/350/450 14-22	Black	1231-1678
FC 250/350/450 23-25	Black	1231-1685
	Blue	1231-1688
TE 125/250 14-23	Black	1231-1678
TE 150/250/300 24-25	Black	1231-1685
	Blue	1231-1688
FE 250/350/450/501 14-23	Black	1231-1678
FE 250/350/450/501 24-25	Black	1231-1685
	Blue	1231-1688
KAWASAKI		
KX 250/450 19-24	Black	1231-1689



1231-1675



1231-1690



FITS MODEL	COLOR	PART #
KTM		
SX 125/250 16-22	Black	1231-1678
SX 125/250/300 23-25	Black	1231-1685
	Orange	1231-1686
SX-F 250/350/450 16-22	Black	1231-1678
EXC-F 150/250/300 24-25	Black	1231-1685
	Orange	1231-1686
EXC 250/300 16-22	Black	1231-1678
EXC-F 250/350/450/500 16-22	Black	1231-1678
EXC-F 250/350/450/500 24-25	Black	1231-1685
	Orange	1231-1686
RIEJU		
MIR PRO 22-24 (all)	Black	1231-1678
	Blue	1231-1679
SHERCO		
SC 250/300 Factory 12-23	Black	1231-1678
	Blue	1231-1679
SCF 250/300 Factory 12-23	Black	1231-1678
	Blue	1231-1679
SCF 250/300 24-25	Black	1231-1730
	Blue	1231-1731
SE 125/250/300/300 Factory/Racing 24-25	Black	1231-1730
	Blue	1231-1731
SE 250/300 Factory/Racing 12-23	Black	1231-1678
	Blue	1231-1679
SEF 250/300 Factory/Racing 12-23	Black	1231-1678
	Blue	1231-1679
SEF 250/300/450/500 Factory 24-25	Black	1231-1730
	Blue	1231-1731

CHAIN GUIDES continued on next page.

EXHAUST

LUGGAGE

BIKE STANDS & ACCESSORIES

HANDLEBARS & HAND CONTROLS

FOOTPEGS & FOOT CONTROLS

BODY

GRAPHICS & SEATS

SPROCKETS

CHAINS

BRAKES

WHEELS & ACCESSORIES

SUSPENSION

ELECTRICAL & GAUGES

LIGHTING

ENGINE

FUEL/AIR SYSTEMS

HARDWARE & MERCHANDISING

EXHAUST

LUGGAGE

BIKE STANDS & ACCESSORIES

HANDLEBARS & HAND CONTROLS

FOOTPEGS & FOOT CONTROLS

BODY

GRAPHICS & SEATS

SPROCKETS

CHAINS

BRAKES

WHEELS & ACCESSORIES

SUSPENSION

ELECTRICAL & GAUGES

LIGHTING

ENGINE

FUEL/AIR SYSTEMS

HARDWARE & MERCHANDISING



CHAIN GUIDES (CONT)

CHAIN GUIDES (CONT)

FITS MODEL	COLOR	PART #
YAMAHA		
YZ 125/250 07-22	Black	1231-1728
YZ 250F/450F 07-23	Black	1231-1728
YZ 250F/450F 24-25	Black	1231-1729
WR 250 16	Black	1231-1728

REPLACEMENT CHAIN GUIDE PAD

FITS MODEL	COLOR	PART #
GASGAS		
MC 250F/450F, EC 250/300/250F/350F 21-23	Black	1231-1690
HUSQVARNA		
TC 125/250, FC 250/350/450, TE 125/250, FE 250/350/450/501 14-22	Black	1231-1690

FITS MODEL	COLOR	PART #
YAMAHA (CONT)		
WR 250F 07-22	Black	1231-1728
WR 450F 07-21	Black	1231-1728
WR 450F 24-25	Black	1231-1729

FITS MODEL	COLOR	PART #
KTM		
SX 125/250, SX-F 250/350/450, EXC 250/300, EXC-F 250/350/450/500 16-22	Black	1231-1690
SHERCO		
SC/SCF 250/300 Factory, SE/SEF 250/300 Factory/Racing 12-23	Black	1231-1690



AXLE BLOCKS

- CNC machined for precise axle alignment
- Reverse and forward positions
- Anodized black finish for durability
- Sold in pairs
- See page 729 of the 2024 Parts Europe Offroad catalog for the complete line of SCAR axle blocks



FITS MODEL	PART #
GASGAS	
MC 125/250/250F/350F/450F 24-25	1731-0788
EC 250/300/250F/350F/450F/500F 24-25	1731-0788
HUSQVARNA	
TC 125/250 23-25, TE 150/250/300 24-25	1731-0788
FC 250/350/450 23-25, FE 250/350/450/501 24-25	1731-0788

FITS MODEL	PART #
KTM	
SX 125/250/300, SX-F 250/350/450 23-25	1731-0788
EXC 250/300, EXC-F 250/350/500 24-25	1731-0788



TRACK WRENCHES

- 4-in-1 lightweight billet aluminum axle wrench with indexable multi tool

WRENCH SIZES

DESCRIPTION	PART #
17, 27, 30 mm and 13/16" (2-stroke spark plug insert)	3812-0723
17, 27, 32 mm and 13/16" (2-stroke spark plug insert)	3812-0780

DESCRIPTION	PART #
22, 27, 30 mm and 13/16" (2-stroke spark plug insert)	3812-0781

APPLICATIONS

FITS MODEL	PART #
GASGAS	
MC 85 21-24, MC 125 21-23, MC 250 22-23, MC 250F 21-23, MC 350F 22-23, MC 450F 21-23	3812-0780
MC 125/250/250F/250F Factory Edition/350F/450F/450F Factory Edition 24-25, MC 150/300 25	3812-0723
EC 250/300 24-25, EC 250F 24, EC 450F 24-25	3812-0723
EC 300 21-23	3812-0780
HUSABERG	
125-501 11-14 (all)	3812-0780
HUSQVARNA	
TC 65 14-19, TC 85 14-19/21-22, TC 125 14-22, TC 250 02-22, TC 310 12-14	3812-0780
TC 125/250 23-25, TC 150/300 25	3812-0723
FC 250/350/450 14-22	3812-0780
FC 250/350/450 23-25	3812-0723
TE 125 14-19, TE 150 17-22, TE 250 11-22, TE 300 19-22, TE 310 09-12, 14, TE 350 95-97	3812-0780
TE 150/250/300 24-25 (all)	3812-0723
FE 250/350/450/501 14-22	3812-0780
FE 250 24, FE 350/450/501 24-25	3812-0723
TXC 250 08-14, TXC 310 12-14, TXC 511 11-12	3812-0780
WR 125 95-14, WR 250 95-13, WR 300 09-16	3812-0780
KTM	
SX 65 98-22, SX 85 03-22, SX 105 04-12	3812-0780
SX 125 94-22, SX 144 07-08, SX 150 08-22, SX 200 03-04, SX 250 94-22	3812-0780

FITS MODEL	PART #
KTM (CONT)	
SX 125/250/300 23-25, SX 150 25	3812-0723
SX 525 03-07, SX-F 250 05-22, SX-F 350 11-22, SX-F 450 03-22, SX-F Factory Edition 450 12-18/20	3812-0780
SX-F 250/450 Factory Edition 22, 250/350/450 23-25	3812-0723
SX-F 505 08-10, EXC 520/525/530 00-17 (all)	3812-0780
EXC 125 94-19, EXC 150 TPI 20-23, EXC/Six Days 250/350 94-22	3812-0780
EXC 250/300/Six Days/Hardenduro 24-25	3812-0723
EXC-F 250/Six Days 06-07/17-22, 350/500/Six Days 12-22, 450/Six Days 09/17-22	3812-0780
EXC-F 250/350/450/500/Six Days 24-25	3812-0723
Freeride 350 16-18	3812-0780
SHERCO	
SC 125 19-20, SE 125 Factory 21-23, SE-R 125 17-21	3812-0781
SC/SCF 250 17-20, SE/SEF 250 Factory 14-23, SE-R 250 14-22, SEF-R 250 15-22	3812-0781
SC 300 17-20, SCF 300 17/19-20, SE 300 Factory 14-23, SE-R 300 14-22, SEF 300 Factory 13-23, SEF-R 300 13-22	3812-0781
SCF 450 19-20, SEF 450 Factory 21-23, SEF-R 450 15-22	3812-0781
SCF 500 19-20, SEF 500 Factory 19-23	3812-0781
YAMAHA	
YZ 125 98-24, YZ 125X 20-24, YZ 250 74-24, YZ 250X 16-24	3812-0781
YZ 250F 98-24, YZ 426F 00-02, YZ 450F 03-24, YZ 450FX 16-24	3812-0781
WR 250F 98-24	3812-0781



3812-0723



XCR REAR BRAKE PADS BY DP BRAKES

- Manufactured for Moose Racing by the originators of sintered brake technology, DP Brakes
- Trusted by top riders worldwide, these top quality pads are offered in two compounds to fit your needs
- Ultimate wet condition pads
- Low-wear S-47 sintered metal compound outlasts the gnarliest conditions
- High-tech gray zirconium-based ceramic applied extra thick to protect brake fluid from heat
- Perfect match with Moose Racing OEM-replacement or Mud-Proof Solid replacement rotors
- See pages 732-742 of the 2024 Parts Europe Offroad catalog for Moose Racing's complete line of brake pads and shoes by DP Brakes



M622-S47

FITS MODEL	PART #	FITS MODEL	PART #	FITS MODEL	PART #
ATK		BMW (CONT)		HUSQVARNA	
All models 96-04	M622-S47	F900GS 24	M622-S47	All models 95-03	M622-S47
BMW		G650GS 12-16	M622-S47	WR 300 09-13	M622-S47
F650GS 01-12	M622-S47	GASGAS		KTM	
F700GS 13-17	M622-S47	All 95-99	M622-S47	All models 94-02 (except SX 50/65)	M622-S47
F750GS 18-23	M622-S47	RX 450F Rally Replica 23-24	M622-S47	All models 03 (except SX 250/450)	M622-S47
F800GS /Adventure 08-18	M622-S47	HUSABERG		TM	
F850GS 18-23	M622-S47	All 95-07	M622-S47	MX/Enduro 80/125/250 94-00	M622-S47



NITRO BRAKE PADS

- Sintered metal pads offer a powerful initial bite and optimal wear resistance in extreme conditions
- They provide a progressive feel at the lever and offer high thermal stability up to 600 °C/1000 °F degrees; no fading on high-speed downhills
- 100% compatible with OEM stainless steel rotors, but are designed especially to match Moto-Master brake rotors in performance and feeling
- Bedding-in time is low as optimal pad/disc contact is achieved after eight to 10 stops
- Racing pads offer quicker bedding in times and stronger initial bite
- Racing GP pads are optimized for racing with maximum bite, and supreme temperature resistance
- Fit both front and rear for listed applications



FITS MODEL	NITRO PART #	NITRO RACING PART #	NITRO RACING GP PART #	FITS MODEL	NITRO PART #	NITRO RACING PART #	NITRO RACING GP PART #
GASGAS				KTM			
MC-E 3 23-25, MC-E 5 24-25	1721-3620	1721-3622	1721-3621	SX 50 24-25	1721-3620	1721-3622	1721-3621
HUSQVARNA				SX-E 3 23-25, SX-E 5 24-25	1721-3620	1721-3622	1721-3621
TC 50 24-25	1721-3620	1721-3622	1721-3621				
EE 3 23-25, EE 5 24-25	1721-3620	1721-3622	1721-3621				



BRAKE PADS

CERAMIC BRAKE PADS (HF)

- Replacement pad compound for motorcycles with non-sintered pads
- Ceramic compound offers long pad life, low dust and low brake disc/rotor wear
- Consistent performance in wet or dry conditions
- NUCAP NRS technology secures a mechanical, indestructible bonding of the pad compound
- Noise reduction technology for high comfort and low development of noise

RACING SINTERED BRAKE PADS (RST)

- Performance upgrade choice of MXGP FIM Motocross World Championship teams and riders
- Sintered compound formulated for high thermal stability, powerful and predictable fade-free performance
- Compatible with OEM standard brake discs and specially designed racing discs
- NUCAP NRS technology secures a mechanical, indestructible bonding of the pad compound
- See pages 761-793 of the 2024 Parts Europe Offroad catalog for the complete line of SBS brake pads



1720-1149



1721-3566

FITS MODEL	MOUNT LOCATION	COMPOUND	PART #
KTM			
MX250/350/550, 400 Enduro 87-90	F/R	HF	1720-1149
		RST	1721-3566

EXHAUST

LUGGAGE

BIKE STANDS & ACCESSORIES

HANDLEBARS & HAND CONTROLS

FOOTPEGS & FOOT CONTROLS

BODY

GRAPHICS & SEATS

SPROCKETS

CHAINS

BRAKES

WHEELS & ACCESSORIES

SUSPENSION

ELECTRICAL & GAUGES

LIGHTING

ENGINE

FUEL/AIR SYSTEMS

HARDWARE & MERCHANDISING

BRAKES

EXHAUST

LUGGAGE

BIKE STANDS & ACCESSORIES

HANDLEBARS & HAND CONTROLS

FOOTPEGS & FOOT CONTROLS

BODY

GRAPHICS & SEATS

SPROCKETS

CHAINS

BRAKES

WHEELS & ACCESSORIES

SUSPENSION

ELECTRICAL & GAUGES

LIGHTING

ENGINE

FUEL/AIR SYSTEMS

HARDWARE & MERCHANDISING



1721-3547



1721-3563



BRAKE PADS

SEMI-METALLIC/ORGANIC (1054)

- Great feel and modulation for OEM replacement
- Long lasting and very little rotor wear
- Good in wet and/or dry conditions
- Overall, a very versatile compound for almost every need

- GG friction rated
- See pages 755-760 of the 2024 Parts Europe Offroad catalog for the complete line of Galfer brake pads

FITS MODEL	FRONT PAD PART #	REAR PAD PART #
BETA		
REV 3 80/125/200/250/270 04-08	-	1721-3563
REV 4T 250 07-08	-	1721-3563
EVO 125/250 2T/300 2T/300 4T	1721-3547	-
EVO 80 Junior 09	-	1721-3563
RX 300 24-25	1721-2977	1721-3564
RX 450 24-25	1721-2977	1721-3564
RR 50/125/200 08-20	-	1721-3564
RR 200 20	-	1721-3564
RR 350 11-13	1721-2977	-
RR 390/430/480 15	1721-2977	1721-3564
RR 400 05-12	1721-2977	-
RR 450 05-13	1721-2977	-
RR 498 12-13	1721-2977	-
RR 525 05	1721-2977	-
ALP X 300 24-25	-	-
ALP X 350 24-25	-	1721-3564
Xtrainer 250 18	-	1721-3564
Xtrainer 300 15	-	1721-3564
GASGAS		
MC 50/65 06-20	-	1721-3559
MC 50 21-23	1721-2400	1721-2400
MC 125 01-20	1721-2977	-
MC 250 01-15	1721-2977	-
EC 125 01-20	1721-2977	-
EC 200 01	1721-2977	-
EC 250 01-20	1721-2977	-
EC 300 01-20	1721-2977	-
EC 450F 15	1721-2977	-
Trial GP 125/250/280/300 19	1721-3547	1721-3559
HONDA		
CR 80R 97-02	1721-2972	1721-2976
CR 85R 03-07	1721-2972	1721-2976
CR 125R 84-86	1721-3537	-
CR 125R 87-93	-	1721-2976
CR 125R 94-01	1721-2977	1721-2976

FITS MODEL	FRONT PAD PART #	REAR PAD PART #
HONDA (CONT)		
CR 125R 02-07	1721-2977	1721-2978
CR 250R 84-86	1721-3537	-
CR 250R 87-91	-	1721-2976
CR 250R 92-01	1721-2977	1721-2976
CR 250R 02-07	1721-2977	1721-2978
CR 500R 84	1721-3537	-
CR 500R 85-00	1721-2977	1721-2976
CRF 150F 03-06	1721-2977	-
CRF 150R 07-23	1721-2972	1721-2978
CRF 230L/M 08-09	1721-2977	1721-2978
CRF 250R 04-25	1721-2977	1721-2978
CRF 450F/LJ/R/X 01-23	1721-2977	1721-2978
HUSQVARNA		
TE 50 18-25	1721-2400	1721-2400
TE 610 92-94	1721-2973	-
KAWASAKI		
KX 60 94	1721-2973	-
KX 125 89-94	1721-2973	-
KX 125 95-06	1721-2977	1721-2976
KX 250 89-93	1721-2973	-
KX 250 95-03	1721-2977	1721-2976
KX 250F 04-25	1721-2977	-
KX 450F 06-25	1721-2977	-
KX 500 89-93	1721-2973	-
KX 500 94	1721-2977	-
KX 500 95	1721-2977	1721-2976
KLX 125 10	1721-2973	-
KLX 140 08	1721-2973	-
KLX 230 21-22	1721-2973	-
KLX 250 09	1721-2973	1721-2976
KLX 300 96-20	1721-2977	1721-2976
KLX 400 03	1721-2977	-
KLX 400 21-24	1721-2973	-
KLX 450 07	1721-2977	-
KLX 650 93	1721-2977	-
KTM		
SX 50 06-23	1721-2400	1721-2400

FITS MODEL	FRONT PAD PART #	REAR PAD PART #
SHERCO		
ST 250/290/300/305	-	1721-3559
SUZUKI		
RM 125 87-95	1721-2973	-
RM 125 96-03	1721-2977	1721-2976
RM 125 04-06	1721-2977	-
RM 250 93-95	1721-2973	1721-2397
RM 250 96-06	1721-2977	1721-2976
RM-Z 250 04-19	1721-2977	-
RM-Z 450 18-25	1721-2977	-
DR 350 90-94	-	1721-2397
DR 650 96	1721-2977	1721-2397
DR-Z 250 01	1721-2977	1721-2976
DR-Z 400 00	1721-2977	1721-2976
YAMAHA		
YZ 125 88	-	1721-3557
YZ 125 90-97	1721-2973	1721-2397
YZ 125 98-02	1721-2977	1721-2976
YZ 125 03-07	1721-2977	-
YZ 250 92-98	1721-2973	1721-2397
YZ 250 99-02	1721-2977	1721-2976
YZ 250F 03-06	1721-2977	-
YZ 360 89	1721-2973	-
YZ 400F 98-99	1721-2977	1721-2976
YZ 426F 00-02	1721-2977	1721-2976
YZ 450F 03-07	1721-2977	-
WR 125 91-97	1721-2973	1721-2397
WR 125 98-02	1721-2977	1721-2976
WR 125 03-07	1721-2977	-
WR 200R 93	1721-2973	1721-2397
WR 250 89-98	1721-2973	1721-2397
WR 250 99-02	1721-2977	1721-2976
WR 250F 03-16	1721-2977	-
WR 400 98-99	1721-2977	1721-2976
WR 426 00-02	1721-2977	1721-2976
WR 450F 03-15	1721-2977	-
WR 500 92	1721-2973	1721-2397



DISC BRAKE PADS

TRQ TRACK RACING QUALITY BRAKE PADS

- Designed for maximum track performance while being street legal; enjoy a full day on the track and ride home on the same bike
- ONLY use for FRONT brake caliper
- Higher, more stable friction coefficient for greater braking performance
- Optimized direct response characteristics

- Innovative sintering process for exceptional thermal resistance
- Low pad and disc wear
- See pages 794-802 of the 2024 Parts Europe Offroad catalog for the complete line of TRW brake pads

FITS MODEL	FRONT BRAKE PAD PART #
GASGAS	
EC 400 FSE 02-03	1721-3174
FSR 450 07-08	1721-3174
SM 450 03-05	1721-3174

FITS MODEL	FRONT BRAKE PAD PART #
HUSQVARNA	
SM 450R 03-04	1721-3174
SMR 630 06-07	1721-3174
KTM	
LC4 640 E 03	1721-3174

FITS MODEL	FRONT BRAKE PAD PART #
KTM (CONT)	
SMC 660 03-04	1721-3174
SACHS	
X-Road 125 07	1721-3174

EXHAUST

LUGGAGE

BIKE STANDS & ACCESSORIES

HANDLEBARS & HAND CONTROLS

FOOTPEGS & FOOT CONTROLS

BODY

GRAPHICS & SEATS

SPROCKETS

CHAINS

BRAKES

WHEELS & ACCESSORIES

SUSPENSION

ELECTRICAL & GAUGES

LIGHTING

ENGINE

FUEL/AIR SYSTEMS

HARDWARE & MERCHANDISING



See chart for details



1721-3573



1721-3574

DP BRAKES

DP PRO MX HIGH-PERFORMANCE BRAKE PADS

- Developed by Pro Factory riders
- High-performance HH-rated friction material
- Equally adept in wet or dry conditions
- No brake fade
- Excellent initial response and quick break-in
- Provides a competitive edge under all conditions
- Gray, state-of-the-art zirconium-based ceramic material on backplate works as a heat shield in maximum-stress race conditions
- DP PRO MX pads are available in a limited number of fitments
- MX Sport recommended for all motocross racing and competitive enduro use

FITS MODEL	FRONT BRAKE PAD PART #	REAR BRAKE PAD PART #
GASGAS		
MC 65 23-25	1721-3573	1721-3573
HUSQVARNA		
EE 5 20-25	1721-3574	1721-3574
SM 50 1-12	1721-3574	1721-3574
TC 50 17-23	1721-3574	1721-3574
TC 50 Mini 19-23	1721-3574	1721-3574
CR 50 11-12	1721-3574	1721-3574
TC 65 23-25	1721-3573	1721-3573

DP SINTERED METAL BRAKE PADS

- GG friction material
- Equal performance in wet or dry conditions; no brake fade
- Ideal replacement on off-road bikes where durability is the prime requirement
- Gray aluminum oxide-based ceramic material on rear of backplate works as a heat shield in high-stress conditions

FITS MODEL	FRONT BRAKE PAD PART #	REAR BRAKE PAD PART #
KTM		
SX 50/Factory 10-23	1721-3574	1721-3574
SX 50 Junior 06-08	1721-3574	-
SX 50 Pro Junior LC 02-03	1721-3574	-
SX 50 Pro Senior LC 02-05	1721-3574	1721-3574
SX 50 Senior Adventure 03-07	1721-3574	-
SX 65 04-08	-	1721-3574
SX 65 23-25	1721-3573	1721-3573



BRAKE SHOES

"G" GROOVED BRAKE SHOES

- All the features of EBC standard brake shoes, plus multiple-angle liner grooves designed to channel away dirt, dust, water and debris from the braking surface area to improve performance and extend drum and shoe life
- See pages 806-849 of the 2024 Parts Europe Offroad catalog for additional EBC brake pad and shoe applications

FITS MODEL	FRONT PAD/SHOE COMPOUND TYPE	FRONT PAD/SHOE PART #	REAR PAD/SHOE COMPOUND TYPE	REAR PAD/SHOE PART #
HUSQVARNA				
CR 125/240/250/500 82-84	Grooved shoe	1723-0574	-	-
WR 125R/240/250 82-84	Grooved shoe	1723-0574	-	-
XC 125/250/500 82-84	Grooved shoe	1723-0574	-	-
WR-E/WRU 430 82-84	Grooved shoe	1723-0574	-	-
AE 500 82-84	Grooved shoe	1723-0574	-	-
KTM				
250/350/495 82	-	-	Grooved shoe	1723-0573
350 4-stroke 83	-	-	Grooved shoe	1723-0573
MX 250/495 Leleu 82	-	-	Grooved shoe	1723-0573
XC/GS 250 83	-	-	Grooved shoe	1723-0573



EXHAUST

LUGGAGE

BIKE STANDS & ACCESSORIES

HANDLEBARS & HAND CONTROLS

FOOTPEGS & FOOT CONTROLS

BODY

GRAPHICS & SEATS

SPROCKETS

CHAINS

BRAKES

WHEELS & ACCESSORIES

SUSPENSION

ELECTRICAL & GAUGES

LIGHTING

ENGINE

FUEL/AIR SYSTEMS

HARDWARE & MERCHANDISING



MUD-PROOF SOLID REAR DISC ROTOR

- Used by professional off-road racing teams around the world
- Made from high-carbon content stainless steel, which offers greater friction than standard discs
- No-holes design greatly prolongs brake pad life in muddy conditions
- Cut with a CAD/CAM laser machine, not stamped like stockers
- Perfect for muddy conditions, off-road or on the track



FITS MODEL	PART #	FITS MODEL	PART #	FITS MODEL	PART #
YAMAHA		YAMAHA (CONT)		YAMAHA (CONT)	
YZ 125/250 02-25	1711-2253	YZ 250FX 17-25	1711-2253	YZ 125X 20-25	1711-2253
YZ 250F 01-25	1711-2253	YZ 250X 19-25	1711-2253		

1711-2250

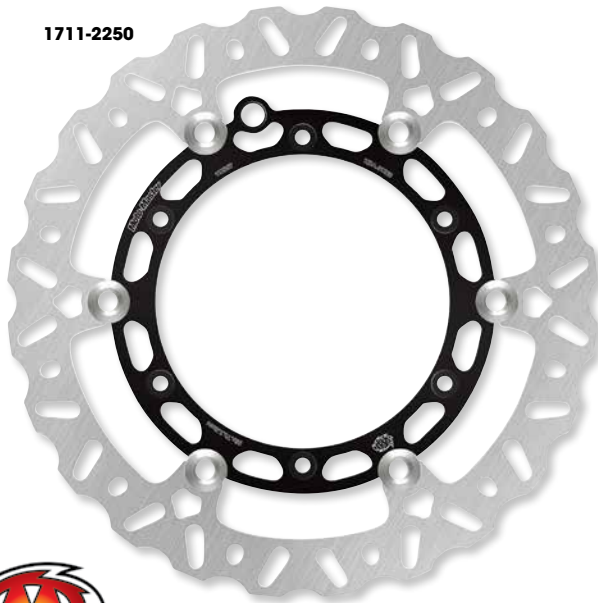

1711-2251

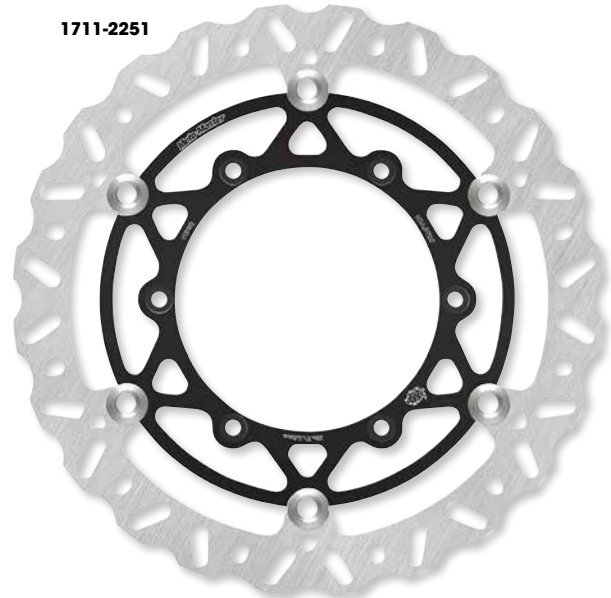

NITRO MX FLOATING FRONT BRAKE DISCS

- Serious performance upgrade at a reasonable cost
- Outperform OEM fixed rotors
- Durable stainless steel outer ring and floaters, coupled with a lightweight aluminum core
- Simple installation with no relocation bracket required

FITS MODEL	PART #	FITS MODEL	PART #	FITS MODEL	PART #
BIMOTA		HUSQVARNA (CONT)		KTM (CONT)	
BX 450 24-25	1711-2250	TE 300 14-25	1711-2252	EXC 450 02-16	1711-2252
FANTIC		FE 250/350/450/501 14-25	1711-2252	EXC 500 12-16	1711-2252
XX 125 21-25	1711-2251	KAWASAKI		EXC-F 250 99-25	1711-2252
XX/XXF 250 22-25	1711-2251	KX 250F/X 15-25	1711-2250	EXC-F 350 12-25	1711-2252
XXF 450 22-25	1711-2251	KX 450F/X 15-25	1711-2250	EXC-F 450 16-25	1711-2252
XE 125 22-25	1711-2251	KTM		EXC-F 500 17-25	1711-2252
GASGAS		SX 125 89-25	1711-2252	STARK	
EC 250 24-25	1711-2252	SX 150 13-25	1711-2252	Varg 23-25	1711-2252
EC 250F/300/350F 21-25	1711-2252	SX 250 89-25	1711-2252	YAMAHA	
EC 450F/500F 24-25	1711-2252	SX 300 23-25	1711-2252	YZ 125/250 17-25	1711-2251
EW 500F 24-25	1711-2252	SX-F 250 03-25	1711-2252	YZ 250F 16-25	1711-2251
HUSQVARNA		SX-F 350 11-25	1711-2252	YZ 450F 16-25	1711-2251
TC 125 16-25	1711-2252	SX-F 450 03-25	1711-2252	WR 250F 17-19	1711-2251
TC 250 14-25	1711-2252	EXC 125 99-17	1711-2252	WR 450F 16-18	1711-2251
FC 250/350/450 14-25	1711-2252	EXC 125 20-25	1711-2252		
TE 125 12-16	1711-2252	EXC 200 00-16	1711-2252		
TE 150 17-25	1711-2252	EXC 250 99-25	1711-2252		
TE 250 18-25	1711-2252	EXC 300 94-25	1711-2252		



See chart for details



SUPERMOTO ROTORS AND ADAPTERS

SUPERMOTO STREET ROTORS

- The ideal solution for the rider who wants race-oriented performance without the cost of switching to a full Supermoto Racing setup
- Designed for use with stock brake calipers, Supermoto Street Discs are 4 mm thick and utilize a 320 mm floating design
- Like the flame design outer ring, the inner carrier is in premium quality stainless steel, mounted with 10 stainless steel floaters
- Discs must be used with Moto-Master matching CNC-machined black adapter bracket

- For optimal performance it is recommended to use Moto-Master matching brake pads in the racing compound with this brake setup
- ABE approved, unless noted
- See page 884-890 of the 2024 Parts Europe Offroad catalog for the complete line of Moto-Master supermoto racing kits

SUPERMOTO RACING KITS

- Race-ready setup in one complete kit that includes all of the following:
- 12 mm radial master cylinder
- Stainless braided brake line
- Two-piece, 320 mm floating Flame racing disc
- 4-piston CNC-machined racing caliper and adapter bracket
- Mounting hardware
- Racing compound front brake pads
- Not ABE approved
- See page 884-890 of the 2024 Parts Europe Offroad catalog for the complete line of Moto-Master supermoto racing kits

ADAPTER BRACKETS FOR SUPERMOTARD STREET AND SUPERMOTARD RACING ROTORS

- Adapter bracket is needed to mount Supermotard Street and Supermotard Racing Discs
- Fully CNC-machined 6082 billet aluminum construction
- Supermotard street adapter brackets are used to relocate the stock brake caliper; Supermotard racing adapter brackets are for use with Moto-Master Supermotard 4-piston front caliper (PART# 1701-0592, sold separately)
- 320 mm adapter brackets are ABE, unless noted

320 MM RACING

FITS MODEL	RACING KIT (FOR BIKES W/ HEADLIGHTS)
GASGAS	
MC 125 21-25	1704-0609
MC 250/450F 21-25	1704-0609
EC 250/300 21-25	1704-0609
EC 250/350F 21-25	1704-0609
HUSABERG	
TE 125 12-14	1704-0609
TE 250/300 10-14	1704-0609
FE 390 09-12	1704-0609
FE 450 09-14	1704-0609
FE 570 08-12	1704-0609
HUSQVARNA	
TC 125 (Brembo caliper) 14-25	1704-0609
TC 125 (Magura caliper) 18	1704-0609
TC 250 (Brembo caliper) 14-25	1704-0609
TC 250 (Magura caliper) 18	1704-0609
FC 250 (Brembo caliper) 14-25	1704-0609
FC 250 (Magura caliper) 18	1704-0609
FC 350 (Brembo caliper) 14-25	1704-0609
FC 350 (Magura caliper) 18	1704-0609
FC 450 (Brembo caliper) 14-25	1704-0609
FC 450 (Magura caliper) 18	1704-0609
TE 125 12-16	1704-0609
TE 150 (Magura and Braktec calipers) 20-25	1704-0609
TE 150 (Brembo caliper) 17	1704-0609
TE 150 (Magura caliper) 18-19	1704-0609

FITS MODEL	RACING KIT (FOR BIKES W/ HEADLIGHTS)
HUSQVARNA (CONT)	
TE 250 (Brembo caliper) 14-17	1704-0609
TE 250 2T (Magura caliper) 18	1704-0609
TE 250 (Magura and Braktec calipers) 18-25	1704-0609
TE 300 (Brembo caliper) 14-17	1704-0609
TE 300 (Magura and Braktec calipers) 18-25	1704-0609
TE 300 (Magura caliper) 18	1704-0609
FE 250 (Brembo caliper) 14-17	1704-0609
FE 250 (Magura and Braktec calipers) 18-25	1704-0609
FE 350 (Brembo caliper) 14-17	1704-0609
FE 350 (Magura and Braktec calipers) 18-25	1704-0609
FE 450 (Brembo caliper) 14-17	1704-0609
FE 450 (Magura and Braktec calipers) 18-25	1704-0609
FE 501 (Brembo caliper) 14-17	1704-0609
FE 501 (Magura and Braktec calipers) 18-25	1704-0609
KTM	
SX 125/250 00-25	1704-0609
SX 150 07-25	1704-0609
SX 200 03	1704-0609
SX 400 00-10	1704-0609
SX 505 07-08	1704-0609
SX-F 250 06-25	1704-0609

FITS MODEL	RACING KIT (FOR BIKES W/ HEADLIGHTS)
KTM (CONT)	
SX-F 350 10-25	1704-0609
SX-F 450 03-25	1704-0609
SX-F 520 00-02	1704-0609
SX-F 525 03-07	1704-0609
EXC 125 04-17	1704-0609
EXC 150 20-25	1704-0609
EXC 200 00-16	1704-0609
EXC 250 18-25	1704-0609
EXC 300 00-25	1704-0609
EXC 400 00-11	1704-0609
EXC 450 02-15	1704-0609
EXC 500 12-16	1704-0609
EXC-F 350 12-25	1704-0609
EXC-F 450 16-25	1704-0609
EXC-F 500 17-25	1704-0609
EXC-F 520 00-02	1704-0609
EXC-F 525 03-07	1704-0609
EXC-F 530 08-12	1704-0609
SC 525 03-07	1704-0609
LC4 SC 625 01-04	1704-0609
LC4 SX 625 03-07	1704-0609

SUPERMOTO ROTORS AND ADAPTERS continued on next page.

EXHAUST

LUGGAGE

BIKE STANDS & ACCESSORIES

HANDLEBARS & HAND CONTROLS

FOOTPEGS & FOOT CONTROLS

BODY

GRAPHICS & SEATS

SPROCKETS

CHAINS

BRAKES

WHEELS & ACCESSORIES

SUSPENSION

ELECTRICAL & GAUGES

LIGHTING

ENGINE

FUEL/AIR SYSTEMS

HARDWARE & MERCHANDISING



See chart for details

SUPERMOTO ROTORS AND ADAPTERS (CONT)

320 MM STREET

	FITS MODEL	STREET FLAME DISC	STREET ADAPTER BRACKET	FITS MODEL	STREET FLAME DISC	STREET ADAPTER BRACKET	FITS MODEL	STREET FLAME DISC	STREET ADAPTER BRACKET
EXHAUST	BETA			HUSQVARNA (CONT)			KTM (CONT)		
	RR 250/300/350/290/400/430/480/498 13-18	1710-3560	1704-0493	TE 250 (Brembo caliper) 14-17	1710-1190	-	SX 400 00-10	1710-1190	-
LUGGAGE	Xtrainer 250/300 15-25	1710-3560	1704-0493	TE 250 (Magura caliper) 18-21	1710-1190	-	SX 505 07-08	1710-1190	-
	FANTIC			TE 250 (Braktec caliper) 22-24	1710-1190	-	SX-F 250 06-24	1710-1190	-
BIKE STANDS & ACCESSORIES	XX/XE 125 21-24	1710-1191	-	TE 300 (Brembo caliper) 14-17	1710-1190	-	SX-F 350 10-24	1710-1190	-
	XX 250 22-24	1710-1191	-	TE 300 (Magura caliper) 18-21	1710-1190	-	SX-F 450 03-24	1710-1190	-
HANDLEBARS & HAND CONTROLS	XXF 250/450 22-24	1710-1191	-	TE 300 (Braktec caliper) 22-24	1710-1190	-	SX-F 520 00-02	1710-1190	-
	XE 300 24	1711-1702	-	TE 300 (Magura caliper) 18-21	1710-1190	-	SX-F 525 03-07	1710-1190	-
FOOTPEGS & FOOT CONTROLS	XEF 250 21-24	1711-1702	-	TE 300 (Braktec caliper) 22-24	1710-1190	-	EXC 125 99-17	1710-1190	-
	XEF 310 24	1711-1702	-	TE 310 09-13	1710-1192	-	EXC 150 20-24	1710-1190	-
BODY	XEF 450 22-24	1711-1702	-	TE 400 01-02	1710-1192	-	EXC 200 98-16	1710-1190	-
	GASGAS			TE 410 00	1710-1192	-	EXC 250 99-18	1710-1190	-
GRAPHICS & SEATS	MC 125 21-24	1710-1190	-	TE 449 11-13	1710-1192	-	EXC 300 94-19	1710-1190	-
	MC 200 00-13	1710-3561	-	TE 450 03-10	1710-1192	-	EXC 300 Six Days 19-24	1710-1190	-
SPROCKETS	MC 250 00-12	1710-3561	-	TE 510 04-10	1710-1192	-	EXC 300 Erzbergrodeo 20-24	1710-1190	-
	MC 300 00-13	1710-3561	-	TE 511 11-13	1710-1192	-	EXC 400 00-11	1710-1190	-
CHAINS	MC 250F 10-14	1710-3561	-	TE 610 00-10	1710-1192	-	EXC 450 02-15	1710-1190	-
	MC 250F 21-24	1710-1190	-	TE 630 10-13	1710-1192	-	EXC 500 12-16	1710-1190	-
BRAKES	MC 350F 23-24	1710-1190	-	FE 250 (Brembo caliper) 14-17	1710-1190	-	EXC-F 250 99-24	1710-1190	-
	MC 400F 02-03	1710-3561	-	FE 250 (Magura caliper) 18-21	1710-1190	-	EXC-F 350 10-24	1710-1190	-
WHEELS & ACCESSORIES	MC 450F 03-14	1710-3561	-	FE 250 (Braktec caliper) 22-24	1710-1190	-	EXC-F 450 16-24	1710-1190	-
	MC 450F 21-24	1710-1190	-	FE 350 (Brembo caliper) 14-17	1710-1190	-	EXC-F 500 17-24	1710-1190	-
SUSPENSION	MC 515F 08-10	1710-3561	-	FE 350 (Magura caliper) 18-21	1710-1190	-	EXC-F 520 00-02	1710-1190	-
	EC 125 99-15	1710-3561	-	FE 350 (Braktec caliper) 22-24	1710-1190	-	EXC-F 525 03-07	1710-1190	-
ELECTRICAL & GAUGES	EC 200/250/300 00-20	1710-3561	-	FE 450 (Brembo caliper) 14-17	1710-1190	-	EXC-F 530 08-12	1710-1190	-
	EC 250/250F/300/350F 21-24	1710-1190	-	FE 450 (Magura caliper) 18-21	1710-1190	-	RIEJU		
FUEL/AIR SYSTEMS	EC 250F 10-15	1710-3561	-	FE 450 (Braktec caliper) 22-24	1710-1190	-	MR Racing 200 23-24	1710-3561	-
	EC 300F 13-15	1710-3561	-	FE 501 (Brembo caliper) 14-17	1710-1190	-	MR Ranger 200 22-24	1710-3561	-
HARDWARE & MERCHANDISING	EC 400F 02-03	1710-3561	-	FE 501 (Magura caliper) 18-21	1710-1190	-	MR Pro/Racing/Ranger 250/300 21-24	1710-3561	-
	EC 450F 03-15	1710-3561	-	FE 501 (Braktec caliper) 22-24	1710-1190	-	MR Ranger/Six Days 300 22-24	1710-3561	-
	EC 515F 08-10	1710-3561	-	CR/WR 125 00-13	1710-1192	-	SUZUKI		
	HONDA			WR 250 00-13	1710-1192	-	RM 125/250 89-10	1710-1191	-
	CRF 250R 19-25	-	1710-3691	WR 300 09-13	1710-1192	-	RM-Z 250 07-24	1710-1899	-
	CRF 450R 19-25	-	1710-3691	WR 360 00-02	1710-1192	-	RM-Z 450 05-24	1710-1899	-
	HUSABERG			WRE 125 00-13	1710-1192	-	DR-Z 250 01-07	1710-1191	-
	TE 125 12-14	1710-1190	-	SMS 125 01-13	1710-1192	-	DR-Z 400 00-09	1710-1191	-
	TE 250/300 10-14	1710-1190	-	TXC 250 09-13	1710-1192	-	SWM		
	FE 250/350/501 12-14	1710-1190	-	TXC 449 11-13	1710-1192	-	RS 125R 16	1710-1192	-
	FE 390 09-12	1710-1190	-	TXC 450 05-10	1710-1192	-	RS 300R 15-24	1710-1192	-
	FE 450 09-14	1710-1190	-	TXC 510 04-10	1710-1192	-	RS 500R 15-24	1710-1192	-
	FE 570 08-12	1710-1190	-	TXC 511 11-13	1710-1192	-	RS 650R 15-16	1710-1192	-
	HUSQVARNA			KAWASAKI			YAMAHA		
	TC 125 (Brembo caliper) 14-24	1710-1190	-	KX 125 06-08	1710-1900	-	YZ 125/250 92-24	1710-1191	-
	TC 250 (Brembo caliper) 03-13	1710-1192	-	KX 250 06-08	1710-1900	-	YZ 250F 01-24	1710-1191	-
	TC 250 (Brembo caliper) 14-24	1710-1190	-	KX 250F 06-18	1710-1900	-	YZ 400F 98-99	1710-1191	-
	TC 449 11-13	1710-1192	-	KX 250 19-24	1710-1900	-	YZ 450F 03-24	1710-1191	-
	TC 450 03-10	1710-1192	-	KX 450F 06-18	1710-1900	-	WR 125/250 93-07	1710-1191	-
	TC 510 04-10	1710-1192	-	KX 450 19-24	1710-1900	-	WR 200 98-00	1710-1191	-
	TC 570 01-04	1710-1192	-	KLX 400R/SR 03-06	1710-1191	-	WR 250 92-07	1710-1191	-
	TC 610 00-10	1710-1192	-	KLX 450 R 07-24	1710-1900	-	WR 250F 01-19	1710-1191	-
	FC 350 (Brembo caliper) 14-24	1710-1190	-	KTM			WR 250F 20-25	1711-1702	-
	FC 350 (Magura caliper) 18	1710-1190	-	SX 125 91-24	1710-1190	-	WR 400F 98-00	1710-1191	-
	FC 450 (Brembo caliper) 14-24	1710-1190	-	SX 150 09-24	1710-1190	-	WR 426F 01-02	1710-1191	-
	FC 450 (Magura caliper) 18	1710-1190	-	SX 200 03	1710-1190	-	WR 450F 03-18	1710-1191	-
	TE 125 12-17	1710-1190	-	SX 250 09-24	1710-1190	-	WR 450F 19-24	1711-1702	-
	TE 150 (Brembo caliper) 17	1710-1190	-	SX 250 95-96	1710-1190	-	TT 600R 93-04	1710-1191	-
	TE 150 (Magura caliper) 18-21	1710-1190	-	SX 360 98-02	1710-1190	-			

EXHAUST

LUGGAGE

BIKE STANDS & ACCESSORIES

HANDLEBARS & HAND CONTROLS

FOOTPEGS & FOOT CONTROLS

BODY

GRAPHICS & SEATS

SPROCKETS

CHAINS

BRAKES

WHEELS & ACCESSORIES

SUSPENSION

ELECTRICAL & GAUGES

LIGHTING

ENGINE

FUEL/AIR SYSTEMS

HARDWARE & MERCHANDISING



See chart for details

FLOATING FLAME FRONT BRAKE DISC

- Unique Flame design offers optimal cooling and unsurpassed smooth braking action
- For best performance we recommend using Moto-Master brake pads.
- Instant bolt-on performance upgrade for your bike

RALLY/DAKAR 298 MM

FITS MODEL	PART #	FITS MODEL	PART #
HONDA		HONDA (CONT)	
CRF 250M 14-19	1711-2321	CRF 250L/300L Rally 17-24	1711-2321

1711-2321

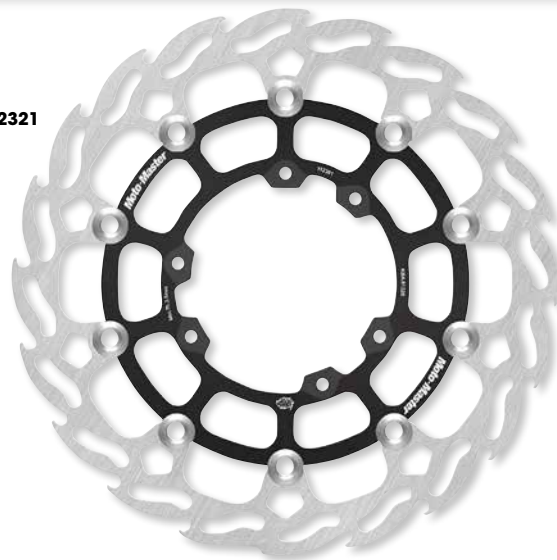

Fixed, grooved Wave



Fixed, standard Wave



Floating Grooved



WAVE® ROTORS

- Made of Galfer's unique laser-cut high carbon 420 stainless steel/8 composite
- Laser-cut and double-disc parallel ground to assure perfect flatness and excellent feel
- Rotors cool as they rotate to lower brake operating temperatures

- Do not require any extra parts for install
- Manufactured in Spain
- See pages 895-908 of the 2024 Parts Europe Offroad catalog for the complete line of Galfer Wave® rotors

WAVE® ROTORS continued on next page.



WAVE® ROTORS (CONT)

	FITS MODEL	TYPE	FRONT ROTOR PART #	TYPE	REAR ROTOR PART #	FITS MODEL	TYPE	FRONT ROTOR PART #	TYPE	REAR ROTOR PART #
EXHAUST	GASGAS					HUSQVARNA (CONT)				
	MC 85 21-25	Fixed, grooved	1711-2249	Fixed	1710-4118	FC 450 14-25	Floating	1711-2242	Fixed	1710-4118
LUGGAGE			-	Fixed, grooved	1711-2246	Floating, grooved	1711-2243	Fixed, grooved	1711-2246	
	MC 125 09-20	Floating, grooved	1711-2248	-	-	Fixed	1711-2245	-	-	
BIKE STANDS & ACCESSORIES	MC 125 21-25	Floating	1711-2242	Fixed	1710-4118	Fixed, grooved	1711-2244	-	-	
		Floating, grooved	1711-2243	Fixed, grooved	1711-2246	TE 125 14-25	Floating	1711-2242	Fixed	1710-4118
		Fixed	1711-2245	-	-	Floating, grooved	1711-2243	Fixed, grooved	1711-2246	
		Fixed, grooved	1711-2244	-	-	Fixed	1711-2245	-	-	
HANDLEBARS & HAND CONTROLS	MC 250 10-15	Floating, grooved	1711-2248	-	-	Fixed, grooved	1711-2244	-	-	
	MC 250/F 21-25	Floating	1711-2242	Fixed	1710-4118	TE 150 22-25	Floating	1711-2242	Fixed	1710-4118
		Floating, grooved	1711-2243	Fixed, grooved	1711-2246	Floating, grooved	1711-2243	Fixed, grooved	1711-2246	
		Fixed	1711-2245	-	-	Fixed	1711-2245	-	-	
FOOTPEGS & FOOT CONTROLS		Fixed, grooved	1711-2244	-	-	Fixed, grooved	1711-2244	-	-	
	MC 350F 21-25	Floating	1711-2242	Fixed	1710-4118	TE 250 14-25	Floating	1711-2242	Fixed	1710-4118
		Floating, grooved	1711-2243	Fixed, grooved	1711-2246	Floating, grooved	1711-2243	Fixed, grooved	1711-2246	
		Fixed	1711-2245	-	-	Fixed	1711-2245	-	-	
BODY		Fixed, grooved	1711-2244	-	-	Fixed, grooved	1711-2244	-	-	
	MC 450F 21-25	Floating	1711-2242	Fixed	1710-4118	TE 300 14-25	Floating	1711-2242	Fixed	1710-4118
		Floating, grooved	1711-2243	Fixed, grooved	1711-2246	Floating, grooved	1711-2243	Fixed, grooved	1711-2246	
		Fixed	1711-2245	-	-	Fixed	1711-2245	-	-	
GRAPHICS & SEATS		Fixed, grooved	1711-2244	-	-	Fixed, grooved	1711-2244	-	-	
	EC 125 16-20	Floating	1711-2248	-	-	FE 250 14-25	Floating	1711-2242	Fixed	1710-4118
	EC 250 09-20	Floating, grooved	1711-2248	-	-	Floating, grooved	1711-2243	Fixed, grooved	1711-2246	
	EC 250/F 21-25	Floating	1711-2242	Fixed	1710-4118	Fixed	1711-2245	-	-	
SPROCKETS		Floating, grooved	1711-2243	Fixed, grooved	1711-2246	Fixed, grooved	1711-2244	-	-	
		Fixed	1711-2245	-	-	FE 350 14-25	Floating	1711-2242	Fixed	1710-4118
		Fixed, grooved	1711-2244	-	-	Floating, grooved	1711-2243	Fixed, grooved	1711-2246	
		Fixed, grooved	1711-2244	-	-	Fixed	1711-2245	-	-	
CHAINS	EC 300 08-20	Floating, grooved	1711-2248	-	-	Fixed, grooved	1711-2244	-	-	
	EC 300 21-25	Floating	1711-2242	Fixed	1710-4118	FE 450 14-25	Floating	1711-2242	Fixed	1710-4118
		Floating, grooved	1711-2243	Fixed, grooved	1711-2246	Floating, grooved	1711-2243	Fixed, grooved	1711-2246	
		Fixed	1711-2245	-	-	Fixed	1711-2245	-	-	
BRAKES		Fixed, grooved	1711-2244	-	-	Fixed, grooved	1711-2244	-	-	
	EC 350F 21-25	Floating	1711-2242	Fixed	1710-4118	FE 501 14-25	Floating	1711-2242	Fixed	1710-4118
		Floating, grooved	1711-2243	Fixed, grooved	1711-2246	Floating, grooved	1711-2243	Fixed, grooved	1711-2246	
		Fixed	1711-2245	-	-	Fixed	1711-2245	-	-	
WHEELS & ACCESSORIES		Fixed, grooved	1711-2244	-	-	Fixed, grooved	1711-2244	-	-	
	EC 450F 12-14	Floating, grooved	1711-2248	-	-	KAWASAKI				
						KX 125 03-05	Floating	1711-1649	-	-
						KX 125 06	Fixed, grooved	1711-2269	-	-
SUSPENSION	HONDA					KX 250 03-05	Floating	1711-1649	-	-
	CR 125R 95-07	Floating	1711-2228	Floating	1711-1630	KX 250 06-14	Fixed, grooved	1711-2269	-	-
		Floating, grooved	1711-2229	-	-	KX 450 06-14	Fixed, grooved	1711-2269	-	-
		Fixed, grooved	1711-2230	-	-	KXE 450 06	Fixed, grooved	1711-2269	-	-
ELECTRICAL & GAUGES		Fixed	1711-2231	-	-	KLX 450R 07	Fixed, grooved	1711-2269	-	-
	CR 250R 95-07	Floating	1711-2228	Floating	1711-1630	KTM				
		Floating, grooved	1711-2229	-	-	SX 85 03-25	Fixed, grooved	1711-2249	-	-
		Fixed, grooved	1711-2230	-	-	SX 105 07-11	Fixed, grooved	1711-2249	-	-
LIGHTING		Fixed	1711-2231	-	-	SX 125 93-14	Floating	1711-2242	Fixed	1710-4118
	CRF 250R/X/RX 04-25	Floating	1711-2228	Floating	1711-1630	Floating, grooved	1711-2243	Fixed, grooved	1711-2246	
		Floating, grooved	1711-2229	-	-	Fixed	1711-2245	-	-	
		Fixed, grooved	1711-2230	-	-	Fixed, grooved	1711-2244	-	-	
ENGINE		Fixed	1711-2231	-	-	SX 144 08	Floating	1711-2242	Fixed	1710-4118
	CRF 450R/X/RX 01-25	Floating	1711-2228	Floating	1711-1630	Floating, grooved	1711-2243	Fixed, grooved	1711-2246	
		Floating, grooved	1711-2229	-	-	Fixed	1711-2245	-	-	
		Fixed, grooved	1711-2230	-	-	Fixed, grooved	1711-2244	-	-	
FUEL/AIR SYSTEMS		Fixed	1711-2231	-	-	SX 150 19-25	Floating	1711-2242	Fixed	1710-4118
	HUSQVARNA					Floating, grooved	1711-2243	Fixed, grooved	1711-2246	
	TC 85 14-25	Fixed, grooved	1711-2249	-	-	Fixed	1711-2245	-	-	
	TC 125 14-25	Floating	1711-2242	Fixed	1710-4118	Fixed, grooved	1711-2244	-	-	
HARDWARE & MERCHANDISING		Floating, grooved	1711-2243	Fixed, grooved	1711-2246	SX 200 03-04	Floating	1711-2242	Fixed	1710-4118
		Fixed	1711-2245	-	-	Floating, grooved	1711-2243	Fixed, grooved	1711-2246	
		Fixed, grooved	1711-2244	-	-	Fixed	1711-2245	-	-	
	TC 250 14-25	Floating	1711-2242	Fixed	1710-4118	Fixed, grooved	1711-2244	-	-	
ENGINE		Floating, grooved	1711-2243	Fixed, grooved	1711-2246	SX 250 03-25	Floating	1711-2242	Fixed	1710-4118
		Fixed	1711-2245	-	-	Floating, grooved	1711-2243	Fixed, grooved	1711-2246	
		Fixed, grooved	1711-2244	-	-	Fixed	1711-2245	-	-	
	FC 250 14-25	Floating	1711-2242	Fixed	1710-4118	Fixed, grooved	1711-2244	-	-	
FUEL/AIR SYSTEMS		Floating, grooved	1711-2243	Fixed, grooved	1711-2246	SX 300 23-25	Floating	1711-2242	Fixed	1710-4118
		Fixed	1711-2245	-	-	Floating, grooved	1711-2243	Fixed, grooved	1711-2246	
		Fixed, grooved	1711-2244	-	-	Fixed	1711-2245	-	-	
	FC 350 14-25	Floating	1711-2242	Fixed	1710-4118	Fixed, grooved	1711-2244	-	-	
ENGINE		Floating, grooved	1711-2243	Fixed, grooved	1711-2246					
		Fixed	1711-2245	-	-					
		Fixed, grooved	1711-2244	-	-					
	FC 350 14-25	Floating	1711-2242	Fixed	1710-4118					



WAVE® ROTORS (CONT)

FITS MODEL	TYPE	FRONT ROTOR PART #	TYPE	REAR ROTOR PART #
KTM (CONT)				
SX 440 94-25	Floating	1711-2242	Fixed	1711-2246
	Floating, grooved	1711-2243	Fixed, grooved	1711-2246
	Fixed	1711-2245	-	-
	Fixed, grooved	1711-2244	-	-
SX 450 03-06	Floating	1711-2242	Fixed	1710-4118
	Floating, grooved	1711-2243	Fixed, grooved	1711-2246
	Fixed	1711-2245	-	-
	Fixed, grooved	1711-2244	-	-
SX 500 93-25	Floating	1711-2242	Fixed	1710-4118
	Floating, grooved	1711-2243	Fixed, grooved	1711-2246
	Fixed	1711-2245	-	-
	Fixed, grooved	1711-2244	-	-
SX 505 07-25	Floating	1711-2242	Fixed	1710-4118
	Floating, grooved	1711-2243	Fixed, grooved	1711-2246
	Fixed	1711-2245	-	-
	Fixed, grooved	1711-2244	-	-
SX 525 03-25	Floating	1711-2242	Fixed	1710-4118
	Floating, grooved	1711-2243	Fixed, grooved	1711-2246
	Fixed	1711-2245	-	-
	Fixed, grooved	1711-2244	-	-
SX 620 94	Floating	1710-3135	-	-
	Floating, grooved	1711-2243	Fixed, grooved	1711-2246
SX-F 250 15-25	Floating	1711-2242	Fixed	1710-4118
	Floating, grooved	1711-2243	Fixed, grooved	1711-2246
	Fixed	1711-2245	-	-
	Fixed, grooved	1711-2244	-	-
SX-F 350 11-25	Floating	1711-2242	Fixed	1710-4118
	Floating, grooved	1711-2243	Fixed, grooved	1711-2246
	Fixed	1711-2245	-	-
	Fixed, grooved	1711-2244	-	-
SX-F 450 07-25	Floating	1711-2242	Fixed	1710-4118
	Floating, grooved	1711-2243	Fixed, grooved	1711-2246
	Fixed	1711-2245	-	-
	Fixed, grooved	1711-2244	-	-
EGS 200 99-02	Floating	1711-2242	Fixed	1710-4118
	Floating, grooved	1711-2243	Fixed, grooved	1711-2246
	Fixed	1711-2245	-	-
	Fixed, grooved	1711-2244	-	-
EGS 250 99-25	Floating	1711-2242	Fixed	1710-4118
	Floating, grooved	1711-2243	Fixed, grooved	1711-2246
	Fixed	1711-2245	-	-
	Fixed, grooved	1711-2244	-	-
EGS 300 93-03	Floating	1711-2242	Fixed	1710-4118
	Floating, grooved	1711-2243	Fixed, grooved	1711-2246
	Fixed	1711-2245	-	-
	Fixed, grooved	1711-2244	-	-
EGS 400 LC4 94-95	Floating	1711-2242	Fixed	1710-4118
	Floating, grooved	1711-2243	Fixed, grooved	1711-2246
	Fixed	1711-2245	-	-
	Fixed, grooved	1711-2244	-	-
EXC 125 04-25	Floating	1711-2242	Fixed	1710-4118
	Floating, grooved	1711-2243	Fixed, grooved	1711-2246
	Fixed	1711-2245	-	-
	Fixed, grooved	1711-2244	-	-
EXC 200 98-25	Floating	1711-2242	Fixed	1710-4118
	Floating, grooved	1711-2243	Fixed, grooved	1711-2246
	Fixed	1711-2245	-	-
	Fixed, grooved	1711-2244	-	-
EXC 250 04-25	Floating	1711-2242	Fixed	1710-4118
	Floating, grooved	1711-2243	Fixed, grooved	1711-2246
	Fixed	1711-2245	-	-
	Fixed, grooved	1711-2244	-	-
EXC 300 04-25	Floating	1711-2242	Fixed	1710-4118
	Floating, grooved	1711-2243	Fixed, grooved	1711-2246
	Fixed	1711-2245	-	-
	Fixed, grooved	1711-2244	-	-
EXC 400 04-25	Floating	1711-2242	Fixed	1710-4118
	Floating, grooved	1711-2243	Fixed, grooved	1711-2246
	Fixed	1711-2245	-	-
	Fixed, grooved	1711-2244	-	-

FITS MODEL	TYPE	FRONT ROTOR PART #	TYPE	REAR ROTOR PART #
KTM (CONT)				
EXC 450 04-25	Floating	1711-2242	Fixed	1710-4118
	Floating, grooved	1711-2243	Fixed, grooved	1711-2246
	Fixed	1711-2245	-	-
	Fixed, grooved	1711-2244	-	-
EXC 500 14-25	Floating	1711-2242	Fixed	1710-4118
	Floating, grooved	1711-2243	Fixed, grooved	1711-2246
	Fixed	1711-2245	-	-
	Fixed, grooved	1711-2244	-	-
EXC 525 04-25	Floating	1711-2242	Fixed	1710-4118
	Floating, grooved	1711-2243	Fixed, grooved	1711-2246
	Fixed	1711-2245	-	-
	Fixed, grooved	1711-2244	-	-
EXC 620 94	Floating	1710-3135	-	-
	Floating, grooved	1711-2243	Fixed, grooved	1711-2246
EXC 625 03-25	Floating	1711-2242	Fixed	1710-4118
	Floating, grooved	1711-2243	Fixed, grooved	1711-2246
	Fixed	1711-2245	-	-
	Fixed, grooved	1711-2244	-	-
EXC-F 250 15-25	Floating	1711-2242	Fixed	1710-4118
	Floating, grooved	1711-2243	Fixed, grooved	1711-2246
	Fixed	1711-2245	-	-
	Fixed, grooved	1711-2244	-	-
EXC-F 350 12-25	Floating	1711-2242	Fixed	1710-4118
	Floating, grooved	1711-2243	Fixed, grooved	1711-2246
	Fixed	1711-2245	-	-
	Fixed, grooved	1711-2244	-	-
EXC-F 450 17-25	Floating	1711-2242	Fixed	1710-4118
	Floating, grooved	1711-2243	Fixed, grooved	1711-2246
	Fixed	1711-2245	-	-
	Fixed, grooved	1711-2244	-	-
EXC-F 500 17-25	Floating	1711-2242	Fixed	1710-4118
	Floating, grooved	1711-2243	Fixed, grooved	1711-2246
	Fixed	1711-2245	-	-
	Fixed, grooved	1711-2244	-	-
SUZUKI				
RM 85 05-25	Fixed, grooved	1711-2239	-	-
	Fixed	1711-2240	-	-
RM-Z 250 04-06	Floating	1711-1649	-	-
YAMAHA				
YZ 80/85 93-25	Fixed, grooved	1711-2239	-	-
	Fixed	1711-2240	-	-
YZ 125 22-25	Floating	1711-2232	Fixed	1711-2241
	Floating, grooved	1711-2233	-	-
	Fixed, grooved	1711-2234	-	-
	Fixed	1711-2235	-	-
YZ 250/F 22-25	Floating	1711-2232	Fixed	1711-2241
	Floating, grooved	1711-2233	-	-
	Fixed, grooved	1711-2234	-	-
	Fixed	1711-2235	-	-
YZ 450F 20-25	Floating	1711-2232	Fixed	1711-2241
	Floating, grooved	1711-2233	-	-
	Fixed, grooved	1711-2234	-	-
	Fixed	1711-2235	-	-
WR 250F 17-25	Floating	1711-2232	-	-
	Floating, grooved	1711-2233	-	-
	Fixed, grooved	1711-2234	-	-
	Fixed	1711-2235	-	-
WR 450F 20-25	Floating	1711-2232	-	-
	Floating, grooved	1711-2233	-	-
	Fixed, grooved	1711-2234	-	-
	Fixed	1711-2235	-	-

EXHAUST

LUGGAGE

BIKE STANDS & ACCESSORIES

HANDLEBARS & HAND CONTROLS

FOOTPEGS & FOOT CONTROLS

BODY

GRAPHICS & SEATS

SPROCKETS

CHAINS

BRAKES

WHEELS & ACCESSORIES

SUSPENSION

ELECTRICAL & GAUGES

LIGHTING

ENGINE

FUEL/AIR SYSTEMS

HARDWARE & MERCHANDISING



1710-4640



SHARK BRAKE ROTORS

- Reduces unsprung weight
- Increases braking power
- Improves heat dissipation
- Excellent resistance to corrosion
- Less tendency to warp
- 3 mm front thickness
- 4 mm or 5 mm rear thickness

FITS MODEL	FRONT PART #	REAR PART #
BETA		
RR/RX 250/300/350/400/430/450/480/498 12-25	1711-2309	1710-4641
	-	1711-2310 ¹
GASGAS		
MC 85 21-23	-	1710-4640
	-	1711-2308 ¹
MC 125 21-25	1711-2307	1710-4640
	-	1711-2308 ¹
MC 250/F 21-25	1711-2307	1710-4640
	-	1711-2308 ¹
MC 350F 21-25	1711-2307	1710-4640
	-	1711-2308 ¹
MC 450F 21-25	1711-2307	1710-4640
	-	1711-2308 ¹
EC 250/F 21-25	1711-2307	1710-4640
	-	1711-2308 ¹
EC 300/F 21-25	1711-2307	1710-4640
	-	1711-2308 ¹
EC 400FSE 01	-	1710-4640
	-	1711-2308 ¹
HONDA		
CR 125R 02-07	-	1710-4645
	-	1711-2301 ¹
CR 250R 02-07	-	1710-4645
	-	1711-2301 ¹
CRF 250R 04-14	-	1710-4645
	-	1711-2301 ¹
CRF 250R 15-25	1711-2302	1710-4645
	-	1711-2301 ¹
CRF 250X 04	-	1710-4645
	-	1711-2301 ¹
CRF 450F/R 04-14	-	1710-4645
	-	1711-2301 ¹
CRF 450RL/R/RX 15-25	1711-2302	1710-4645
	-	1711-2301 ¹
HUSQVARNA		
TC 85 21-25	-	1710-4640
	-	1711-2308 ¹
TC 125 14-25	1711-2307	1710-4640
	-	1711-2308 ¹
TC 250 14-25	1711-2307	1710-4640
	-	1711-2308 ¹
FC 250 14-25	1711-2307	1710-4640
	-	1711-2308 ¹

FITS MODEL	FRONT PART #	REAR PART #
HUSQVARNA (CONT)		
FC 350 14-25	1711-2307	1710-4640
	-	1711-2308 ¹
TE 125 14-25	1711-2307	1710-4640
	-	1711-2308 ¹
TE 150 22-25	1711-2307	1710-4640
	-	1711-2308 ¹
TE 250 14-25	1711-2307	1710-4640
	-	1711-2308 ¹
TE 300 14-25	1711-2307	1710-4640
	-	1711-2308 ¹
FE 250 14-25	1711-2307	1710-4640
	-	1711-2308 ¹
FE 350 14-25	1711-2307	1710-4640
	-	1711-2308 ¹
FE 450 14-25	1711-2307	1710-4640
	-	1711-2308 ¹
FE 501 14-25	1711-2307	1710-4640
	-	1711-2308 ¹
KAWASAKI		
KX 125 04-06	-	1711-2303 ¹
KX 250 03-08	-	1711-2303 ¹
KX 250F 04-25	-	1711-2303 ¹
KX 450F 06-25	-	1711-2303 ¹
KLX 450R 07	-	1711-2303 ¹
KTM		
SX 125 93-25	1711-2307	1710-4640
	-	1711-2308 ¹
SX 144 08	1711-2307	1710-4640
	-	1711-2308 ¹
SX 200 03-04	1711-2307	1710-4640
	-	1711-2308 ¹
SX 250 94-25	1711-2307	1710-4640
	-	1711-2308 ¹
SX 300 23	1711-2307	1710-4640
	-	1711-2308 ¹
SX 440 94	1711-2307	1710-4640
	-	1711-2308 ¹
SX 450 03	1711-2307	1710-4640
	-	1711-2308 ¹
SX 505 07	1711-2307	1710-4640
	-	1711-2308 ¹
SX 525 03-04	1711-2307	1710-4640
	-	1711-2308 ¹

FITS MODEL	FRONT PART #	REAR PART #
KTM (CONT)		
SX-F 250 15-25	1711-2307	1710-4640
	-	1711-2308 ¹
SX-F 350 11-25	1711-2307	1710-4640
	-	1711-2308 ¹
SX-F 450 07-25	1711-2307	1710-4640
	-	1711-2308 ¹
EXC 150 21-25	1711-2307	1710-4640
	-	1711-2308 ¹
EXC 200 98-25	1711-2307	1710-4640
	-	1711-2308 ¹
EXC 300 03-25	1711-2307	1710-4640
	-	1711-2308 ¹
EXC 300 Six Days 19-25	1711-2307	1710-4640
	-	1711-2308 ¹
EXC 400 04-25	1711-2307	1710-4640
	-	1711-2308 ¹
EXC 450 03-25	1711-2307	1710-4640
	-	1711-2308 ¹
EXC 500 14-25	1711-2307	1710-4640
	-	1711-2308 ¹
EXC 525 03-25	1711-2307	1710-4640
	-	1711-2308 ¹
EXC-F 250/Six Days 15-25	1711-2307	1710-4640
	-	1711-2308 ¹
EXC-F 350 12-25	1711-2307	1710-4640
	-	1711-2308 ¹
EXC-F 450/Six Days 17-25	1711-2307	1710-4640
	-	1711-2308 ¹
EXC-F 500/Six Days 17-25	1711-2307	1710-4640
	-	1711-2308 ¹
SHERCO		
SE/SEF 125/250/300/450 14-24	-	1710-4642
SE/SEF/SEF-R Factory/Fork 250/300/450 14-21	1711-2313	-
SUZUKI		
RM-Z 250 07-19	-	1711-2305 ¹
RM-Z 450 05-18	-	1711-2305 ¹
YAMAHA		
YZ 125F 22-23	1711-2304	1711-2306 ¹
YZ 250F 22-23	1711-2304	1711-2306 ¹
YZ 450F 20-23	1711-2304	1711-2306 ¹
WR 250F 17-23	1711-2304	-
WR 450F 20-23	1711-2304	-

¹ 4 mm thickness.



OVERSIZED BRAKE DISC KIT

- Bolt-on brake performance upgrade in a box
- Kit includes oversize front brake rotor
- Oversize front brake rotors are 270 mm (unless noted in chart)
- Kit also includes all necessary brake pads for complete replacement
- Include brake caliper relocation bracket
- See pages 898-900 of the 2024 Parts Europe Offroad catalog for the complete line of brake disc kits

FITS MODEL	FRONT ROTOR TYPE	FRONT KIT PART #
HONDA		
CRF 250/450R/L 19-22	Fixed, grooved (270 mm)	1704-0549



BRAKE CALIPER RELOCATION BRACKETS

- Brake Caliper Adapter for oversize Brake Discs
- Anodized Aluminium

FITS MODEL	SIZE	COLOR	PART #
GASGAS			
MC 125 21-23	270 mm	Orange	1704-0598
	280 mm	Black	1704-0604
MC 250/250F 21-23	270 mm	Orange	1704-0598
	280 mm	Black	1704-0604
MC 350F 22-23	270 mm	Orange	1704-0598
	280 mm	Black	1704-0604
MC 450F 22-23	270 mm	Orange	1704-0598
	280 mm	Black	1704-0604
EC 250/300 18-20	270 mm	Black	1704-0597
HONDA			
CRF 250R 15-17	270 mm	Black	1704-0599
CRF 250R/RX 19-24	270 mm	Black	1711-2275
	280 mm	Black	1704-0605
CRF 450R/RX 15-18	270 mm	Black	1704-0599
	270 mm	Black	1711-2275
CRF 450R/RX 19-24	280 mm	Black	1704-0605
HUSQVARNA			
TC 85 14-20	260 mm	Black	1704-0606
TC 125 14-24	270 mm	Orange	1704-0598
	280 mm	Black	1704-0604
	280 mm	Black	1704-0604
TC 250 14-24	270 mm	Orange	1704-0598
	280 mm	Black	1704-0604
FC 250 14-24	270 mm	Orange	1704-0598
	280 mm	Black	1704-0604
FC 350 14-24	270 mm	Orange	1704-0598
	280 mm	Black	1704-0604
FC 450 14-24	270 mm	Orange	1704-0598
	280 mm	Black	1704-0604
TE 125 14-16	270 mm	Orange	1704-0598
	280 mm	Black	1704-0604
TE 150 7-24	270 mm	Orange	1704-0598
	280 mm	Black	1704-0604
TE 250 4-22	270 mm	Orange	1704-0598
	280 mm	Black	1704-0604
TE 300 14-24	270 mm	Orange	1704-0598
	280 mm	Black	1704-0604
FE 250 14-22	270 mm	Orange	1704-0598
	280 mm	Black	1704-0604
FE 350 14-24	270 mm	Orange	1704-0598
	280 mm	Black	1704-0604

FITS MODEL	SIZE	COLOR	PART #
HUSQVARNA (CONT)			
FE 450 15-24	270 mm	Orange	1704-0598
	280 mm	Black	1704-0604
	280 mm	Black	1704-0604
FE 501 14-24	270 mm	Orange	1704-0598
	280 mm	Black	1704-0604
KAWASAKI			
KX 125 95-02	270 mm	Black	1704-0596
KX 250/F 94-14	270 mm	Black	1704-0596
KX 250/F/X 06-23	280 mm	Black	1704-0603
KX 450F 07-14	270 mm	Black	1704-0596
KX 450F 07-19	280 mm	Black	1704-0603
KX 500 95-04	270 mm	Black	1704-0596
KLX 450R 08-12	280 mm	Black	1704-0603
KTM			
SX 85 12-20	260 mm	Black	1704-0606
SX 125 09-24	270 mm	Black	1711-2274
	270 mm	Orange	1704-0598
	280 mm	Black	1704-0604
SX 250 09-24	270 mm	Black	1711-2274
	270 mm	Orange	1704-0598
	280 mm	Black	1704-0604
SX 300 09-24	270 mm	Black	1711-2274
	270 mm	Orange	1704-0598
	280 mm	Black	1704-0604
SX-F 250 09-24	270 mm	Black	1711-2274
	270 mm	Orange	1704-0598
	280 mm	Black	1704-0604
SX-F 350 11-24	270 mm	Black	1711-2274
	270 mm	Orange	1704-0598
	280 mm	Black	1704-0604
SX-F 450 09-24	270 mm	Black	1711-2274
	270 mm	Orange	1704-0598
	280 mm	Black	1704-0604
EXC 450 10-14	270 mm	Black	1711-2274
	270 mm	Orange	1704-0598
	280 mm	Black	1704-0604
EXC 500 10-16	270 mm	Black	1711-2274
	270 mm	Orange	1704-0598
	280 mm	Black	1704-0604
EXC 530 10-12	270 mm	Black	1711-2274
	270 mm	Orange	1704-0598
	280 mm	Black	1704-0604

BRAKE CALIPER RELOCATION BRACKETS continued on next page.

EXHAUST

LUGGAGE

BIKE STANDS & ACCESSORIES

HANDLEBARS & HAND CONTROLS

FOOTPEGS & FOOT CONTROLS

BODY

GRAPHICS & SEATS

SPROCKETS

CHAINS

BRAKES

WHEELS & ACCESSORIES

SUSPENSION

ELECTRICAL & GAUGES

LIGHTING

ENGINE

FUEL/AIR SYSTEMS

HARDWARE & MERCHANDISING



BRAKE CALIPER RELOCATION BRACKETS (CONT)

FITS MODEL	SIZE	COLOR	PART #
KTM (CONT)			
EXC-F 250 17-19	270 mm	Black	1711-2274
	270 mm	Orange	1704-0598
	280 mm	Black	1704-0604
EXC-F 350 12-24	270 mm	Black	1711-2274
	270 mm	Orange	1704-0598
	280 mm	Black	1704-0604
EXC-F 500 17-24	270 mm	Black	1711-2274
	270 mm	Orange	1704-0598
	280 mm	Black	1704-0604
SHERCO			
250 SE/SEF/SE-R WP	270 mm	Black	1704-0600
300 SE/SEF/SEF-R/SE-R WP	270 mm	Black	1704-0600
450 SEF/SEF-R WP	270 mm	Black	1704-0600
SUZUKI			
RM 125 96-08	270 mm	Black	1704-0596
	280 mm	Black	1704-0603

FITS MODEL	SIZE	COLOR	PART #
SUZUKI (CONT)			
RM 250 96-08	270 mm	Black	1704-0596
	280 mm	Black	1704-0603
	270 mm	Black	1704-0596
RM-Z 250 09-23	270 mm	Black	1704-0596
	280 mm	Black	1704-0603
RM-Z 450 09-23	270 mm	Black	1704-0596
	280 mm	Black	1704-0603
RMX 450 05-17	270 mm	Black	1704-0596
	280 mm	Black	1704-0603
DR-Z 400 00-20	270 mm	Black	1704-0596
	280 mm	Black	1704-0603
YAMAHA			
YZ 85 02-17	250 mm	Black	1704-0601
YZ 125 07-21	280 mm	Black	1704-0602
YZ 250/F/FX/X 07-23	280 mm	Black	1704-0602
YZ 450F/FX/X 08-23	280 mm	Black	1704-0602



BRAKE CALIPER ADAPTER

• Fully CNC-machined 6082 billet aluminum adapter brackets are used to relocate the stock brake caliper to accommodate oversize discs

• For rear 240 mm oversize Flame discs

NOTE: Use only in combination with 16" to 17" wheels.



FITS MODEL	PART #
GASGAS	
MC 125/250/250F/350F/450F 24-25	1701-0795
EC 250/250F/300/350F/450F/500F 24-25	1701-0795
HUSQVARNA	
TC 125/250 24-25	1701-0795

FITS MODEL	PART #
HUSQVARNA (CONT)	
FC 250/350/450 23-25	1701-0795
TE 150/250/300 24-25	1701-0795
FE 250/350/450/501 24-25	1701-0795

FITS MODEL	PART #
KTM	
SX 125/250/300 23-25	1701-0795
SX-F 250/350/450 23-25	1701-0795
EXC 150/250/300 24-25	1701-0795
EXC-F 250/350/450/500 24-25	1701-0795



BRAKE CALIPER REBUILD KITS

• Each kit includes all necessary rubber components and brake pins if it's applicable
• Applications cover most popular models

FITS MODEL	POSITION	PART #
BETA		
RX 300 21-23	Front	1702-0755
RR 2T 125/200 19-23	Front	1702-0755
RR 2T 250/300 13-23	Front	1702-0755
RR 2T Race 125/200 23	Front	1702-0755
RR 4T 350 11-23	Front	1702-0755
RR 4T 390 15-21	Front	1702-0755
RR 4T 400 10-14	Front	1702-0755
RR 4T 430 15-23	Front	1702-0755
RR 4T 450 10-14	Front	1702-0755
RR 4T 480 18-23	Front	1702-0755
RR 4T 498 12-14	Front	1702-0755
RR 4T 520 10-11	Front	1702-0755
RR Race 4T 350 17-23	Front	1702-0755
RR Race 4T 390 22-23	Front	1702-0755
RR Race 4T 430 22-23	Front	1702-0755
RR Race 4T 480 22-23	Front	1702-0755

FITS MODEL	POSITION	PART #
BETA (CONT)		
RS 4T 390 15-16	Front	1702-0755
RS 4T 400 14	Front	1702-0755
RS 4T 430 5-16	Front	1702-0755
RS 4T 480 15-16	Front	1702-0755
RS 4T 500 15-16	Front	1702-0755
RS 4T 520 14-15	Front	1702-0755
RR-S 4T 350 22-23	Front	1702-0755
RR-S 4T 430 17-23	Front	1702-0755
RR-S 4T 500 17-23	Front	1702-0755
Xtrainer 300 15-23	Front	1702-0755
GASGAS		
MC 85 17/14 22-24	Front	1702-0754
	Rear	1702-0756
MC 85 19/16 BW 22-24	Front	1702-0754
	Rear	1702-0756

FITS MODEL	POSITION	PART #
HUSQVARNA		
TC 65 23-24	Front	1702-0756
	Rear	1702-0756
TC 85 22-24	Front	1702-0754
	Rear	1702-0756
TC 85 BW 23-24	Front	1702-0754
	Rear	1702-0756
KTM		
SX 65 23-24	Front	1702-0756
	Rear	1702-0756
SX 85 21-24	Front	1702-0754
	Rear	1702-0756
SX 85 BW 22-24	Front	1702-0754
	Rear	1702-0756



BRAKE PAD PIN SETS

• Includes required quantities for front and rear brake pad hanger pin sets
• Made for OEM applications to fit GasGas, Husqvarna and KTM applications

FITS MODEL	PART #
GASGAS	
MC 65 21-23	1702-0752
MC 85 21-23	1702-0753

FITS MODEL	PART #
HUSQVARNA	
TC 65 23	1702-0752
TC 85 21-23	1702-0753

FITS MODEL	PART #
KTM	
SX 85 21-23	1702-0753
Freeride E-XC 23	1702-0753





PRO SHARK FIN DISC PROTECTORS WITH BRAKE CARRIER

FOR SHERCO 13-20 (ALL)

- The burliest rear disc guard on the market, offering protection for the caliper and the rotor
- This disc protector replaces the entire brake carrier for the most coverage available
- Replacement lower fin available, PART #M13-051, sold separately
- See page 948 of the 2024 Parts Europe Offroad catalogue for additional Moose Racing Pro Shark Fin disc protectors with brake carrier applications

DESCRIPTION	PART #
Pro Shark Fin disc protector with brake carrier	1711-1349



REAR ROTOR GUARDS

- Great way to personalize your bike or add extra protection for the rear rotor against rocks and debris
- Provides better protection versus the standard plastic OEM guards
- Mounts to existing mounting points on rear brake caliper bracket
- CNC machined from 6061-T6 aluminum
- Anodized colors that match the brand
- See page 947 of the 2024 Parts Europe Offroad catalog for the full line of Moose Racing Rear Rotor Guards

FITS MODEL	COLOR	PART #
GASGAS		
EC 250/250F/300 21-22	Red	1711-2267
HUSQVARNA		
FE 250/450/501, TE 250/300 22	Red	1711-2267



REAR DISC GUARD

- Ultimate protection for the rear brake disc
- Machined from a single piece of aluminum with a black anodized finish
- Also replaces the brake caliper support
- See page 950 of the 2024 Parts Europe Offroad catalog for the complete line of SCAR rear disc guards

FITS MODEL	PART #
GASGAS	
MC 125/250 24-25, MC 150/300 25, MC 250F/350F/450F 24-25	1711-2327
HUSQVARNA	
TC 125/250 23-25, TC 150/300 25, FC 250/350/450 23-25, TE 125 25, TE 150/250/300 24-25, FE 250/350/450/501 24-25	1711-2327

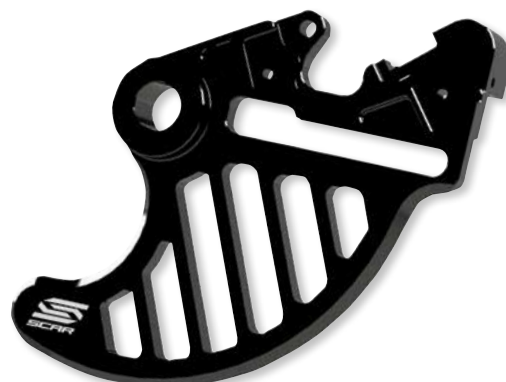

FITS MODEL	PART #
KTM	
SX 125/250/300 23-25, SX 150 25, SX-F 250/350/450 23-25, EXC 125/250/300 24-25, EXC-F 250/350/450/500 24-25	1711-2327



REAR DISC GUARD

- CNC-machined design, made of 10 mm thick aluminum affixed to 12 mm thick plastic (HDPE)
- Aluminum allows a strong fixation while the hard plastic provides good protection to your bike
- Thanks to the flexibility of the plastic, your disc brake will be protected all the way without any risk of being blocked by a bent part as aluminum could be

FITS MODEL	PART #	FITS MODEL	PART #	FITS MODEL	PART #
GASGAS		HUSQVARNA (CONT)		SHERCO	
MC 150-450F 21-25	1703-0127	FE 250/350/450/501 14-25	1703-0127	SC 250/300 Factory 12-20	1703-0127
EC 250-450F 21-25	1703-0127	KTM		SE 250/300 Factory/Racing 12-25	1703-0127
HUSQVARNA		SX 125/250 12-25	1703-0127	SEF 250/300 Factory 12-25	1703-0127
TC 125/250 14-25	1703-0127	SX-F 250/350/450 12-25	1703-0127		
FC 250/350/450 14-25	1703-0127	EXC 250/300 12-25	1703-0127		
TE 125/250 14-25	1703-0127	EXC-F 250/350/450 12-25	1703-0127		



EXHAUST

LUGGAGE

BIKE STANDS & ACCESSORIES

HANDLEBARS & HAND CONTROLS

FOOTPEGS & FOOT CONTROLS

BODY

GRAPHICS & SEATS

SPROCKETS

CHAINS

BRAKES

WHEELS & ACCESSORIES

SUSPENSION

ELECTRICAL & GAUGES

LIGHTING

ENGINE

FUEL/AIR SYSTEMS

HARDWARE & MERCHANDISING



EXHAUST

LUGGAGE

BIKE STANDS & ACCESSORIES

HANDLEBARS & HAND CONTROLS

FOOTPEGS & FOOT CONTROLS

BODY

GRAPHICS & SEATS

SPROCKETS

CHAINS

BRAKES

WHEELS & ACCESSORIES

SUSPENSION

ELECTRICAL & GAUGES

LIGHTING

ENGINE

FUEL/AIR SYSTEMS

HARDWARE & MERCHANDISING

REAR BRAKE RESERVOIR COOLING EXTENSIONS

- Increases the amount of brake fluid in rear reservoir
- Reduces brake fade
- CNC-machined
- Can be fitted in seconds
- Includes rubber gasket

- Anodized black finish resists corrosion
- See page 951 of the 2024 Parts Europe Offroad catalog for the complete line of SCAR rear brake reservoir cooling extensions

1701-0779



FITS MODEL	PART #
GASGAS	
MC 125/250 24-25, MC 250F/350F/450F 24-25	1701-0779
EC 250/300/350F 21-25, EC 450F/500F 24-25	1701-0779
HUSABERG	
TE 250/300, FE 250/350/501	0601-6805
HUSQVARNA	
TC 125/250/300 14-15, 17-25, TC 150 25	0601-6805

FITS MODEL	PART #
HUSQVARNA (CONT)	
TE 125/250/300 14-17, FE 350/450/501 14-17	0601-6805
TE 150/250/300 23-24, FE 250/350 23-24, FE 450/501 23-25	1701-0779
KTM	
SX/SX-F/EXC 125-525 04-25	0601-6805
SHERCO	
SE/SE-R 125/250/300, SEF/SEF-R 250/300/450 10-25	0601-6805

FITS MODEL	PART #
STARK	
Varg 23-25	0601-6805
TM	
MX/EN 125/144/250/300/450 15-25	0601-6805
TRIUMPH	
TF 250-X 24-25	0601-6805



STAINLESS STEEL BRAIDED BRAKE LINES

- Swivel union ends are the secret to easier fitting, and ensure a kink- and stress-free installation
- Venhill Engineering in the UK makes Moose Racing Stainless Steel Brake lines to the highest specifications
- Each line is made from top-quality PTFE-coated hose, wrapped with British-made stainless steel and PVC-coated for protection and great looks
- Rubber protection boots and extra rigid tubing are used to protect vulnerable areas from heat and impact and to prevent hose flex under compression

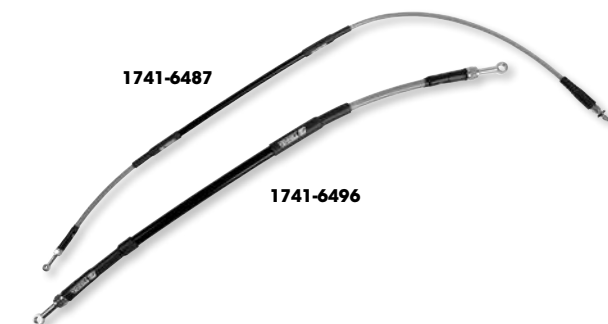

- Each line is designed to withstand a minimum of 14,000 psi
- Installing our stainless lines gives a large performance increase by significantly reducing expansion under pressure, and absorption of water when compared to stock rubber hoses
- See page 954 of the 2024 Parts Europe Offroad catalog for Moose Racing's complete line of stainless steel braided brake lines

FITS MODEL	FRONT BRAKE LINE PART #	REAR BRAKE LINE PART #
GASGAS		
MC 50 21-23	1741-6487	1741-6496
MC 50 24-25	1741-6487	-
MC 65 21-22	1741-6486	1741-6498
MC 65 23-25	1741-6491	1741-6501
MC 85 21-24 (all)	1741-6484	1741-6499
MC 125 03-04	-	1741-6406
MC 125 05-09	1741-6404	1741-6406
MC 125 21-23	-	1741-6494
MC 125 24-25	-	1741-6450
MC 150 25	-	1741-6450
MC 250 03-04	-	1741-6406
MC 250 05-10	1741-6404	1741-6406
MC 250 22-23	-	1741-6494
MC 250 24-25	-	1741-6450
MC 300 25	-	1741-6450
MC 250F 21-23	-	1741-6494
MC 250F 24-25	-	1741-6450
MC 350F 22-23	-	1741-6494
MC 350F 24-25	-	1741-6450
MC 450F 21-23	-	1741-6494
MC 450F 24-25	-	1741-6450
EC 125 03-11	1741-6404	1741-6406
EC 125 Race 13-15	1741-6404	1741-6406
EC 200 03-19	1741-6404	1741-6406
EC 200 Race 13-15	1741-6404	1741-6406
EC 250 00-19	1741-6404	1741-6406
EC 250 Race 12-18	1741-6404	1741-6406
EnduroGP 250 18	1741-6404	1741-6406
EC 250 21-24	1741-6440	1741-6450
EC 300 00-19	1741-6404	1741-6406
EC 300 Race 12-18	1741-6404	1741-6406
EnduroGP 300 18	1741-6404	1741-6406
EC 300 21-24	1741-6440	1741-6450
EC 450 09	1741-6404	1741-6406
EC 515 09	1741-6404	1741-6406
EC 250F 10-15	1741-6404	1741-6406
EC 250F Race 13-15	1741-6404	1741-6406
EC 250F 21-24	1741-6440	1741-6450

FITS MODEL	FRONT BRAKE LINE PART #	REAR BRAKE LINE PART #
GASGAS (CONT)		
EC 300F 13-15	1741-6404	1741-6406
EC 300F Race 13-14	1741-6404	1741-6406
EC 350F 21-24	1741-6440	1741-6450
EC 450FSR 09	1741-6404	1741-6406
EC 450F Race 12-14	1741-6404	1741-6406
EC 450F 14-15	1741-6404	1741-6406
EC 450F 24	1741-6440	1741-6450
EC 500F 24	1741-6440	1741-6450
EW 500F 24	1741-6440	1741-6450
FSE 400 03-05	1741-6404	1741-6406
FSE 450 03-08	1741-6404	1741-6406
TXT Rookie 05 (all)	-	1741-6407
TXT Racing 80 Pro 15	-	1741-6407
TXT GP 125 17-18	1741-6405	-
TXT 125 Pro 11	1741-6405	1741-6407
TXT 125 Pro 13-14	1741-6405	1741-6407
TXT Racing 125 11	-	1741-6407
TXT Racing 125 13-15	1741-6405	1741-6407
TXT Racing 125 17-18	1741-6405	-
TXT Racing 125 19-22	1741-6405	1741-6408
TXT 125-300 Raga Replica 11-12	-	1741-6407
TXT 250 Pro 11-14	1741-6405	1741-6407
TXT Racing 250 13-15	1741-6405	1741-6407
TXT Racing 250 17-18	1741-6405	-
TXT Racing 250 19-22	1741-6405	1741-6408
TXT 280 Pro 11	1741-6405	1741-6407
TXT 280 Pro 13-14	1741-6405	1741-6407
TXT Racing 280 11	-	1741-6407
TXT Racing 280 13-15	1741-6405	1741-6407
TXT Racing 280 17-18	1741-6405	-
TXT Racing 280 19-22	1741-6405	1741-6408
TXT 300 Pro 11	1741-6405	1741-6407
TXT 300 Pro 13-14	1741-6405	1741-6407
TXT Racing 300 11	-	1741-6407
TXT Racing 300 13-15	1741-6405	1741-6407
TXT Racing 300 17-18	1741-6405	-
TXT Racing 300 19-22	1741-6405	1741-6408

FITS MODEL	FRONT BRAKE LINE PART #	REAR BRAKE LINE PART #
HONDA		
CRF 150R 18-25	-	1741-6478
CRF 150RB 18-25	-	1741-6479
CRF 250L 13-20	1741-6463	1741-6473
CRF 250M 14-15	-	1741-6473
CRF 250R 08	-	1741-6470
CRF 250R 09	1741-6461	1741-6470
CRF 250R 10-13	1741-6461	1741-6471
CRF 250R 14	1741-6461	1741-6472
CRF 250R 15	1741-6462	1741-6472
CRF 250R 16-17	1741-6458	1741-6472
CRF 250R 18	1741-6465	1741-6475
CRF 250R 19	1741-6460	1741-6475
CRF 250R 20-24	1741-6460	1741-6476
CRF 250R 25	1741-6460	-
CRF 250RL (non-ABS) 17-20	1741-6467	1741-6473
CRF 250RWE 25	1741-6460	-
CRF 300L 21-22	1741-6466	1741-6480
CRF 300LR 21-22	1741-6467	1741-6480
CRF 450R 05	1741-0251	-
CRF 450R 06-08	1741-0980	-
CRF 450R 09-13	1741-6461	1741-6471
CRF 450R 14	1741-6461	1741-6472
CRF 450R 15	1741-6462	1741-6472
CRF 450R 16	1741-6458	1741-6472
CRF 450R 17-18	1741-6465	1741-6475
CRF 450R 19-22	1741-6460	1741-6476
CRF 450R 23-25	1741-6460	-
CRF 450RWE 19-22	1741-6460	1741-6476
CRF 450RWE 23-25	1741-6460	-
CRF 150F 03-17	1741-6464	-
CRF 250F 19-25	1741-6468	1741-6481
CRF 250RX 19	1741-6460	1741-6475
CRF 250RX 20-24	1741-6460	1741-6476
CRF 250RX 25	1741-6460	-
CRF 250X 04-06	1741-6457	-
CRF 250X 07-17	1741-6459	-
CRF 450RX 17-18	1741-6465	1741-6475



STAINLESS STEEL BRAIDED BRAKE LINES (CONT)

FITS MODEL	FRONT BRAKE LINE PART #	REAR BRAKE LINE PART #
HONDA (CONT)		
CRF 450RX 19-22	1741-6460	1741-6476
CRF 450RX 23-25	1741-6460	-
CRF 450X 05-08	1741-6457	-
CRF 450X 09-17	1741-6459	-
CRF 450X 19-25	1741-6456	1741-6477
XR 650L 93-13	-	1741-6474
XR 650R 00-07	-	1741-6469
HUSABERG		
TE 125 12-13	-	1741-6497
TE 250 11-14	-	1741-6497
TE 300 11-14	-	1741-6497
FE 250 13-14	-	1741-6497
FE 350 13-14	-	1741-6497
FE 390 10-12	-	1741-6497
FE 450 04-14	-	1741-6497
FE 501 13-14	-	1741-6497
FE 570 09-12	-	1741-6497
HUSQVARNA		
EE 5 20-23	1741-6487	1741-6496
TC 50 17-23	1741-6487	1741-6496
TC 50 Mini 18-23	1741-6489	1741-6500
TC 65 17-22	1741-6486	1741-6498
TC 65 23	1741-6491	1741-6501
TC 85 14-17 (all)	1741-6485	1741-6492
TC 85 18-20 (all)	1741-6482	1741-6492
TC 85 21-24 (all)	1741-6484	1741-6499
TC 125 14-17	-	1741-6494
TC 125 18	1741-6434	1741-6451
TC 125 19-24	-	1741-6494
TC 250 08-11	1741-6437	1741-6447
TC 250 12	1741-6436	1741-6447
TC 250 13	1741-6437	1741-6447
TC 250 14-17	-	1741-6494
TC 250 18	1741-6434	1741-6451
TC 250 19-24	-	1741-6494
TC 449 11-13	1741-6437	1741-6449
TC 450 04	-	1741-6445
TC 450 06-07	1741-6437	-
TC 450 08-10	1741-6437	1741-6447
TC 450 11-13	1741-6437	1741-6449
TC 510 09-10	1741-6437	1741-6447
TC 511 11-13	1741-6439	1741-6449
FC 250 14-17	-	1741-6494
FC 250 18	1741-6434	1741-6451
FC 250 19-21	-	1741-6494
FC 250 (Brembo brakes) 22-24	-	1741-6494
FC 350 14-17	-	1741-6494
FC 350 18	1741-6434	1741-6451
FC 350 19-24	-	1741-6494
FC 450 (Brembo Brakes) 14-24	-	1741-6494
FC 450 (Magura Brakes) 18	1741-6434	1741-6451
TE 125 14-16	-	1741-6494
TE 150 17	1741-6488	1741-6494
TE 150 18-21	1741-6438	1741-6451
TE 150 22-24	1741-6440	1741-6450
TE 250 04-05	1741-6435	1741-6445
TE 250 08-12	1741-6436	1741-6447
TE 250 13	1741-6437	1741-6447
TE 250 14-16	-	1741-6494
TE 250 17	1741-6488	1741-6494
TE 250 18-21	1741-6438	1741-6451
TE 250 22-24	1741-6440	1741-6450
TE 300 14-16	-	1741-6494
TE 300 17	1741-6488	1741-6494
TE 300 18-21	1741-6438	1741-6451
TE 300 22-24	1741-6440	1741-6450
TE 300 Pro 24	1741-6488	1741-6494
TE 310 09-12	1741-6436	1741-6447
TE 310 13	1741-6437	1741-6447
TE 410 95	1741-6429	-
TE 410 96-99	1741-6430	-
TE 410 00	1741-6432	-
TE 449 11-13	1741-6439	1741-6449
TE 450 04	-	1741-6445

FITS MODEL	FRONT BRAKE LINE PART #	REAR BRAKE LINE PART #
HUSQVARNA (CONT)		
TE 450 05	1741-6435	1741-6445
TE 450 06-07	1741-6436	-
TE 450 08-10	1741-6436	1741-6447
TE 450 11-13	1741-6439	1741-6449
TE 510 04-05	1741-6435	1741-6445
TE 510 06-07	1741-6436	-
TE 510 08-10	1741-6436	1741-6447
TE 511 11-12	1741-6439	1741-6449
TE 511 13	1741-6437	1741-6449
TE 610E 99-05	-	1741-6444
FE 250 14-16	-	1741-6494
FE 250 17	1741-6488	1741-6494
FE 250 18-21	1741-6438	1741-6451
FE 250 22-24	1741-6440	1741-6450
FE 350 14-16	-	1741-6494
FE 350 17	1741-6488	1741-6494
FE 350 18-21	1741-6438	1741-6451
FE 350 22-24	1741-6440	1741-6450
FE 350 Pro 24	1741-6488	1741-6494
FE 450 14-16	-	1741-6494
FE 450 17	1741-6488	1741-6494
FE 450 18-21	1741-6438	1741-6451
FE 450 22-24	1741-6440	1741-6450
FE 501 14-16	-	1741-6494
FE 501 17	1741-6488	1741-6494
FE 501 18-21	1741-6438	1741-6451
FE 501 22-24	1741-6440	1741-6450
CR 125 92-99	-	1741-6441
CR 125 00	-	1741-6442
CR 125 09-13	1741-6437	1741-6448
CR 250 92-00	-	1741-6441
TXC 250 10-11	1741-6437	1741-6447
TXC 250 12	1741-6436	1741-6447
TXC 250 13	1741-6437	1741-6447
TXC 310 12	1741-6436	1741-6447
TXC 310 13	1741-6437	1741-6447
TXC 510 08-09	1741-6437	1741-6447
WR 125 98-01	-	1741-6443
WR 125 02-05	1741-6433	1741-6443
WR 125 09-12	1741-6436	1741-6448
WR 250 06-12	-	1741-6446
WR 300 09-12	-	1741-6446
WR 360 92-95	1741-6429	-
WR 360 96-98	1741-6430	-
WRE 125 05-06	1741-6432	-
WRE 125 07-10	1741-6432	1741-6442
WRE 125 11	-	1741-6442
KAWASAKI		
KX 65 01-02	1741-6523	1741-6524
KX 65 02-11	1741-6541	1741-6552
KX 65 12-25	1741-6545	1741-6554
KX 80 BW 91-94	-	1741-6548
KX 85 12-13	1741-6535	1741-6536
KX 85 BW 12-13	1741-6535	1741-6526
KX 85 14-25	1741-6525	1741-6536
KX 85 BW 14-25	1741-6525	1741-6526
KX 100 91-11	-	1741-6548
KX 100 12-13	1741-6535	1741-6526
KX 100 14-21	1741-6525	1741-6526
KX 112 22-25	1741-6525	1741-6526
KX 125 96	1741-6521	-
KX 125 03	-	1741-6549
KX 125 04	-	1741-6549
KX 250 96	1741-6521	-
KX 250 03	-	1741-6549
KX 500 96-02	1741-6521	1741-6522
KX 500 03-04	1741-6521	-
KX 250F 06-11	-	1741-6495
KX 250F 12	1741-6543	1741-6553
KX 250F 13-18	1741-6544	1741-6553
KX 250F 19	1741-6544	1741-6553
KX 250 20	1741-6544	1741-6550
KX 250 21-24	1741-6546	1741-6550
KX 450F 06-11	-	1741-6495
KX 450F 12	1741-6543	1741-6553
KX 450F 13-18	1741-6544	1741-6553

FITS MODEL	FRONT BRAKE LINE PART #	REAR BRAKE LINE PART #
KAWASAKI (CONT)		
KX 450 19-23	1741-6546	1741-6550
KX 450SR 22-23	1741-6546	1741-6550
KLX 140 08-24	1741-6540	1741-6547
KLX 140F 21-24	1741-6519	1741-6520
KLX 140G 17-24	1741-6519	1741-6520
KLX 140L 08-24	1741-6540	1741-6547
KLX 230 (Non ABS) 20-23	1741-6527	1741-6528
KLX 230R (Non ABS) 20-24	1741-6537	1741-6538
KLX 230RS (Non ABS) 22-23	1741-6537	1741-6538
KLX 230S (Non ABS) 22-23	-	1741-6528
KLX 250 06-07	-	1741-6532
KLX 250S 09-13	1741-6531	1741-6532
KLX 250S 14	1741-6533	1741-6534
KLX 250SF 09-10	-	1741-6532
KLX 300 21-23	1741-6533	1741-6534
KLX 300 24	-	1741-6534
KLX 300R 97-07	1741-6539	1741-6532
KLX 300R 20-24	1741-6542	1741-6555
KLX 650R 96 (D1)	1741-6539	-
KLX 650R 99 (D4)	1741-6539	-
KDX 200 95-05	1741-6529	1741-6530
KDX 200 06	1741-6529	-
KDX 200R 97-01	1741-6529	1741-6530
KDX 220R 02-04	1741-6529	1741-6530
KDX 220R 05	1741-6529	-
KTM		
SX-E 5 20-23	1741-6487	1741-6496
SX 50 06-23	1741-6487	1741-6496
SX 50 Mini 08	1741-6489	-
SX 50 Mini 09-23	1741-6489	1741-6500
SX 50 Mini Pro Junior LC 02-05	1741-6489	-
SX 50 Mini Pro Senior LC 02-03	1741-6487	-
SX 50 Mini Pro Senior LC 04-05	1741-6487	1741-6496
SX 65 04-05	1741-6483	1741-6493
SX 65 06-08	1741-6486	1741-6493
SX 65 09-22	1741-6486	1741-6498
SX 65 23-24	1741-6491	1741-6501
SX 85 03-12	-	1741-6492
SX 85 13-17	1741-6485	1741-6492
SX 85 18-20	1741-6482	1741-6492
SX 85 21-24	1741-6484	1741-6499
SX 105 04-05	-	1741-6497
SX 105 06-12	-	1741-6492
SX 125 04-11	-	1741-6497
SX 125 12-25	-	1741-6494
SX 144 08	-	1741-6497
SX 150 09-12	-	1741-6497
SX 150 13-22, 25	-	1741-6494
SX 200 04	-	1741-6497
SX 250 03-12	-	1741-6497
SX 250 13-15	-	1741-6494
SX 250 16	-	1741-6497
SX 250 17-25	-	1741-6494
SX 300 23-25	-	1741-6494
SX 450 03-06	-	1741-6497
SX-F 250 05-10	-	1741-6497
SX-F 250 11-25	-	1741-6494
SX-F 350 11-25	-	1741-6494
SX-F 450 07-10	-	1741-6497
SX-F 450 11-25	-	1741-6494
SX-F 505 07-08	-	1741-6497
SXS-F 250 07-08	-	1741-6497
SXS-F 450 07-08	-	1741-6497
EXC 125 04-05	-	1741-6497
EXC 150 17-23	1741-6488	1741-6497
EXC 200 04-16	-	1741-6497
EXC 250 04-16	-	1741-6497
EXC 250 17-23	1741-6488	1741-6497
EXC 250 24	1741-6488	1741-6494
EXC 400 03-12	-	1741-6497
EXC 450 03-16	-	1741-6497

EXHAUST

LUGGAGE

BIKE STANDS & ACCESSORIES

HANDLEBARS & HAND CONTROLS

FOOTPEGS & FOOT CONTROLS

BODY

GRAPHICS & SEATS

SPROCKETS

CHAINS

BRAKES

WHEELS & ACCESSORIES

SUSPENSION

ELECTRICAL & GAUGES

LIGHTING

ENGINE

FUEL/AIR SYSTEMS

HARDWARE & MERCHANDISING

STAINLESS STEEL BRAIDED BRAKE LINES continued on next page.



STAINLESS STEEL BRAIDED BRAKE LINES (CONT)

EXHAUST

LUGGAGE

BIKE STANDS & ACCESSORIES

HANDLEBARS & HAND CONTROLS

FOOTPEGS & FOOT CONTROLS

BODY

GRAPHICS & SEATS

SPROCKETS

CHAINS

BRAKES

WHEELS & ACCESSORIES

SUSPENSION

ELECTRICAL & GAUGES

LIGHTING

ENGINE

FUEL/AIR SYSTEMS

HARDWARE & MERCHANDISING

FITS MODEL	FRONT BRAKE LINE PART #	REAR BRAKE LINE PART #
KTM (CONT)		
EXC 500 12-16	-	1741-6497
EXC 530 09-12	-	1741-6497
EXC-F 250 06-16	-	1741-6497
EXC-F 250 17-23	1741-6488	1741-6497
EXC-F 250 24	1741-6488	1741-6494
EXC-F 350 12	-	1741-6494
EXC-F 350 13-16	-	1741-6497
EXC-F 350 17-23	1741-6488	1741-6497
EXC-F 450 17-22	1741-6488	1741-6497
EXC-F 500/Six Days 17-23	1741-6488	1741-6497
EXC-R 450 08	-	1741-6497
SMR 450 14-23	1741-6490	1741-6494
SUZUKI		
RM 65 03	1741-6541	1741-6524
RM 65 04	1741-6541	-
RM 65 05	1741-6541	-
RM 85L BW 03-12	-	1741-6454
RM 85L BW 13-22	1741-6453	1741-6454

FITS MODEL	FRONT BRAKE LINE PART #	REAR BRAKE LINE PART #
SUZUKI (CONT)		
RM 100 03	-	1741-6548
RM 125 04-08	1741-0985	-
RM-Z 250 07-09	-	1741-0988
RM-Z 250 10-15	-	1741-6428
RM-Z 250 16-18	-	1741-6805
RM-Z 250 19-24	1741-6424	1741-6425
RM-Z 450 05-07	-	1741-0988
RM-Z 450 08-15	-	1741-6428
RM-Z 450 18-24	1741-6424	1741-6425
RMX 450Z 10-19	1741-6427	1741-6428
DR-Z 125L 12-24	1741-6452	-
DR-Z 400E 00-07	-	MS01-2027
DR-Z 400S 00-04	-	1741-6804
DR-Z 400S 05-24	1741-6426	1741-6804
YAMAHA		
YZ 65 18-25	-	1741-6420
YZ 85 03-18	-	-
YZ 85 19-21	1741-6416	1741-6422

FITS MODEL	FRONT BRAKE LINE PART #	REAR BRAKE LINE PART #
YAMAHA (CONT)		
YZ 85 22-25	1741-6416	1741-6423
YZ 125 22-25	-	1741-6421
YZ 250 22-24	-	1741-6421
YZ 250F 14-20	1741-6412	-
YZ 250F 21-23	1741-6412	1741-6421
YZ 450F 14-19	1741-6412	-
YZ 450F 20-22	1741-6412	1741-6421
WR 250F 15-16	1741-6413	-
WR 250F 17-19	1741-6410	-
WR 250F 20-23	1741-6415	-
WR 250F 24	1741-6415	1741-6811
WR 250F 25	1741-6415	1741-6421
WR 250R 08-20	1741-6409	1741-6417
WR 450F 12-15	1741-6413	1741-6419
WR 450F 16-18	1741-6410	-
WR 450F 19-23	1741-6415	-
WR 450F 24-25	1741-6415	1741-6421
XT 250 08-25	1741-6411	1741-6418



Front



Rear



OEM REPLACEMENT STAINLESS STEEL BRAKE LINES

- Developed to replace the bike's original brake line, this braided stainless steel brake line is a great improvement for any brake system
- Protected with a durable yet lightweight PVC covering, which allows it to stand up to heavy abuse while also providing a tremendous increase in feel and response due to reduced flex over a standard OEM plastic line
- The banjos are in rust-free stainless steel, swaged-pressed and turnable to allow torsion-free mounting on the bike without the risk of a banjo coming loose

- All lines come packaged with the necessary mounting hardware including banjo bolts and copper washers, along with fitment instructions to help with installation
- For the full line of Moto-Master OEM Replacement stainless steel brake lines see pages 955-958 of the 2024 Parts Europe Offroad catalog

FITS MODEL	FRONT PART #	REAR PART #
GASGAS		
MC 85 21-24 (all)	1741-6378	1741-6394
MC 125 05-13	1741-6374	-
MC 200 99-13	1741-6374	-
MC 250 99-11	1741-6374	-
MC 300 00-12	1741-6374	-
MC 250F 12-14	1741-6374	1741-6392
MC 400F 02-03	1741-6374	-
MC 450F 03-14	1741-6374	-
MC 515F 08-10	1741-6374	-
EC 125 05-15	1741-6374	-
EC 200/e Racing/Hobby/R 00-20	1741-6374	-
EC 250 00-20	1741-6374	-
EC 250F 12-15	1741-6374	1741-6392
EC 300/F/R/ GP Replica 99-20	1741-6374	-
EC 400F 02-03	1741-6374	-

FITS MODEL	FRONT PART #	REAR PART #
GASGAS (CONT)		
EC 450F 03-15	1741-6374	-
EC 515F 08-10	1741-6374	-
HUSQVARNA		
TC 85 18-20 (all)	1741-6376	-
TC 85 21-24 (all)	1741-6378	1741-6394
KAWASAKI		
KX 250 21-25	1741-6372	-
KX 450 19-25	1741-6372	-
KTM		
SX 85 18-20 (all)	1741-6376	-
SX 85 22-24 (all)	1741-6378	1741-6394
RIEJU		
MR 200 Racing/Ranger 23-24	1741-6374	1741-6392
MR 250 Pro/Racing 21-24	1741-6374	1741-6392

FITS MODEL	FRONT PART #	REAR PART #
RIEJU (CONT)		
MR 300 Pro/Racing/Ranger/Six Days 21-24	1741-6374	-
TM		
MX 125-530 (all) 13-24	1741-6402	1741-6401
EN 125-530 (all) 13-24	1741-6402	1741-6401
YAMAHA		
YZ 85 LW 19-25	-	1741-6393
YZ 125 22-25	-	1741-6397
YZ 250 22-25	-	1741-6397
YZ 250F 21-23	-	1741-6397
YZ 250F 24-25	1741-6403	1741-6397
YZ 450F 20-22	-	1741-6397
YZ 450F 23-24	1741-6403	1741-6397
WR 250F 16-19	1741-6377	-
WR 450F 16-18	1741-6377	-



BRAKE LINE BANJO CONNECTOR

- Required to complete brake line assembly
- Sold each
- See pages 960-961 of the 2024 Parts Europe Offroad catalog for the complete line of TRW Brake Line Banjo Bolts, Fittings and Adapters

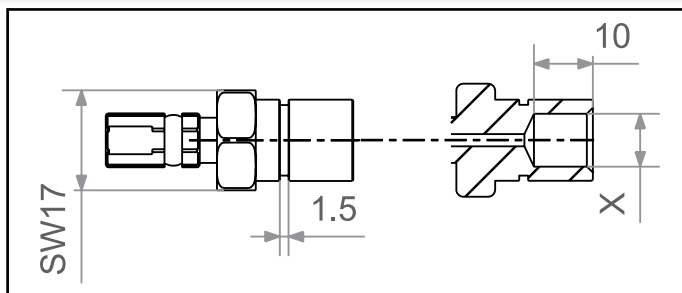

COLOR	PART #
M10 X 1,00 SHORT STRAIGHT HOSE END W/ FEMALE FITTING	
Stainless steel	1742-0521



CLUTCH MASTER CYLINDER REPAIR KITS

- Kits contain all of the components to rebuild leaking master cylinders
- Include replacement hard anodized aluminum piston, replacement cover screws, boot and spring
- See pages 971-972 of the 2024 Parts Europe Offroad catalog for Moose Racing's complete line of clutch master cylinder repair kits

FITS MODEL	PART #	FITS MODEL	PART #	FITS MODEL	PART #
GASGAS		HUSQVARNA (CONT)		SHERCO (CONT)	
MC 125 24	1132-1962	FE 450 23-24	1132-1962	SEF-R 300 Factory 16-19	1132-1960
MC 250 24	1132-1962	FE 450 Heritage Edition 23	1132-1962	SEF-R 300 Six Days 18	1132-1960
MC 350F 23-24 (Braktec)	1132-1962	FE 501 22-23	1132-1962	SEF-R 450 15-20	1132-1960
MC 450F (Braktec) 23-24	1132-1962	SHERCO		SEF-R 450 21	1132-1961
MC 450F 24	1132-1962	SE 125 Factory 21-23	1132-1961	SEF-R 450 Factory 16-19	1132-1960
MC 450F Factory Edition 24	1132-1962	SE 250 13	1132-1960	SEF-R 450 Six Days 18	1132-1960
EC 250 24	1132-1962	SE 250 Factory 23	1132-1961	SE-R 125 18-19, 21	1132-1961
EC 300 21-24	1132-1962	SE 250 I 13	1132-1960	SE-R 125 Six Days 18	1132-1961
EC 450F 24	1132-1962	SE 250 Racing 21-22	1132-1961	SE-R 250 14-20	1132-1960
EW 500F 24	1132-1962	SE 300 13	1132-1960	SE-R 250 Factory 16-20	1132-1960
HUSQVARNA		SE 300 Factory 21-23	1132-1961	SE-R 250 Factory 21	1132-1961
FC 450 23-24 (Braktec)	1132-1962	SE 300i 13	1132-1960	SE-R 250i 12-13	1132-1960
FC 450 Heritage Edition 23	1132-1962	SEF 450 Factory 23	1132-1961	SE-R 300 14-20	1132-1960
TE 150 22	1132-1962	SEF 500 Factory 21-23	1132-1961	SE-R 300 21	1132-1961
TE 150 Heritage Edition 23	1132-1962	SEF-R 250 14-18	1132-1960	SE-R 300 Factory 16-18	1132-1960
TE 250 22-23	1132-1962	SEF-R 250 Factory 16-19	1132-1960	SE-R 300 Six Days 18	1132-1960
TE 300 22-24	1132-1962	SEF-R 250 Six Days 18	1132-1960	SE-R 300i 13	1132-1960
FE 350 22-23	1132-1962	SEF-R 300 14-18	1132-1960		



SLAVE CYLINDER REBUILD KIT

- Kit contains all of the components to rebuild leaking slave cylinder
- Kit includes copper washer, seal, O-rings, gaskets, spring and screws
- See pages 972-973 of the 2024 Parts Europe Offroad catalog for the complete line of Moose Racing slave cylinder rebuild kits

FITS MODEL	PART #	FITS MODEL	PART #
HUSQVARNA		KTM (CONT)	
FC 350 23-24	0950-1028	350 SX-F 23-24	0950-1028
FC 350 Heritage Edition 23	0950-1028	450 SX-F 23-24	0950-1028
FC 450 Rockstar Edition 22-24	0950-1028	250 EXC-F 23-24	0950-1028
KTM		350 EXC-F 23	0950-1028
250 SX-F 23-24	0950-1028	450 EXC-F 23-24	0950-1028



- EXHAUST
- LUGGAGE
- BIKE STANDS & ACCESSORIES
- HANDLEBARS & HAND CONTROLS
- FOOTPEGS & FOOT CONTROLS
- BODY
- GRAPHICS & SEATS
- SPROCKETS
- CHAINS
- BRAKES**
- WHEELS & ACCESSORIES
- SUSPENSION
- ELECTRICAL & GAUGES
- LIGHTING
- ENGINE
- FUEL/AIR SYSTEMS
- HARDWARE & MERCHANDISING



EXHAUST

LUGGAGE

BIKE STANDS & ACCESSORIES

HANDLEBARS & HAND CONTROLS

FOOTPEGS & FOOT CONTROLS

BODY

GRAPHICS & SEATS

SPROCKETS

CHAINS

BRAKES

WHEELS & ACCESSORIES

SUSPENSION

ELECTRICAL & GAUGES

LIGHTING

ENGINE

FUEL/AIR SYSTEMS

HARDWARE & MERCHANDISING



SX-1 COMPLETE MINI WHEELS

- Moose hubs are made from forged 6061 T6 aluminum with a high-quality gray anodized finish that doesn't fade
- Our stainless steel spokes are made from T3002H stainless for maximum tensile strength
- Moose uses extruded 7000 series aluminum for best durability and strength
- Rims are treated with a 3-stage heat treatment process for added strength
- Wheels come complete with OEM-style spacers
- All spokes are polished to maintain surface strength
- See page 977 of the 2024 Parts Europe Offroad catalog for the complete line of Moose Racing SX-1 complete mini wheels

FITS MODEL	WHEEL SIZE	HUB COLOR	PART #
GASGAS			
MC 85 21-25	14x1,60	Gray	0204-0685
	16x1,85	Gray	0204-0686
HUSQVARNA			
TC 85 21-25	14x1,60	Gray	0204-0685
	16x1,85	Gray	0204-0686

FITS MODEL	WHEEL SIZE	HUB COLOR	PART #
KTM			
SX 85 21-25	14x1,60	Gray	0204-0685
	16x1,85	Gray	0204-0686



COATED STEEL SPOKE SET

- Chrome-plated steel spokes are interchangeable with Moose and stock rims and hubs
- #45 grade steel meets or exceeds OEM standards
- Consistent-diameter design offers superior strength over stock
- Spokes come with matching nipples
- Sold in sets or individually
- See pages 978-979 of the 2024 Parts Europe Offroad catalog for Moose Racing's complete line of spokes and spoke sets

COATED STEEL SPOKES

FITS MODEL	SIZE	PART #
KAWASAKI		
KLR 650 08-25	21"	0211-0110

REAR WHEEL BEARINGS AND SEAL KITS

- Kit includes all bearings and seals to refit a wheel
- Premium high-speed bearings with low-drag double-lip seals and nitrile elastomer outer seals to keep water and dirt out, extending bearing life
- Packed with Chevron SR1-2 high-performance grease with rust and oxidation inhibitors
- Kits are per wheel
- See pages 996-1001 of the 2024 Parts Europe Offroad catalog for the complete line of Moose Racing wheel bearings and seal kits



FITS MODEL	PART #	FITS MODEL	PART #	FITS MODEL	PART #	FITS MODEL	PART #
HONDA		HONDA (CONT)		HONDA (CONT)		YAMAHA (CONT)	
CT 70 Trail 69-94	A25-1300	XL 75 77-79	A25-1300	XR 80 79-84	A25-1300	XT 125 82-83	A25-1189
CT 110 Trail 80-86	A25-1300	XL 80S 80-85	A25-1300	XR 100 81-84	A25-1300	XT 200 82-83	A25-1189
SL 70 71-73	A25-1300	XL 100S 81-85	A25-1300	YAMAHA		XT 225 92-07	A25-1189
XL 70 76	A25-1300	XR 75 73-78	A25-1300	TT 225 86-87	A25-1189	XT 250 08-22	A25-1189

SAFETY WARNING: WHEN SELECTING CUSTOM WHEELS, THE TIRES USED FOR YOUR APPLICATION MUST HAVE A LOAD INDEX AND SPEED RATING EQUAL TO OR GREATER THAN THE TIRES FITTED AS ORIGINAL EQUIPMENT. CONSULT MANUFACTURER'S PUBLICATION(S) AND/OR WEBSITE(S) FOR COMPLETE TIRE INFORMATION.



0222-0715

EXHAUST

LUGGAGE

BIKE STANDS & ACCESSORIES

HANDLEBARS & HAND CONTROLS

FOOTPEGS & FOOT CONTROLS

BODY

GRAPHICS & SEATS

SPROCKETS

CHAINS

BRAKES

WHEELS & ACCESSORIES

SUSPENSION

ELECTRICAL & GAUGES

LIGHTING

ENGINE

FUEL/AIR SYSTEMS

HARDWARE & MERCHANDISING

WHEEL BEARING KITS

- OEM-quality wheel bearings
- Comes with or without seals

WHEEL BEARING KITS (INCLUDES SEALS)

FITS MODEL	FRONT PART #	FRONT/REAR PART #	REAR PART #
BETA			
RR 125 Racing 2T 18-24	0222-0705	-	0222-0715
RR 250/300 Racing 2T 13-24	0222-0705	-	0222-0715
RR 350 4T Racing 10-21	-	-	0222-0715
RR 350 4T Racing 10-24	0222-0705	-	-
RR 390 4T Racing 15-24	-	-	0222-0715
RR 390 4T Racing 17-24	0222-0705	-	-
RR 390/430/4T Racing 15-24	0222-0705	-	0222-0715
RR 480/4T Racing 15-24	0222-0705	-	0222-0715
RR 125 2T 18-24	-	-	0222-0715
RR 200 2T 20-24	-	-	0222-0715
RR 250/300 2T 13-24	-	-	0222-0715
RR 250 4T 07	-	-	0222-0715
RR 350 4T 10-24	-	-	0222-0715
RR 400 4T 10-14	-	-	0222-0715
RR 450 4T 10-14	0222-0705	-	-
RR 498 4T 12-14	0222-0705	-	-
RR 500 4T 12-14	-	-	0222-0715
RR 520 4T 10-11	-	-	0222-0715
RR 525 05-09	0222-0705	-	-
Xtrainer 250 18-24	0222-0705	-	0222-0715
Xtrainer 300 15-24	0222-0705	-	0222-0715
FANTIC			
XX 125 2T 21-24	0222-0697	-	-
XX 250 2T 22-24	0222-0697	-	-
XE 125 2T 21-24	0222-0697	-	-
GASGAS			
MC 85 21-24	0222-0704	0222-0707	-
MC 125 02-07	0222-0703	-	-
MC 125/250F/450F 21-25	0222-0705	0222-0707	-
MC 250 Front: 22-25 Rear: 22-24	0222-0705	0222-0707	-
MC 250 98-09	0222-0703	-	-
MC 350F Front: 22-25 Rear: 22-24	0222-0705	0222-0707	-
EC 125 03-11	0222-0703	-	0222-0709
EC 125 Racing 10-15	-	-	0222-0709
EC 125 Racing 11-15	0222-0703	-	-
EC 125 Six Days 11	0222-0703	-	0222-0709
EC 200 04-15	0222-0703	-	0222-0709
EC 250 04-13	0222-0703	-	0222-0709
EC 250 Front: 22-25 Rear 22-24	0222-0705	0222-0707	-
EC 250F 10-15	-	-	0222-0709
EC 250F 14-15	0222-0703	-	-
EC 250F/350F Front: 22-25 Rear 22-24	0222-0705	0222-0707	-
EC 250GP/300GP 18	0222-0703	-	0222-0710
EC 300 Racing 11-18	0222-0703	-	-
EC 300 Replica Nambotin 11	0222-0703	-	0222-0709
EC 300E 05-14	0222-0703	-	-
EC 300E Front: 22-25 Rear: 22-24	0222-0705	0222-0707	-
EC 300F Racing 12-15	0222-0703	-	-
EC 450F 12-15	0222-0703	-	0222-0709
EC 450F/500F Front: 22-25 Rear: 22-24	0222-0705	0222-0707	-
EC 450FSE 03-07	0222-0703	-	0222-0710
EC 450FSR 08-09	0222-0703	-	0222-0710
HONDA			
CR 125R 96-07	0222-0695	-	-
CR 125R/250R 00-07	-	-	0222-0716
CR 500R 97-01	0222-0695	-	-
CRF 250L 17-20	0222-0690	-	-
CRF 250R 04-25	0222-0695	-	0222-0716
CRF 300L 21-23	0222-0690	-	-

FITS MODEL	FRONT PART #	FRONT/REAR PART #	REAR PART #
HONDA (CONT)			
CRF 450L 99-20	0222-0695	-	-
CRF 450L 19-23	-	-	0222-0716
CRF 450R 02-25	-	-	0222-0716
CRF 450RL 21-25	0222-0695	-	0222-0716
CRF 450RWE 19-25	0222-0695	-	0222-0716
HUSABERG			
TE 125 11-14	-	0222-0707	-
TE 125 13-14	0222-0705	-	-
TE 250/300 11-14	0222-0705	0222-0707	-
FE 250/350 13-14	-	0222-0707	-
FE 390 10-12	0222-0705	0222-0707	-
FE 450 04-12	0222-0705	0222-0707	-
FE 501 13-14	0222-0705	0222-0707	-
FE 550 04-08	-	0222-0707	-
FE 550 13-14	0222-0705	-	-
FE 570 09-12	0222-0705	0222-0707	-
FE 650E 01-08	-	0222-0707	-
FE 650E 04-08	0222-0705	-	-
FS 450 04-08	0222-0705	0222-0707	-
FS 550 05-08	0222-0705	-	-
FS 570 10-11	0222-0705	-	-
FS 650E/C 01-08	-	0222-0707	-
FS 650E/C 04-08	0222-0705	-	-
HUSQVARNA			
TC 85 14-25	0222-0704	0222-0707	-
TC 125/250 14-25	0222-0705	0222-0707	-
TC 200 17-24	0222-0705	-	-
TC 250 03-13	-	-	0222-0714
TC 310 09-12	-	-	0222-0714
TC 450 03-13	-	-	0222-0714
TC 510 05-10	-	-	0222-0714
TC 610 00-01	-	-	0222-0714
FC 250/350/450 14-25	0222-0705	0222-0707	-
FC 550 04-05	0222-0705	-	-
TE 125 14-17	0222-0705	0222-0707	-
TE 150 17-24	-	0222-0707	-
TE 250 03-13	-	-	0222-0714
TE 250/300 14-24	-	0222-0707	-
TE 310 09-13	-	-	0222-0714
TE 400 04-05	-	-	0222-0714
TE 450 11-13	-	-	0222-0714
TE 510 04-13	-	-	0222-0714
TE 570 01-02	-	-	0222-0714
TE 610 00-08	-	-	0222-0714
TE 630 10-11	-	-	0222-0714
FE 250/350 13-24	0222-0705	0222-0707	-
FE 450 14-24	0222-0705	-	-
CR 125 00-13	-	-	0222-0714
CR 150 11	-	-	0222-0714
CR 250 00-03	-	-	0222-0714
WR 125 00-13	-	-	0222-0714
WR 150 11	-	-	0222-0714
WR 300 08-13	-	-	0222-0714
WR 360 00-02	-	-	0222-0714
KAWASAKI			
KX 60 98-03	-	0222-0706	-
KX 65 00-24	-	0222-0706	-
KX 80 88-00	-	0222-0706	-
KX 85 01-24	-	0222-0706	-

WHEEL BEARING KITS continued on next page.



WHEEL BEARING KITS (CONT)

WHEEL BEARING KITS (INCLUDES SEALS) (CONT)

	FITS MODEL	FRONT PART #	FRONT/REAR PART #	REAR PART #	FITS MODEL	FRONT PART #	FRONT/REAR PART #	REAR PART #
EXHAUST	KAWASAKI (CONT)				KTM (CONT)			
	KX 100 98-21	-	0222-0706	-	EXC-F 350 12-25	0222-0705	0222-0707	-
	KX 112 22-24	-	0222-0706	-	EXC-F 450/500 17-25	0222-0705	0222-0707	-
LUGGAGE	KX 125/250 93-08	0222-0696	-	-	EXC-G 525 Racing 03-06	0222-0705	0222-0707	-
	KX 250 21-25	0222-0699	-	-	EXC-R 530 08	0222-0705	-	-
	KX 250F 04-20	0222-0696	-	-	EXC-R 530 08-09	-	0222-0707	-
BIKE STANDS & ACCESSORIES	KX 500E 94-04	0222-0696	-	-	EXE 125 00-02	0222-0695	-	-
	KTM				Freeride 250F 18-20	0222-0704	0222-0707	-
	SX 85 03-11	0222-0690	-	-	Freeride 250R 14-17	0222-0704	-	-
HANDLEBARS & HAND CONTROLS	SX 85 03-25	-	0222-0707	-	Freeride 250R 15-18	-	0222-0707	-
	SX 85 14-25	0222-0704	-	-	Freeride 350 12-17	0222-0704	-	-
	SX 105 04-11	-	0222-0707	-	Freeride 350 12-18	-	0222-0707	-
FOOTPEGS & FOOT CONTROLS	SX 125 95-99	0222-0690	-	-	SXS 85 12-15	0222-0704	0222-0707	-
	SX 125/250/300/380/400 00-02	0222-0695	-	-	SXS 125/250 03-08	0222-0705	0222-0707	-
	SX 125 03-04	0222-0705	-	-	SXS-F 250 06-08	0222-0705	0222-0707	-
BODY	SX 125 03-25	-	0222-0707	-	SHERCO			
	SX 144 07-08	-	0222-0707	-	SE 125 Factory 18-23	-	-	0222-0714
	SX 144 07-09	0222-0705	-	-	SE 125 Factory 18-24	0222-0698	-	-
GRAPHICS & SEATS	SX 150 09-25	0222-0705	0222-0707	-	SE 125/250/300 Factory 24	-	0222-0707	-
	SX 200 03-04	-	0222-0707	-	SE 250/300 Factory 13-23	-	-	0222-0714
	SX 200/250 03-25	0222-0705	-	-	SE 250/300 Factory 13-24	0222-0698	-	-
SPROCKETS	SX 250 94-24	-	0222-0707	-	SEF 250/300 Factory 24	-	0222-0707	-
	SX 250 94-99	0222-0690	-	-	SEF 250 Factory 14-23	-	-	0222-0714
	SX 300 00-02, 23-25	-	0222-0707	-	SEF 300 Factory 14-24	0222-0698	-	-
CHAINS	SX 360 96-97	0222-0690	-	-	SEF 300/450 Factory 16-23	-	-	0222-0714
	SX 380 98-99	0222-0690	-	-	SEF 450 Factory 16-24	0222-0698	-	-
	SX 380 98-02	-	0222-0707	-	SEF 500 Factory 19-24	0222-0698	-	-
BRAKES	SX 400 00-02	-	0222-0707	-	SEF-R 250 14-18	0222-0698	-	-
	SX 450/525 03-06	0222-0705	0222-0707	-	SEF-R 250 14-23	-	-	0222-0714
	SX 450 Racing 03-06	-	0222-0707	-	SEF-R 300 14-24	0222-0698	-	-
WHEELS & ACCESSORIES	SX 520 01-02	0222-0695	-	-	SEF-R 300/450 16-23	-	-	0222-0714
	SX 520 Racing 00-02	-	0222-0707	-	SEF-R 450 16-24	0222-0698	-	-
	SX 520 Racing 01	0222-0695	-	-	SER 125 18-23	-	-	0222-0714
SUSPENSION	SX-F 250 05-25	0222-0705	0222-0707	-	SER 125 18-24	0222-0698	-	-
	SX-F 250 Factory Edition 22-25	0222-0705	0222-0707	-	SER 250 13-23	-	-	0222-0714
	SX-F 350 11-25	0222-0705	0222-0707	-	SER 250 14-18	0222-0698	-	-
ELECTRICAL & GAUGES	SX-F 450 05-25	-	0222-0707	-	SER 300 14-23	-	-	0222-0714
	SX-F 450 07-25	0222-0705	-	-	SER 300 14-24	0222-0698	-	-
	SX-F 450 Factory Edition 13-25	0222-0705	0222-0707	-	SER 300 14-24	0222-0698	-	-
LIGHTING	SX-F 450 Herlings Replica 19	-	0222-0707	-	SUZUKI			
	SX-F 505 07-08	-	0222-0707	-	RM 65 03-05	0222-0706	-	-
	SX-F 505 08	0222-0705	-	-	RM 85 02-25	-	-	0222-0708
ENGINE	EXC 125 94-99	0222-0689	-	-	RM 100 03-04	0222-0706	-	-
	EXC 125/200/250/300/400 00-02	0222-0695	-	-	RM 125 96-99	0222-0696	-	-
	EXC 125 03-16	0222-0705	0222-0707	-	RM 250 96-00	0222-0696	-	-
FUEL/AIR SYSTEMS	EXC 150 20-25	0222-0705	0222-0707	-	RM-Z 250 04-06	0222-0696	-	-
	EXC 200 98-16	-	0222-0707	-	RM-Z 250 07-24	0222-0699	-	0222-0716
	EXC 200 03-17	0222-0705	-	-	RM-Z 450 05-24	0222-0699	-	0222-0716
HARDWARE & MERCHANDISING	EXC 200 98-99	0222-0689	-	-	RMX 450 10, 17-19	-	-	0222-0716
	EXC 250 94-99	0222-0689	-	-	RMX 450 10-19	0222-0699	-	-
	EXC 250 94-25	-	0222-0707	-	DR-Z 400 00-05	0222-0696	-	-
					DR-Z 400S 00-16	0222-0696	-	-
					YAMAHA			
					YZ 65 18-24	-	-	0222-0708
					YZ 85 02-24	-	-	0222-0708
					YZ 125 98-24	0222-0697	-	-
					YZ 250 98-24	0222-0697	-	-
					YZ 250F 01-13	0222-0697	-	-
					YZ 250F 14-24	0222-0699	-	-
					YZ 400F 98-99	0222-0697	-	-
					YZ 426F 00-02	0222-0697	-	-
					YZ 450F 03-13	0222-0697	-	-
					YZ 450F 09-24	0222-0699	-	-
					YZ 450SM 14-17	0222-0699	-	-
					WR 250F 01-19	0222-0697	-	-
					WR 250F 20-24	0222-0699	-	-
					WR 400F 98-00	0222-0697	-	-
					WR 426F 01-02	0222-0697	-	-
					WR 450F 03-18	0222-0697	-	-
					WR 450F 19-24	0222-0699	-	-

WHEEL BEARING KITS (NO SEALS)

FITS MODEL	FRONT KIT PART #	REAR KIT PART #	FITS MODEL	FRONT KIT PART #	REAR KIT PART #	FITS MODEL	FRONT KIT PART #	REAR KIT PART #
SUZUKI			YAMAHA			YAMAHA (CONT)		
RM 80 90-01	-	0215-1290	YZ 65 18-25	0215-1291	0215-1290	YZ 85 02-25	-	0215-1290
RM 85 02-25	-	0215-1290	YZ 80 93-01	0215-1289	0215-1290	YZ 85 19-25	0215-1291	-
			YZ 85 02-18	0215-1289	-	TFR 50E 06-15	0215-1289	-



WHEEL BEARING AND SEAL KIT

- Exact OEM replacement bearing and seal kits bring back the steering and braking control lost due to worn or rusted wheel bearings
- Kit includes necessary bearings and seals to completely rebuild each hub
- Double-sealed ball bearings keep moisture and contamination from entering bearing



- Seals ensure proper fitment
- For the full line of wheel bearing and seal kits see page 1009 of the 2024 Parts Europe Offroad catalog

FITS MODEL	REAR
GASGAS	
MC 85/125/250F/450F 21-25	0215-1293
EC 200 21	0215-1293
HUSABERG	
FC 450 04-05	0215-1293
FC 650 04-05	0215-1293
TE 250/300 11-14	0215-1293
FE 250/350/450/501 13-14	0215-1293
FE 390 10-11	0215-1293
FE 450 04-11	0215-1293
FE 550 07-08	0215-1293
FE 570 09-11	0215-1293
FE 650 04-08	0215-1293
HUSQVARNA	
TC 85/BW 14-25	0215-1293
TC 125/250 14-25	0215-1293
FC 250/350/450 14-25	0215-1293
TE 125 15-16	0215-1293
TE 150 17-22	0215-1293
TE 250/300 14-22	0215-1293
FE 250/450 14-20	0215-1293
FE 350/501 14-22	0215-1293
KTM	
SX 85/BW 13-25	0215-1293
SX 105 06-11	0215-1293
SX 125 93-22	0215-1293
SX 144 07-08	0215-1293
SX 150 09-22	0215-1293
SX 200 00-04	0215-1293
SX 250 94-22	0215-1293
SX 300 94	0215-1293

FITS MODEL	REAR
KTM (CONT)	
SX 360 96-97	0215-1293
SX 380 98-02	0215-1293
SX 400 98-02	0215-1293
SX 440 94	0215-1293
SX 450 03-06	0215-1293
SX 520 00-02	0215-1293
SX 525 03-06	0215-1293
SX 620 97-99	0215-1293
SX-F 250 05-25	0215-1293
SX-F 350 11-25	0215-1293
SX-F 450 07-25	0215-1293
SX-F 505 08	0215-1293
EXC 125 93-09	0215-1293
EXC 200 98-05	0215-1293
EXC 250/300 94-05	0215-1293
EXC 360 96-97	0215-1293
EXC 380 98-02	0215-1293
EXC 400 00-02	0215-1293
EXC 440 94-95	0215-1293
EXC 450 03-11	0215-1293
EXC 500 12-16	0215-1293
EXC 520 00-02	0215-1293
EXC 525 03-07	0215-1293
EXC 530 09-11	0215-1293
EXC 620 94	0215-1293
EXC-F 250 17-19	0215-1293
EXC-F 350 12-22	0215-1293
EXC-F 450 17-20	0215-1293
EXC-F 500 17-22	0215-1293
EXC-G 250 Racing 02-05	0215-1293

FITS MODEL	REAR
KTM (CONT)	
EXC-G 400 04-06	0215-1293
EXC-G 450 03-07	0215-1293
EXC-R 450/530 08	0215-1293
Freeride 250F 19	0215-1293
Freeride 250R 15-17	0215-1293
EGS 125 93-99	0215-1293
EGS 200/380 98-99	0215-1293
EGS 250/300 94-99	0215-1293
EGS 360 96-97	0215-1293
EGS 620 94	0215-1293
EXE 125 00-01	0215-1293
MXC 200 98-03	0215-1293
MXC 250 98-01	0215-1293
MXC 300 94-05	0215-1293
MXC 360 96-97	0215-1293
MXC 380 98-01	0215-1293
MXC 400/520 01-02	0215-1293
MXC 440 94	0215-1293
MXC 550 94-96	0215-1293
MXC-G 450 03-05	0215-1293
MXC-G 525 03-05	0215-1293
SXC 400 97-00	0215-1293
SXC 620 97	0215-1293
SXC 625 03-05	0215-1293
SXS 85 13-14	0215-1293
SXS 125 04	0215-1293
SXS 250 01-04	0215-1293
SXS 450 03-04	0215-1293
SXS 540 01-06	0215-1293



REAR WHEEL BEARING KITS

- Our advanced premium off-road wheel bearing kit contains all elements required for a full service of your wheel hub
- Factory-Links ball bearing features a dedicated off-road design with dust seals that offer the ultimate protection against the intrusion of contaminants such as water, mud and dust
- Our Nitrile Butadiene rubber double-lip oil seals and DINP6 - ABEC3 ball bearings have established a categorical improvement over conventional bearings
- Bearings are packed with a heavy-duty premium marine grease that features special thickeners which allows it to be virtually waterproof to provide unsurpassed rust and corrosion protection
- See pages 1004-1008 of the 2024 Parts Europe Offroad catalog for the Factory Links' full line of wheel bearing kits

FITS MODEL	PART #
GASGAS	
MC-E 5 21-25	0215-1300
MC 50 21-25	0215-1300

FITS MODEL	PART #
HUSQVARNA	
EE 5 20-25	0215-1300
TC 50 18-25	0215-1300

FITS MODEL	PART #
KTM	
SX-E 5 20-25	0215-1300
SX 50/Factory Edition 15-25	0215-1300



EXHAUST

LUGGAGE

BIKE STANDS & ACCESSORIES

HANDLEBARS & HAND CONTROLS

FOOTPEGS & FOOT CONTROLS

BODY

GRAPHICS & SEATS

SPROCKETS

CHAINS

BRAKES

WHEELS & ACCESSORIES

SUSPENSION

ELECTRICAL & GAUGES

LIGHTING

ENGINE

FUEL/AIR SYSTEMS

HARDWARE & MERCHANDISING

WHEELS & ACCESSORIES

EXHAUST

LUGGAGE

BIKE STANDS & ACCESSORIES

HANDLEBARS & HAND CONTROLS

FOOTPEGS & FOOT CONTROLS

BODY

GRAPHICS & SEATS

SPROCKETS

CHAINS

BRAKES

WHEELS & ACCESSORIES

SUSPENSION

ELECTRICAL & GAUGES

LIGHTING

ENGINE

FUEL/AIR SYSTEMS

HARDWARE & MERCHANDISING



0220-0067



0220-0068



WHEEL SPACERS

- Replace or upgrade OEM wheel spacers with these durable replacements
- Water and dirt grind between wheel bearing seals and soft OEM aluminum wheel spacers; this creates grooves and allows for bearing contamination
- Moose Racing wheel spacers feature hardened steel contact surfaces
- This makes for a tight seal that will last for years and keep your bearings fresh
- Our spacers are made from hardened steel shell, or solid - hardened and ground bearing steel, depending on application

- Upgrade to Moose Racing wheel spacers when you replace damaged wheel bearings, or before you have to
- Kits come with two spacers, unless called out in catalog
- See pages 1019-1020 of the 2024 Parts Europe Offroad catalog for the complete line of Moose Racing wheel spacers

FITS MODEL	FRONT PART #	REAR PART #
BETA		
RX 2T 300 21-23	0220-0067	0220-0068
RR Race 2T 125 21-23	0220-0067	0220-0068
RR Race 2T 200 21-23	0220-0067	0220-0068
RR Race 2T 250 22-23	0220-0067	0220-0068
RR Race 2T 300 22-23	0220-0067	0220-0068
RR Race 4T 350 22-23	0220-0067	0220-0068
RR Race 4T 390 22-23	0220-0067	0220-0068
RR Race 4T 430 22-23	0220-0067	0220-0068
RR Race 4T 480 22-23	0220-0067	0220-0068
RR 2T 125 19-23	0220-0067	0220-0068
RR 2T 200 19-23	0220-0067	0220-0068
RR 2T 250 13-23	0220-0067	0220-0068
RR 2T 300 13-23	0220-0067	0220-0068
RR 4T 350 22-23	0220-0067	0220-0068
RR 4T 390 15-23	0220-0067	0220-0068
RR 4T 400 13-14	0220-0067	0220-0068
RR 4T 430 15-23	0220-0067	0220-0068
RS 4T 390 15-23	0220-0067	0220-0068
RS 4T 400 14	0220-0067	0220-0068
RR 4T 450 13-14	0220-0067	0220-0068
RR 4T 480 18-23	0220-0067	0220-0068
RR 4T 498 13-14	0220-0067	0220-0068
RR-S 4T 350 17-23	0220-0067	0220-0068
RR-S 4T 390 17-23	0220-0067	0220-0068
RR-S 4T 430 17-23	0220-0067	0220-0068
RR-S 4T 500 17-23	0220-0067	0220-0068
Xtrainer 300 15-23	0220-0066	0220-0068
GASGAS		
MC 125 23-24	-	0220-0065
MC 250 24	-	0220-0065
MC 250F 24	-	0220-0065
MC 250F Factory Edition 23-24	-	0220-0065
MC 450F 24	-	0220-0065
MC 450F Factory Edition 23-24	-	0220-0065
EC 450F 24	-	0220-0065

FITS MODEL	FRONT PART #	REAR PART #
GASGAS (CONT)		
EW 500F 24	-	0220-0065
HUSQVARNA		
TC 125 23-24	-	0220-0065
TC 125 Heritage 23	-	0220-0065
TC 250 23-24	-	0220-0065
TC 250 Heritage 23	-	0220-0065
FC 250 23-24	-	0220-0065
FC 250 Heritage 23	-	0220-0065
FC 250 Rockstar Edition 24	-	0220-0065
FC 350 23-24	-	0220-0065
FC 350 Heritage 23	-	0220-0065
FC 450 23-24	-	0220-0065
FC 450 Heritage 23	-	0220-0065
FC 450 Rockstar Edition 22-24	-	0220-0065
TE 150 24	-	0220-0065
TE 250 24	-	0220-0065
TE 300 24	-	0220-0065
FE 450 24	-	0220-0065
KTM		
SX 125 23-24	-	0220-0065
SX 250 23-24	-	0220-0065
SX 300 23-24	-	0220-0065
SX-F 250 23-24	-	0220-0065
SX-F 250 Factory Edition 24	-	0220-0065
SX-F 350 23-24	-	0220-0065
SX-F 450/Factory Edition 22-24	-	0220-0065
EXC 125 23-24	-	0220-0065
EXC 250 23-24	-	0220-0065
EXC 300 23-24	-	0220-0065
EXC 300 Erzbergrodeo/Hardenduro/Six Days 24	-	0220-0065
EXC-F 250 23-24	-	0220-0065
EXC-F 350 24	-	0220-0065
EXC-F 350/Factory Edition 23-24	-	0220-0065
EXC-F 450 23-24	-	0220-0065
EXC-F 500/Six Days 24	-	0220-0065



REAR WHEEL SPACER

- Anodized spacers are lighter and more durable than OEM
- Sold in pairs for left and right side of one axle
- Available in black
- For the full line of wheel spacers see page 1022 of the 2024 Parts Europe Offroad catalog

FITS MODEL	PART #	FITS MODEL	PART #	FITS MODEL	PART #
GASGAS		HUSQVARNA		KTM	
MC 125/250 24-25	0222-0685	TC 125/250 23-25	0222-0685	SX 125/250/300 23-25	0222-0685
MC 150/3500 25	0222-0685	TC 150/300 25	0222-0685	SX 150 25	0222-0685
MC 250F/350F/450F 24-25	0222-0685	FC 250/350/450 23-24	0222-0685	SX-F 250/350/450 23-25	0222-0685
EC 125 25	0222-0685	TE 125 25	0222-0685	EXC 150/250/300 24-25	0222-0685
EC 250F/350F/450F/500F 24-25	0222-0685	FE 250/350 24	0222-0685		
		FE 450/501 24-25	0222-0685		



AXLE PULLS

- Makes wheel removal and installation faster and easier
- Takes only seconds to mount
- Durable billet aluminum construction with black anodized finish
- Handle and split-bevel design allows the user to simply pull axle out
- See page 1023 of the 2024 Parts Europe Offroad catalog for the complete line of SCAR axle pulls



EXHAUST

LUGGAGE

BIKE STANDS & ACCESSORIES

HANDLEBARS & HAND CONTROLS

FOOTPEGS & FOOT CONTROLS

BODY

GRAPHICS & SEATS

SPROCKETS

CHAINS

BRAKES

WHEELS & ACCESSORIES

SUSPENSION

ELECTRICAL & GAUGES

LIGHTING

ENGINE

FUEL/AIR SYSTEMS

HARDWARE & MERCHANDISING

REAR AXLE PULLS

FITS MODEL	PART #
GASGAS	
MC 125/250 24-25, MC 150/300 25	3811-0154
HUSQVARNA	
TC 125/250 23-25, TC 150/300 25, FC 250/350/450 23-25, TE 125 25, TE 150/250/300 24-25, FE 250/350/450/501 24-25	3811-0154

FITS MODEL	PART #
KTM	
SX 125/250/300 23-25, SX 150 25, SX-F 250/350/450 23-25, EXC 125/250/300 24-25, EXC-F 250/350/450/500 24-25	3811-0154



RIM TAPE

- 7 mm wide rim transfers for motorcycle and scooters rims give a great visual boost
- It can also serve as a separation between different colors on bodywork panels or to accentuate specific contours
- Includes one 6 m roll of rim tape
- Sufficient for two rims up to 45,72 cm



COLOR	PART #	COLOR	PART #	COLOR	PART #	COLOR	PART #	COLOR	PART #
Black	4301-1061	Green	4301-1063	Neon orange	4301-1065	Pink	4301-1067	White	4301-1069
Blue	4301-1062	Lime green	4301-1064	Neon yellow	4301-1066	Red	4301-1068		



UNIVERSAL 50 cc TRAINING WHEELS

- Works on any 50 cc motorcycle
- Adjustable for terrain and riders' skill level
- Solid steel axle with CNC machined components for accurate fit
- 20,5 cm (8") pneumatic wheels with 4-ply tires
- Sealed ball bearings
- Hardened fasteners

WARNING: FAILURE TO USE THE APPARATUS CORRECTLY CAN RESULT IN SERIOUS INJURY OR DEATH. ONLY USE THESE TRAINING WHEELS FOR THE INTENDED TRAINING PURPOSE. THIS IS ONLY A TRAINING AID!!!!



DESCRIPTION	PART #
Universal training wheels	9501-0293



EXHAUST

LUGGAGE

BIKE STANDS & ACCESSORIES

HANDLEBARS & HAND CONTROLS

FOOTPEGS & FOOT CONTROLS

BODY

GRAPHICS & SEATS

SPROCKETS

CHAINS

BRAKES

WHEELS & ACCESSORIES

SUSPENSION

ELECTRICAL & GAUGES

LIGHTING

ENGINE

FUEL/AIR SYSTEMS

HARDWARE & MERCHANDISING



S46 OFFROAD SHOCK

- STX-technology
- Great dynamics equal optimum function
- Rebound adjuster
- Wide range of low speed compression adjustment, 3 clicks high speed adjustment
- Comes equipped with our Position Damping System (PDS)
- Full maintenance and service capability

FITS MODEL	PART #	FITS MODEL	PART #	FITS MODEL	PART #
GASGAS		HUSQVARNA		KTM	
MC 85 21-24	1310-2456	TC 85 17/14, 19/16 BW 18-24	1310-2456	SX 85 17/14, 19/16 BW 18-24	1310-2456



STX 22 CARTRIDGES

- STX-technology
- Low profile top cap design making it possible to move the fork tubes far up the triple clamps
- Efficient hydraulic stop for improved bottoming resistance
- Adjustable compression and rebound
- Spring pressurized system to compensate for heat changes and provide reliable damping behavior
- Converts air forks to spring type forks for better reliability and constant performance
- Full maintenance and service capabilities

FITS MODEL	PART #	FITS MODEL	PART #	FITS MODEL	PART #
GASGAS		HUSQVARNA		KTM	
MC 85 21-24	0413-0164	TC 85 17/14, 19/16 BW 18-24	0413-0164	SX 85 17/14, 19/16 BW 18-24	0413-0164



RXF 48 FRONT FORKS

- 48 mm front forks fully loaded with the TTX 22 cartridge kits inside and the latest Öhlins front fork technology
- Main piston performance in the cartridge kit is improved thanks to the springs fitted to the kit; inner tubes feature a titanium oxide treatment
- Check valve unit helps the forks stay up in stroke without feeling too hard, which also improves the overall performance
- Hard enough to resist stones but is still solid enough to prevent corrosion
- Come with protective stickers for the outer tube to protect the outer tube all way up to the lower clamp

FITS MODEL	PART #	FITS MODEL	PART #	FITS MODEL	PART #
GASGAS		HUSQVARNA (CONT)		KTM (CONT)	
MC 125 21-25	0402-0005	TC 300 25	0402-0003	SX 300 23-25	0402-0005
MC 150 25	0402-0003	FC 250 16-25	0402-0005	SX-F 250 16-25	0402-0005
MC 250 22-25	0402-0003	FC 350 16-25	0402-0003	SX-F 350 16-25	0402-0003
MC 300 25	0402-0003	FC 450 16-25	0402-0004	SX-F 450 16-25	0402-0003
MC 250F 21-25	0402-0003	TE 150 24	0402-0003	EXC 150 24	0402-0005
MC 350F 22-25	0402-0003	TE 250 24	0402-0003	EXC 250/Six Days 24	0402-0005
MC 450F 21-25	0402-0003	TE 300 24	0402-0003	EXC 300 24	0402-0005
HONDA		FE 250 24	0402-0005	EXC 300 Hardenduro 24	0402-0003
CRF 250R 18-24	0402-0004	FE 350 24	0402-0005	EXC 300/Six Days 24	0402-0005
CRF 450R 17-24	0402-0004	FE 450 24	0402-0005	EXC-F 250/Six Days 24	0402-0005
HUSQVARNA		FE 501 24	0402-0005	EXC-F 350/Six Days 24	0402-0005
TC 125 16-25	0402-0005	KTM		EXC-F 450/Six Days 24	0402-0005
TC 150 25	0402-0003	SX 125 16-25	0402-0005	EXC-F 500/Six Days 24	0402-0005
TC 250 16-25	0402-0003	SX 250 16-25	0402-0003		



EXHAUST

LUGGAGE

BIKE STANDS & ACCESSORIES

HANDLEBARS & HAND CONTROLS

FOOTPEGS & FOOT CONTROLS

BODY

GRAPHICS & SEATS

SPROCKETS

CHAINS

BRAKES

WHEELS & ACCESSORIES

SUSPENSION

ELECTRICAL & GAUGES

LIGHTING

ENGINE

FUEL/AIR SYSTEMS

HARDWARE & MERCHANDISING

TTX 22 CARTRIDGE KITS

- Cartridge kits with patented TTX design
- Gas pressurized damping system for immediate damping response
- Easy installation in OE front forks
- External compression and rebound adjusters
- Improved hydraulic stops to improve bottoming resistance
- Springs, oil and installation tools sold separately
- New top out rubber for smoother top out feeling
- Available for all major MX and Enduro models

DESCRIPTION	PART #
GASGAS	
MC 125 21-24	0413-0167
MC 250 22-24	0413-0167
MC 250F 21-24	0413-0167
MC 350F 22-24	0413-0167
MC 450F 21-24	0413-0167
EC 250 21-23	0413-0169
EC 300 21-23	0413-0169
EC 250F 21-23	0413-0169
EC 350F 21-23	0413-0169
HONDA	
CRF 250R 18-24	0413-0165
CRF 450R 17-24	0413-0165
HUSQVARNA	
TC 125 21-24	0413-0168
TC 250 21-24	0413-0168
FC 250 21-24	0413-0168
FC 350 21-24	0413-0168
FC 450 21-24	0413-0168
TE 150 19-23	0413-0169
TE 150 24	0413-0170
TE 250 19-23	0413-0169
TE 250 24	0413-0170

DESCRIPTION	PART #
HUSQVARNA (CONT)	
TE 300 19-23	0413-0169
TE 300 24	0413-0170
FE 250 19-23	0413-0169
FE 250 24	0413-0170
FE 350 19-23	0413-0169
FE 350 24	0413-0170
FE 450 19-23	0413-0169
FE 450 24	0413-0170
FE 501 19-23	0413-0169
FE 501 24	0413-0170
KAWASAKI	
KX 250 20-24	0413-0166
KX 450 19-24	0413-0165
KTM	
SX 125 21-24	0413-0167
SX 250 21-24	0413-0167
SX 300 23-24	0413-0167
SX-F 250 21-24	0413-0167
SX-F 350 21-24	0413-0167
SX-F 450 21-24	0413-0167
EXC 150 19-23	0413-0169
EXC 150 24	0413-0170

DESCRIPTION	PART #
KTM (CONT)	
EXC 250/Six Days 19-23	0413-0169
EXC 250/ Six Days 24	0413-0170
EXC 300/Six Days/Erzberggradeo 19-23	0413-0169
EXC 300/Six Days/Hardenduro 24	0413-0170
EXC-F 250/Six Days 19-23	0413-0169
EXC-F 250/Six Days 24	0413-0170
EXC-F 350/Six Days 19-23	0413-0169
EXC-F 350 Six Days 24	0413-0170
EXC-F 450/Six Days 19-23	0413-0169
EXC-F 450/Six Days 24	0413-0170
EXC-F 500/Six Days 19-23	0413-0169
EXC-F 500/Six Days 24	0413-0170
SUZUKI	
RM-Z 250 19-24	0413-0166
RM-Z 450 18-24	0413-0165
YAMAHA	
YZ 250F 14-23	0413-0166
YZ 450F 14-24	0413-0166

FRONT FORK SPRINGS

- Race-developed and tested in World Superbike, World Supersport and AMA Superbike competition
- For use with OEM fork tubes
- Sold in pairs

DESCRIPTION	PART #
FOR CARTRIDGE KIT PART #S 0413-0166, 0413-0167, 0413-0168, 0413-0169 & 0413-0170	
43,6/467/4,1	0405-1330
43,6/467/4,3	0405-1331
43,6/467/4,5	0405-1332
43,6/467/4,7	0405-1333
43,6/467/4,9	0405-1334
43,6/467/5,1	0405-1335

DESCRIPTION	PART #
FOR CARTRIDGE KIT PART #0413-0164	
38,2/423/3,0	0405-1336
38,2/423/3,2	0405-1337
38,2/423/3,4	0405-1338
38,2/423/3,6	0405-1339
38,2/423/3,8	0405-1340
44,6/471/4,3	0405-1341

DESCRIPTION	PART #
FOR CARTRIDGE KIT PART #0413-0165	
44,6/471/4,3	0405-1342
44,6/471/4,5	0405-1343
44,6/471/4,7	0405-1344
44,6/471/4,9	0405-1345
44,6/471/5,1	0405-1346



EXHAUST

LUGGAGE

BIKE STANDS & ACCESSORIES

HANDLEBARS & HAND CONTROLS

FOOTPEGS & FOOT CONTROLS

BODY

GRAPHICS & SEATS

SPROCKETS

CHAINS

BRAKES

WHEELS & ACCESSORIES

SUSPENSION

ELECTRICAL & GAUGES

LIGHTING

ENGINE

FUEL/AIR SYSTEMS

HARDWARE & MERCHANDISING



FORK SPRINGS

- Available in multiple rates to help you dial in the front suspension
- Recommended fork oil viscosity and oil fill height (mm, measured from top of the fork tube, collapsed, with spring removed) or fork oil volume (cc) listed in chart (where applicable)
- See pages 1038 to 1040 of the 2024 Parts Europe Offroad catalog for additional front fork spring kits



FITS MODEL	SPRING RATE	PART #	RECOMMENDED FORK OIL VISCOSITY	RECOMMENDED FORK OIL VOLUME (CC)	
KAWASAKI					
KX 250 19-24	3,8 N/mm	0405-1322	SAE 5	340 cc	
	4,0 N/mm	0405-1323	SAE 5	340 cc	
	4,2 N/mm	0405-1324	SAE 5	340 cc	
	4,5 N/mm	0405-1325	SAE 5	340 cc	
	4,8 N/mm	0405-1326	SAE 5	340 cc	
	5,1 N/mm	0405-1327	SAE 5	340 cc	
SUZUKI	5,4 N/mm	0405-1328	SAE 5	340 cc	
	RM-Z 250 18-23				
	3,8 N/mm	0405-1322	SAE 5	340 cc	
	4,0 N/mm	0405-1323	SAE 5	340 cc	
	4,2 N/mm	0405-1324	SAE 5	340 cc	
4,5 N/mm	0405-1325	SAE 5	340 cc		
4,8 N/mm	0405-1326	SAE 5	340 cc		
5,1 N/mm	0405-1327	SAE 5	340 cc		
5,4 N/mm	0405-1328	SAE 5	340 cc		
YAMAHA					
YZ 125 22-23	3,8 N/mm	0405-1322	SAE 5	350 cc	
	4,0 N/mm	0405-1323	SAE 5	350 cc	
	4,2 N/mm	0405-1324	SAE 5	350 cc	

FITS MODEL	SPRING RATE	PART #	RECOMMENDED FORK OIL VISCOSITY	RECOMMENDED FORK OIL VOLUME (CC)
YAMAHA (CONT)				
YZ 125 22-23 (CONT)	4,5 N/mm	0405-1325	SAE 5	350 cc
	4,8 N/mm	0405-1326	SAE 5	350 cc
	5,1 N/mm	0405-1327	SAE 5	350 cc
	5,4 N/mm	0405-1328	SAE 5	350 cc
YZ 250 22-23	3,8 N/mm	0405-1322	SAE 5	350 cc
	4,0 N/mm	0405-1323	SAE 5	350 cc
	4,2 N/mm	0405-1324	SAE 5	350 cc
	4,5 N/mm	0405-1325	SAE 5	350 cc
	4,8 N/mm	0405-1326	SAE 5	350 cc
	5,1 N/mm	0405-1327	SAE 5	350 cc
WR 450F 17-23	5,4 N/mm	0405-1328	SAE 5	350 cc
	3,8 N/mm	0405-1322	SAE 5	340 cc
	4,0 N/mm	0405-1323	SAE 5	340 cc
	4,2 N/mm	0405-1324	SAE 5	340 cc
WR 450F 17-23	4,5 N/mm	0405-1325	SAE 5	340 cc
	4,8 N/mm	0405-1326	SAE 5	340 cc
	5,1 N/mm	0405-1327	SAE 5	340 cc
	5,4 N/mm	0405-1328	SAE 5	340 cc
	3,8 N/mm	0405-1322	SAE 5	340 cc
	4,0 N/mm	0405-1323	SAE 5	340 cc

COMPRESSION ADJUSTER KIT FOR KYB AOS FORKS

- Designed to fit motorcycles 06-Present fitted with KYB AOS/SSS forks
- Allows for easy adjustments to compression damping without the use of tools
- Includes Motion Pro Micro Bleeder Set PART #0404-0280 to allow for tool-free fork bleeding
- Anodized billet 6061 aluminum construction with stainless steel adjuster knob
- Requires 10 mm handlebar clearance above top of fork cap
- Kit includes complete set to fit both fork legs



DESCRIPTION	PART #
Compression adjuster kit for KYB AOS forks	3801-0421



FRONT FORK SPRING COLLARS

- Include guide bush and spring seat
- See page 1054 of the 2024 Parts Europe Offroad catalog for the complete line of KYB front fork spring collars



FITS MODEL	PART #	FITS MODEL	PART #	FITS MODEL	PART #
BETA		HONDA		SUZUKI	
RX 300 23-24, RX 450 24	0450-0683	CRF 450R 12	0450-0683	RM-Z 250 19-24	0450-0683
RR 2T 125/200/250/300 20-24	0450-0683	KAWASAKI		YAMAHA	
RR 4T 350/390/430/480 20-24	0450-0683	KX 250 20-24	0450-0682	YZ 125/250 15-24	0450-0683
FANTIC		KX 450F 11-12	0450-0683	YZ 250F 15-18	0450-0683
XX 125 21-24	0450-0683	RIEJU		YZ 250F 19-25	0450-0682
XX 250 21-23	0450-0683	MR PRO 250/300 21	0450-0683	YZ 450F 15-19	0450-0683
XXF 250/450 21-24	0450-0682	MR RACING 250/300 21	0450-0683	YZ 450F 20-25	0450-0682
XE 125 22-24	0450-0683	SHERCO		WR 250F 15-19	0450-0683
XE 300 24	0450-0683	SE-R 125/250/300 19-24	0450-0683	WR 250F 20-25	0450-0682
XF 250/450 21-24	0450-0682	SEF-R 250/300/450/500 19-24	0450-0683	WR 450F 12-18	0450-0683
GASGAS		STARK		WR 450F 19-25	0450-0682
EC 250/300 18-20	0450-0683	Varg 23-24	0450-0683		



EXHAUST

LUGGAGE

BIKE STANDS & ACCESSORIES

HANDLEBARS & HAND CONTROLS

FOOTPEGS & FOOT CONTROLS

BODY

GRAPHICS & SEATS

SPROCKETS

CHAINS

BRAKES

WHEELS & ACCESSORIES

SUSPENSION

ELECTRICAL & GAUGES

LIGHTING

ENGINE

FUEL/AIR SYSTEMS

HARDWARE & MERCHANDISING

FORK REBOUND BASE VALVES

• See page 1052 of the 2024 Parts Europe Offroad catalog for the complete line of KYB fork rebound base valves

FITS MODEL	PART #
FANTIC	
XX 125/250 21-23	1314-0804
XE 125 21-24, XE 300 24	1314-0804
GASGAS	
EC 250/300 18-20	1314-0804

FITS MODEL	PART #
RIEJU	
MR PRO 250/300 21	1314-0804
MR RACING 250/300 21	1314-0804
YAMAHA	
YZ 125/250 15-21	1314-0804
WR 250F 15-19	1314-0804
WR 450F 15-18	1314-0804



FRONT FORK REBOUND ADJUSTER

• See page 1053 of the 2024 Parts Europe Offroad catalog for the complete line of KYB front fork rebound adjuster

FITS MODEL	PART #
BETA	
RX 300 23-24, RX 450 24	0450-0684
RR 2T 125/200/250/300 20-24	0450-0684
RR 4T 350/390/430/480 20-24	0450-0684
FANTIC	
XX 125/250 21-24	0450-0684
XXF 250/450 21-24	0450-0684
XE 125 21-24	0450-0684
XF 250/450 21-24	0450-0684
GASGAS	
EC 250/300 18-20	0450-0684
HONDA	
CRF 450R 13-14	0450-0684
KAWASAKI	
KX 250 20-24	0450-0684
KX 450F 13-14	0450-0684
RIEJU	
MR PRO 250/300 21-24	0450-0684
MR RACING 250/300 21-24	0450-0684

FITS MODEL	PART #
SHERCO	
SE-R 125/250/300 19-24	0450-0684
SEF-R 250/300/450/500 19-24	0450-0684
STARK	
Varg (all) 23-24	0450-0684
SUZUKI	
RM-Z 250 19-24	0450-0684
TM	
MX 125/250 13-24, MX 250/450 Fi 13-24	0450-0684
YAMAHA	
YZ 125/250 15-24	0450-0684
YZ 250F 15-24	0450-0684
YZ 450F 15-24	0450-0684
WR 250F 15-24	0450-0684
WR 450F 15-24	0450-0684



FRONT FORK CYLINDER HEAD BUSHING

FITS MODEL	PART #
BETA	
RR 2T 125/250/300 20-24	0413-0050
RR 4T 350/390/430/480 20-24	0413-0050
FANTIC	
XX 125/250 20-24	0413-0050
XXF 250/450 20-24	0413-0050
XE 125 20-24	0413-0050
XF 250/450 20-24	0413-0050
GASGAS	
EC 250/300 18-20	0413-0050
HONDA	
CR 125R 95-07	0413-0050
CR 250R 95-96	0413-0050
CR 500R 95-02	0413-0050
CRF 450R 09-16	0413-0050

FITS MODEL	PART #
KAWASAKI	
KX 125/250 95-08	0413-0050
KX 500 91-94	0413-0050
KX 250F 04-05, KX 250 20-24	0413-0050
KX 450F 06-14	0413-0050
RIEJU	
MR PRO 250/300 21-24	0413-0050
MR RACING 250/300 21-24	0413-0050
SHERCO	
SE-R 125/250/300 19-24	0413-0050
SEF-R 250/300/450/500 19-24	0413-0050
STARK	
Varg (all) 23	0413-0050
SUZUKI	
RM 250 01-03	0413-0050
RM-Z 250 04-06/16-24	0413-0050

FITS MODEL	PART #
TM	
MX 125/250 13-24, MX 250/450 Fi 13-24	0413-0050
YAMAHA	
YZ 80 93-01	0413-0050
YZ 85 02-16	0413-0050
YZ 125/250 95-24	0413-0050
YZ 250F 01-24	0413-0050
YZ 400F 99	0413-0050
YZ 426F 00-02	0413-0050
YZ 450F 03-24	0413-0050
WR 250F 01-24	0413-0050
WR 400F 98-00	0413-0050
WR 426F 01-02	0413-0050
WR 450F 03-24	0413-0050

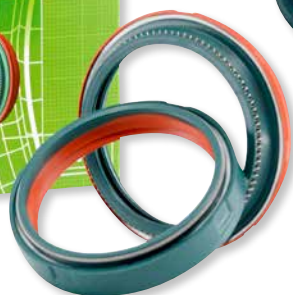

0407-0915

0407-0900

FRONT FORK SEALS

- High quality replacement fork seals
- Most performance models available in "NOK" anti-stiction material
- Dual compound seals have a green tough durable part that maintains a high surface grip without compromising friction and a red soft and flexible part that adapts to any micro-imperfections of the fork tube
- Sold in pairs
- See pages 1081-1083 of the 2024 Parts Europe Offroad catalog for the full line of Athena Front Fork Seals

FITS MODEL	STANDARD KIT PART #	DUAL COMPOUND PART #
BETA		
RR Racing 2T 125 18-24	0407-0897	0407-0915
	0407-0898 ¹	-
RR Racing 2T 250/300 13-14	0407-0900	-
RR Racing 2T 250/300 15-19	0407-0905	0407-0917
	0407-0906 ¹	-
RR Racing 2T 250 20-24	0407-0897	0407-0915
	0407-0898 ¹	-
RR 4T Racing 350/430/480 15-19	0407-0905	0407-0918
	0407-0906 ¹	-
RR 4T Racing 350/430/480 20-24	0407-0897	0407-0915
	0407-0898 ¹	-
RR 2T 125 18-24	0407-0905	0407-0915
	0407-0906 ¹	0407-0918
RR 2T 250/300 13-14	0407-0900	-
RR 2T 250/300 15-24	0407-0905	0407-0918
	0407-0906 ¹	-
RR 4T 350/400/498 12-14	0407-0900	-
RR 4T 350/390/430/480 15-24	0407-0905	0407-0918
	0407-0906 ¹	-
RR 4T 400/450 05-10	0407-0890	-
	0407-0891 ¹	-
RR 4T 400/450 2011	0407-0909	-
	0407-0910 ¹	-
RR 4T 450 12-14	0407-0900	-
RR 4T 520 10	0407-0890	-
	0407-0891 ¹	-
RR 4T 525 05-09	0407-0890	-
	0407-0891 ¹	-
Xtrainer 300 15-19	0407-0884	-
Evo 125/250/300 2T Factory 12-24	0407-0878	-
Evo 200 2T 12-24	0407-0878	-
Evo 300 2T 06-24	0407-0878	-
Evo 300 2T SS 17-24	0407-0878	-
Evo 250/300 4T 12-24	0407-0878	-
Evo 300 4T Factory 17-24	0407-0878	-
Minicross 10/12/15 05	0407-0873	-
COBRA		
CX Jr/Sr 50 18-23	0407-0872	-
FANTIC		
XX 125/250 20-24	0407-0897	0407-0915
	0407-0898 ¹	-
XXF 250 22-24	0407-0897	0407-0915
	0407-0898 ¹	-
XXF 450 23-24	0407-0897	0407-0915
	0407-0898 ¹	-
XE 125 20-24	0407-0897	0407-0915
	0407-0898 ¹	-
XEF 250/450 22-24	0407-0897	0407-0915
	0407-0898 ¹	-
GASGAS		
MC 50/65 21-24	0407-0875	-
MC 85 21-24	0407-0888	0407-0912
MC 125 04-09	0407-0890	-
	0407-0891 ¹	-
MC 125 21-24	0407-0903	0407-0917
	0407-0904 ¹	-

FITS MODEL	STANDARD KIT PART #	DUAL COMPOUND PART #
GASGAS (CONT)		
MC 250 22-24	0407-0903	0407-0917
	0407-0904 ¹	-
MC 250F 21-24	0407-0903	0407-0917
	0407-0904 ¹	-
MC 350F 24	0407-0903	0407-0917
	0407-0904 ¹	-
MC 450F 21-24	0407-0903	0407-0917
	0407-0904 ¹	-
EC 125 04-10	0407-0890	-
	0407-0891 ¹	-
EC 125 Race 09-15	0407-0890	-
	0407-0891 ¹	-
EC 200 04-10	0407-0890	-
	0407-0891 ¹	-
EC 200/250 11-15	0407-0900	-
	0407-0891 ¹	-
EC 200 19	0407-0897	0407-0915
	0407-0898 ¹	-
EC 250 04-13	0407-0890	-
EC 250/300 GP 18-19	0407-0897	0407-0915
	0407-0898 ¹	-
EC 250/350 21-24	0407-0903	0407-0917
	0407-0904 ¹	-
EC 300 03-13	0407-0890	-
	0407-0891 ¹	-
EC 300E 21-24	0407-0903	0407-0917
	0407-0904 ¹	-
EC 450F/500F 24	0407-0903	0407-0917
	0407-0904 ¹	-
EC 450FSE 03-07	0407-0890	-
	0407-0891 ¹	-
EC 450FSR 08-09	0407-0890	-
	0407-0891 ¹	-
TXT 125GP 18-22	0407-0880	-
TXT 250GP 18-24	0407-0880	-
TXT 280GP 18-22	0407-0880	-
TXT 125/250/280/300/Pro 06-14	0407-0881	-
TXT 250/280/300 Pro Racing 06-14	0407-0881	-
TXT 125/250/280/300 Racing 18-24	0407-0880	-
HONDA		
CR 80R 96-02	0407-0877	-
CR 85R 03-07	0407-0877	-
CR 125R 87, 92-93	0407-0887	0407-0911
CR 125R 90-91	0407-0892	0407-0913
CR 125R 94-96	0407-0884	-
CR 125R 97-08	0407-0893	0407-0914
CR 250R 81	0407-0882	-
CR 250R 85-87, 92-94	0407-0887	0407-0911
CR 250R 89-91	0407-0892	0407-0913
CR 250R 95	0407-0884	-
CR 250R 96	0407-0893	0407-0914
CR 250R 97-08	0407-0895	-
	0407-0896 ¹	-
CR 500R 84-88	0407-0887	0407-0911
CR 500R 89-91	0407-0892	-

¹ Heavy duty.



FRONT FORK SEALS (CONT)

FITS MODEL	STANDARD KIT PART #	DUAL COMPOUND PART #
HONDA (CONT)		
CR 500R 95	0407-0884	-
CR 500R 96-01	0407-0893 ²	-
CR 500R 97-01	0407-0895 ²	-
	0407-0896 ^{1,2}	-
CRF 150R 07-24	0407-0877	-
CRF 150RB 07-24	0407-0877	-
CRF 230F 03-19	0407-0877	-
CRF 230L 08-20	0407-0877	-
CRF 250L 17-20	0407-0887	0407-0911
CRF 250R 04-09	0407-0895	-
	0407-0896 ¹	-
CRF 250R 10-14	0407-0901	0407-0916
	0407-0902 ¹	-
CRF 250R 15-24	0407-0907	0407-0919
	0407-0908 ¹	-
CRF 250 Rally 17-20	0407-0887	0407-0911
CRF 300L 22-23	0407-0887	0407-0911
CRF 450L/RWE 19-24	0407-0907	0407-0919
	0407-0908 ¹	-
CRF 450R 02-08	0407-0895	-
	0407-0896 ¹	-
CFR 450R 09-12	0407-0897	0407-0915
	0407-0898 ¹	-
CRF 450R 13-16	0407-0899	-
CRF 450R 17-24	0407-0907	0407-0919
	0407-0908 ¹	-
HUSABERG		
FC 400/550 00-01	0407-0888	0407-0912
FC 470 00-01	0407-0888	0407-0912
TE 125/250/300 13-14	0407-0903	0407-0917
	0407-0904 ¹	-
FE 390 21-24	0407-0903	0407-0917
	0407-0904 ¹	-
FE 400E/400S/501/650E 00-01	0407-0888	0407-0912
FE 450 04-12	0407-0903	0407-0917
	0407-0904 ¹	-
FE 550 04-08	0407-0903	0407-0917
	0407-0904 ¹	-
FE 570 04-10	0407-0903	0407-0917
	0407-0904 ¹	-
FE 650E 04-08	-	0407-0917
HUSQVARNA		
TC 50/65 17-24	0407-0875	-
TC 85 14-24	0407-0888	0407-0912
TC 125/250 14-24	0407-0903	0407-0917
	0407-0904 ¹	-
TC 250/450 06-09	0407-0909	-
	0407-0910 ¹	-
TC 250 10-13	0407-0897	0407-0915
	0407-0898 ¹	-
TC 450 03-05	0407-0890	-
	0407-0891 ¹	-
TC 450 11-13	0407-0897	0407-0915
	0407-0898 ¹	-
TC 510 05	0407-0890	-
	0407-0891 ¹	-
TC 510 10	0407-0897	0407-0915
	0407-0898 ¹	-
TC 570 01-02	0407-0890	-
	0407-0891 ¹	-
TC 610 99-01	0407-0890	-
	0407-0891 ¹	-
FC 250/350/450 14-24	0407-0903	0407-0917
	0407-0904 ¹	-
TE 125 14-17	0407-0903	0407-0917
	0407-0904 ¹	-
TE 250 03-06	0407-0890	-
	0407-0891 ¹	-
TE 250 07-09	0407-0909	-
	0407-0910 ¹	-
TE 250/310 10-13	0407-0897	0407-0915
	0407-0898 ¹	-
TE 250/300 14-24	0407-0903	0407-0917
	0407-0904 ¹	-
TE 400 01	0407-0890	-
	0407-0891 ¹	-

FITS MODEL	STANDARD KIT PART #	DUAL COMPOUND PART #
HUSQVARNA (CONT)		
TE 410 96-01	0407-0890	-
	0407-0891 ¹	-
TE 410 10-13	0407-0897	-
	0407-0898 ¹	-
TE 450 03-05	0407-0890	-
	0407-0891 ¹	-
TE 450/510 06-09	0407-0909	-
	0407-0910 ¹	-
TE 450 10-13	0407-0897	0407-0915
	0407-0898 ¹	-
TE 510 04-05	0407-0890	-
	0407-0891 ¹	-
TE 511 11-13	0407-0897	0407-0915
	0407-0898 ¹	-
TE 570 01-04	0407-0890	-
	0407-0891 ¹	-
TE 610 99-08	0407-0890	-
	0407-0891 ¹	-
TE 630 10-11	0407-0890	-
	0407-0891 ¹	-
FE 250/350/450/501 14-24	0407-0903	0407-0917
	0407-0904 ¹	-
CR 125 07-09	0407-0909	-
	0407-0910 ¹	-
CR 125 96-06	0407-0890	-
	0407-0891 ¹	-
CR 125 10-13	0407-0897	0407-0915
	0407-0898 ¹	-
CR 150 11-13	0407-0897	0407-0915
	0407-0898 ¹	-
CR 250 96-04	0407-0890	-
	0407-0891 ¹	-
WR 125 96-08	0407-0890	-
	0407-0891 ¹	-
WR 125/250/300 07-10	0407-0909	-
	0407-0910 ¹	-
WR 125/300 11-13	0407-0897	0407-0915
	0407-0898 ¹	-
WR 250 99-08	0407-0890	-
	0407-0891 ¹	-
WR 250 10-13	0407-0897	0407-0915
	0407-0898 ¹	-
WR 360 96-02	0407-0890	-
	0407-0891 ¹	-
KAWASAKI		
KX 80 92-01	0407-0876	-
KX 85 02-24	0407-0876	-
KX 100 95-21	0407-0876	-
KX 112 22-24	0407-0876	-
	0407-0898 ¹	-
KX 125/250 91-95	0407-0884	-
KX 125/250 96-01	0407-0893	0407-0914
KX 125/250 02-08	0407-0897	0407-0915
KX 250 20-24	0407-0897	0407-0915
	0407-0898 ¹	-
KX 500 91-96	0407-0884	-
KX 500 97-04	0407-0893	0407-0914
KX 250F 04-05	0407-0897	0407-0915
	0407-0898 ¹	-
KX 250F 04-12	0407-0895	-
	-	-
KX 250F 13-19	0407-0901	0407-0915
	0407-0902 ¹	-
KDX 125SR 90-99	0407-0883	-
KDX 200 95-05	0407-0884	-
KDX 220/SR 97-05	0407-0884	-
KDX 250 91-94	0407-0893	0407-0914
KDX 250SR 91-05	0407-0884	-
KTM		
SX 50 LC/65 12-16	0407-0874	-
SX 50 LC/65 17-24	0407-0875	-
SX 65 02-11	0407-0873	-
SX 85 03-24	0407-0888	0407-0912
SX 105 06-11	0407-0888	0407-0912

¹ Heavy duty.

² Check size before ordering.

FRONT FORK SEALS continued on next page.

EXHAUST

LUGGAGE

BIKE STANDS & ACCESSORIES

HANDLEBARS & HAND CONTROLS

FOOTPEGS & FOOT CONTROLS

BODY

GRAPHICS & SEATS

SPROCKETS

CHAINS

BRAKES

WHEELS & ACCESSORIES

SUSPENSION

ELECTRICAL & GAUGES

LIGHTING

ENGINE

FUEL/AIR SYSTEMS

HARDWARE & MERCHANDISING



FRONT FORK SEALS (CONT)

	FITS MODEL	STANDARD KIT PART #	DUAL COMPOUND PART #	FITS MODEL	STANDARD KIT PART #	DUAL COMPOUND PART #
EXHAUST	KTM (CONT)			SCORPA (CONT)		
LUGGAGE	SX 125 96-98	0407-0890	-	Twenty 125/250 16	0407-0881	-
		0407-0891 ¹	-	Twenty 125/250/300 15-17	0407-0880	-
	SX 125 00-02	0407-0888	0407-0912	TV-S F Trial 125 12-16	0407-0881	-
BIKE STANDS & ACCESSORIES	SX 125/250 03-24	0407-0903	0407-0917	SHERCO		
		0407-0904 ¹	-	SE Factory 250/300 19-24	0407-0897	0407-0915
	SX 150 08-24	0407-0903	0407-0917		0407-0898 ¹	-
HANDLEBARS & HAND CONTROLS		0407-0904 ¹	-	SEF Factory 250/300/450/500 19-24	0407-0897	0407-0915
	SX 200/250/380 00-02	0407-0888	0407-0912		0407-0898 ¹	-
	SX 250 95-96	0407-0890	-	SER 125 19-21	0407-0903	0407-0917
FOOTPEGS & FOOT CONTROLS		0407-0891 ¹	-		0407-0904 ¹	-
	SX 250 03-24	-	0407-0917	SER 250/300 12-21	0407-0903	0407-0917
	SX 360 96	0407-0890	-		0407-0904 ¹	-
BODY		0407-0891 ¹	-	SEF-R 250/300 12-21	0407-0903	0407-0917
	SX 400/520 00-01	0407-0888	0407-0912		0407-0904 ¹	-
	SX 450 03-06	0407-0903	0407-0917	SEF-R 450 18-20	0407-0903	0407-0917
GRAPHICS & SEATS		0407-0904 ¹	-		0407-0904 ¹	-
	SX Racing 525 03-07	0407-0903	-	ST 80 12-17	0407-0880	-
		0407-0904 ¹	-	ST 125/250 12-23	0407-0880	-
SPROCKETS	SX-F 250 07-24	0407-0903	0407-0917	ST 290 17-16	0407-0880	-
		0407-0904 ¹	-	ST 300 17-23	0407-0880	-
	SX-F 350 11-24	0407-0903	0407-0917	SUZUKI		
CHAINS		0407-0904 ¹	-	RM 85 02-24	0407-0877	-
	SX-F 450 03-24	0407-0903	0407-0917	RM 125/250 91-95	0407-0892	0407-0913
		0407-0904 ¹	-	RM 125/250 96-00	0407-0907	0407-0919
BRAKES	EXC 125 96-99	0407-0890	-		0407-0908 ¹	-
		0407-0891 ¹	-	RM 125 01-08	0407-0895	-
	EXC 125/200/250/300/380/400/520 00-02	0407-0888	0407-0912		0407-0896 ¹	-
WHEELS & ACCESSORIES	EXC 125/200 03-16	0407-0903	0407-0917	RM 250 01-03	0407-0893	0407-0914
		0407-0904 ¹	-	RM 250 04-08	0407-0895	-
	EXC 200 98-99	0407-0890	-		0407-0896 ¹	-
ELECTRICAL & GAUGES		0407-0891 ¹	-	RM-Z 250 04-06	0407-0897	0407-0915
	EXC 250 95-96	0407-0890	-		0407-0898 ¹	-
		0407-0891 ¹	-	RM-Z 250 07-12	0407-0895	-
FUEL/AIR SYSTEMS	EXC 250/300 03-24	0407-0903	0407-0917		0407-0896 ¹	-
		0407-0904 ¹	-	RM-Z 250 13-15	0407-0901	0407-0916
	EXC 300 95-96	0407-0890	-		0407-0902 ¹	-
HARDWARE & MERCHANDISING		0407-0891 ¹	-	RM-Z 250 16-18	0407-0899	-
	EXC 360 96	0407-0890	-	RM-Z 250 19-24	0407-0897	0407-0915
		0407-0891 ¹	-		0407-0898 ¹	-
SUSPENSION	EXC 400 03-11	0407-0903	0407-0917	RM-Z 450 04-12	0407-0895	-
		0407-0904 ¹	-		0407-0896 ¹	-
	EXC 440 95	0407-0890	-	RM-Z 450 13-14	0407-0901	0407-0916
ENGINE		0407-0891 ¹	-		0407-0902 ¹	-
	EXC 450 03-16	0407-0903	0407-0917	RM-Z 450 15-24	0407-0907	0407-0919
		0407-0904 ¹	-		0407-0908 ¹	-
LIGHTING	EXC 500 12-16	0407-0903	0407-0917	DR-Z 250 01-07	0407-0887	-
		0407-0904 ¹	-	DR-Z 400E 00-07	0407-0907	0407-0919
	EXC 525 03-07	0407-0903	0407-0917		0407-0908 ¹	-
MONTESA		0407-0904 ¹	-	DR-Z 400K 00-03	0407-0907	0407-0919
	EXC-F 250 07-24	0407-0903	0407-0917		0407-0908 ¹	-
		0407-0904 ¹	-	DR-Z 400S 00-13	0407-0907	0407-0919
OSSA	EXC-F 350 11-24	0407-0903	0407-0917		0407-0908 ¹	-
		0407-0904 ¹	-	DR-Z 400SM 04-08	0407-0895	-
	EXC-F 450/500 17-24	0407-0903	0407-0917		0407-0896 ¹	-
SCORPA		0407-0904 ¹	-	TM RACING		
	EXC-G Racing 400 03-11	0407-0903	0407-0917	MX 85 13-23	0407-0880	-
		0407-0904 ¹	-	MX 125/250 96-04	0407-0890	-
Ossa	EXC-G Racing 525 03-07	0407-0903	0407-0917		0407-0891 ¹	-
		0407-0904 ¹	-	MX 125/144/250/300 07-12	0407-0909	-
	EXC-R 450 03-11	0407-0903	-		0407-0910 ¹	-
Freeride		0407-0904 ¹	-	MX 125/144/250/300 13-24	0407-0897	0407-0915
	EXC-R 530 08-11	0407-0903	-		0407-0898 ¹	-
		0407-0904 ¹	-	MX 250 F102-04	0407-0890	-
Freeride	Freeride 250R 14-17	0407-0888	-		0407-0891 ¹	-
	Freeride 350 12-17	0407-0888	-	MX 250 Fi/450 Fi 07-12	0407-0909	-
		0407-0888	-		0407-0910 ¹	-
Cota	MONTESA			MX 250 Fi/450 Fi 13-24	0407-0897	0407-0915
	Cota 260 4RT 05-13	0407-0879	-		0407-0898 ¹	-
	Cota 260 4RT 14-23	0407-0880	-	MX 300 97-05	0407-0890	-
Cota	Cota 260 4RT Repsol Replica 05-13	0407-0880	-		0407-0891 ¹	-
	Cota 315R 00-04	0407-0879	-	MX 300 Fi 16-24	0407-0897	-
		0407-0879	-		0407-0898 ¹	-
Ossa	OSSA			MX 450 Fi 04	0407-0890	-
	TR 125/250/280/300 15-16	0407-0881	-		0407-0891 ¹	-
	SCORPA			MX 530F 02-04	0407-0890	-
SCORPA	SC 125 Racing 11-13	0407-0881	-		0407-0891 ¹	-
	SC 125/250/300 Factory 11-13	0407-0881	-		0407-0890	-
	TRide 290 12-16	0407-0881	-		0407-0891 ¹	-

¹ Heavy duty.



FRONT FORK SEALS (CONT)

FITS MODEL	STANDARD KIT PART #	DUAL COMPOUND PART #
TM RACING (CONT)		
MX 530F 07-16	0407-0909	-
	0407-0910¹	-
EN 125/250 96-04	0407-0890	-
	0407-0891¹	-
EN 125/144/250/300 07-17	0407-0909	-
	0407-0910¹	-
EN 125/144/250 13-24	0407-0897	0407-0915
	0407-0898¹	-
EN 250 Fi/300 Fi 2T 20-24	0407-0897	-
	0407-0898¹	-
EN 250F 4T 02-04	0407-0890	-
	0407-0891¹	-
EN 250F 4T 07-17	0407-0909	-
	0407-0910¹	-
EN 250F/350F 4T 13-24	0407-0897	-
	0407-0898¹	-
EN 530F 02-04	0407-0890	-
	0407-0891¹	-
EN 530F 07-17	0407-0909	-
	0407-0910¹	-
YAMAHA		
YZ 65 18-24	0407-0876	-
YZ 85 02-24	0407-0876	-
YZ 125 96-03	0407-0893	0407-0914
YZ 125/250/450 04-24	0407-0897	0407-0915
	0407-0898¹	-

SIZE CHART

PART #	ID X OD X H (DUST SEAL/MM)	ID X OD X H (OIL SEAL/MM)
0407-0872	32 x 44,4 x 4,9	32 x 42 x 6,5
0407-0873	35 x 47,4 x 4,9	35 x 47 x 10
0407-0874	35 x 47 x 4,7	35 x 46 x 11
0407-0875	35 x 47 x 4,7	35 x 45 x 7,9
0407-0876	36 x 48,5 x 5,7	36 x 48,1 x 8
0407-0877	37 x 50,3 x 5,6	37 x 50 x 11
0407-0878	38 x 4,8 x 50,4	38 x 50 x 7,5
0407-0879	39 x 52,3 x 4,8	39 x 52 x 11
0407-0880	39 x 51,5 x 4,8	39 x 51,05 x 7,7
0407-0881	40 x 52,45 x 4,8	40 x 52,25 x 9,8
0407-0882	41 x 53,55 x 5	41 x 53,1 x 7,5
0407-0883	41 x 54,4 x 5,8	41 x 54 x 9
0407-0884	43 x 55,55 x 5	43 x 55,1 x 9
0407-0887	43 x 54,35 x 5	43 x 54 x 9
0407-0888	43 x 53,4 x 5,8	43 x 52,9 x 9,5
0407-0890	45 x 58,4 x 5,5	45 x 58 x 11
0407-0891	45 x 58,4 x 5,5	45 x 58 x 11
0407-0892	45 x 57,35 x 5,5	45 x 57 x 11,2
0407-0893	46 x 57,35 x 5,5	46 x 58,15 x 8,5
0407-0895	48 x 58,4 x 5,7	47 x 58 x 10
0407-0896	48 x 58,4 x 5,7	47 x 58 x 10
0407-0897	48 x 58,4 x 4,9	48 x 58,1 x 8,5

FITS MODEL	STANDARD KIT PART #	DUAL COMPOUND PART #
YAMAHA (CONT)		
YZ 125X 20-24	0407-0897	0407-0915
	0407-0898¹	-
YZ 250F 01-03	0407-0893	0407-0914
YZ 250FX 15-24	0407-0897	0407-0915
	0407-0898¹	-
YZ 250X 16-24	0407-0897	0407-0915
	0407-0898¹	-
YZ 400F 98-99	0407-0893	0407-0914
YZ 426F 00-02	0407-0893	0407-0914
YZ 450F 03	0407-0893	0407-0914
YZ 450FX 16-24	0407-0897	0407-0915
	0407-0898¹	-
WR 125/250 96-03	0407-0893	0407-0914
WR 250F 01-04	0407-0893	0407-0914
WR 250F/450F 05-24	0407-0897	0407-0915
	0407-0898¹	-
WR 400F 98-00	0407-0893	0407-0914
WR 426F 00-02	0407-0893	0407-0914
WR 450F 03-04	0407-0893	0407-0914
TT 600 00-03	0407-0893	0407-0914

¹ Heavy duty.

PART #	ID X OD X H (DUST SEAL/MM)	ID X OD X H (OIL SEAL/MM)
0407-0898	48 x 58,4 x 4,9	48 x 58,1 x 8,5
0407-0899	48 x 58,4 x 4,9	48 x 58,1 x 8,5
0407-0900	48 x 58,4 x 5,7	48 x 58,1 x 8,5
0407-0901	48 x 58,4 x 5,7	48 x 58,1 x 8,5
0407-0902	48 x 58,4 x 5,7	48 x 58,1 x 8,5
0407-0903	48 x 58,4 x 5,7	48 x 57,9 x 9
0407-0904	48 x 58,4 x 5,7	48 x 57,9 x 9
0407-0905	48 x 58,4 x 5,7	48 x 57,9 x 9
0407-0906	48 x 58,4 x 5,7	48 x 57,9 x 9
0407-0907	49 x 60,3 x 6	49 x 60 x 10
0407-0908	49 x 60,3 x 6	49 x 60 x 10
0407-0909	50 x 63,40 x 4,7	50 x 63 x 11
0407-0911	43 x 54,35 x 5	43 x 54 x 9
0407-0912	43 x 53,4 x 5,2	43 x 52,9 x 9,5
0407-0913	45 x 57,35 x 5	45 x 57,1 x 11,2
0407-0914	46 x 58,7 x 5	46 x 58,15 x 8,5
0407-0915	48 x 58,4 x 4,9	48 x 58,1 x 8,5
0407-0916	48 x 58,4 x 4,9	48 x 58,1 x 8,5
0407-0917	48 x 58,4 x 4,8	48 x 57,9 x 9
0407-0918	48 x 58,4 x 4,9	48 x 57,9 x 9
0407-0919	49 x 60,3 x 5,2	49 x 60 x 10

FORK ROD CARTRIDGE SEALS

- Meticulously crafted from superior low-friction NBR compounds
- Ensures damping performance with reliable fluid separation inside the fork
- Allows the use of different fork fluids inside the fork assembly to optimize overall performance
- Lip shapes designed to minimize friction and enhances damping settings for smoother ride
- Compatible with a wide range of OEM and aftermarket suspension fluids
- High efficiency during operation; prevents pressure loss and annoying leaks

FITS MODEL	PART #	FITS MODEL	PART #	FITS MODEL	PART #
GASGAS		HUSQVARNA		KTM	
MC 250F/450F 21-24	0413-0155	TC 125/250 17-24	0413-0155	SX 125/150/300 16-24	0413-0155
MC 350F 22-24	0413-0155	FC 250/350/450 17-24	0413-0155	SX-F 250/350/450 16-24	0413-0155



EXHAUST

LUGGAGE

BIKE STANDS & ACCESSORIES

HANDLEBARS & HAND CONTROLS

FOOTPEGS & FOOT CONTROLS

BODY

GRAPHICS & SEATS

SPROCKETS

CHAINS

BRAKES

WHEELS & ACCESSORIES

SUSPENSION

ELECTRICAL & GAUGES

LIGHTING

ENGINE

FUEL/AIR SYSTEMS

HARDWARE & MERCHANDISING

EXHAUST

LUGGAGE

BIKE STANDS & ACCESSORIES

HANDLEBARS & HAND CONTROLS

FOOTPEGS & FOOT CONTROLS

BODY

GRAPHICS & SEATS

SPROCKETS

CHAINS

BRAKES

WHEELS & ACCESSORIES

SUSPENSION

ELECTRICAL & GAUGES

LIGHTING

ENGINE

FUEL/AIR SYSTEMS

HARDWARE & MERCHANDISING



FORK MUD SCRAPER KITS

- Prevents dirt from entering fork and effectively cleans dried mud from stanchion providing superior water and dirt protection
- Engineered for optimal seal protection
- Feature low-friction plastic material ensuring top-tier performance under severe conditions
- UV-light resistant

- Designed to reduce seal contamination
- User-friendly installation; can be installed in-field without need for fork or wheel removal
- Includes two mud scrapers and stainless steel assembly pins
- Can operate with a long stroke and at high speed

0450-0689



FITS MODEL	PART #
BETA	
RR 250/300 Racing 2T 14-24	0450-0689
RR 250/300 Racing 2T 18-19	0450-0690
RR 350 4T Racing 15-24	0450-0689
RR 430/480 4T Racing 18-19	0450-0690
RR 430/480 4T Racing 15-17, 20-24	0450-0689
RR 2T 125/250/350 18-24	0450-0690
RR 2T 250 13-17	0450-0689
RR 2T 300 13-18, 24	0450-0689
RR 2T 300 19-23	0450-0690
RR 4T 350 12-14	0450-0689
RR 4T 390/430/480 18-24	0450-0690
RR 4T 400 12-14	0450-0689
RR 4T 430/480 15-17	0450-0689
RR 4T 450/498 12-14	0450-0689
FANTIC	
XX 125/250 22-24	0450-0689
XX 125/250 Launch Version 24	0450-0689
XXF 250 22-23	0450-0689
XXF 450 23	0450-0689
XE 125/250 Trail 22-24	0450-0689
XE 125 Launch Version 24	0450-0689
XEF 250/450 22-23	0450-0689
XEF 450 Rally/Rally Factory 23-24	0450-0689
GASGAS	
MC 125/250F/450F 21-23	0450-0691
MC 450F Troy Lee Designs 22	0450-0691
EC 250 18-19	0450-0689
EC 250 Six Days 19	0450-0689
EC 250 20-23	0450-0691
EC 300 11-14	0450-0691
EC 300 18-19	0450-0689
EC 300 E-racing 14-15	0450-0691
EC 300 Ranger 19	0450-0689
EC 250F 21-23	0450-0691
EC 350F 21-23	0450-0691
HONDA	
CR 250 97-07	0450-0688
CR 500 97-01	0450-0688
CRF 250 04-17	0450-0688
CRF 250R 10-14	0450-0690
CRF 250R 15-24	0450-0692
CRF 450 02-08	0450-0688
CRF 450R 09-16	0450-0689
CRF 450R 17-24	0450-0692
CRF 450R 50th Anniversary 23	0450-0692

FITS MODEL	PART #
HONDA (CONT)	
CRF 450RWE 19-24	0450-0692
CRF 450L 19-20	0450-0692
HUSABERG	
TE 125/300 13-14	0450-0691
FE 390 10-12	0450-0691
FE 450 09-12	0450-0691
FE 550/650 04-08	0450-0691
FE 570 09-10	0450-0691
HUSQVARNA	
TC 125/250 14-22	0450-0691
FC 250/350/450 14-22	0450-0691
TE 125 14-16	0450-0691
TE 250/300 18-23	0450-0691
TE 300 14-18	0450-0691
TE 300 Jarvis 20	0450-0691
FE 250/350/450 14-23	0450-0691
FE 501 14-23	0450-0691
KAWASAKI	
KX 125 02-08	0450-0689
KX 250 21-24	0450-0689
KX 250 50th Anniversary 24	0450-0689
KX 250F 04-05, 20	0450-0689
KX 250F 06-12	0450-0688
KX 250F 13-19	0450-0690
KTM	
SX 125 08-24	0450-0691
SX 150 09-24	0450-0691
SX 250 03-24	0450-0691
SX 450/525 Racing 03-06	0450-0691
SX 525 03-06	0450-0691
SX-F 350 11-24	0450-0691
SX-F 450 07-24	0450-0691
SX-F 450 Cairoli 20	0450-0691
SX-F 450 Factory Ed. 12-24	0450-0691
SX-F 450 Herlings Replica 19	0450-0691
SX-F 450 Racing 07-10	0450-0691
EXC 125/200 03-16	0450-0691
EXC 125 Six Days 07-16	0450-0691
EXC 125/450 Champions Ed. 10	0450-0691
EXC 250 03-17	0450-0691
EXC 250 Racing 03-06	0450-0691
EXC 250 Six Days 10-17	0450-0691
EXC 250/300/Six Days 18-23	0450-0691
EXC 300 04-07, 11-17	0450-0691
EXC 300 Erzbergroede 20-23	0450-0691

FITS MODEL	PART #
KTM (CONT)	
EXC 300 Six Days 11-17	0450-0691
EXC 400 03, 09-11	0450-0691
EXC 400/450/525 Racing 03-07	0450-0691
EXC 450 07, 09-16	0450-0691
EXC 450 Six Days 09-16	0450-0691
EXC 500/Six Days 12-16	0450-0691
EXC-F 250 07-23	0450-0691
EXC-F 250 Champions Ed. 10	0450-0691
EXC-F 250 Six Days 09-23	0450-0691
EXC-F 350 Wess 21	0450-0691
EXC-F 350/Six Days 12-23	0450-0691
EXC-F 450/500/Six Days 17-23	0450-0691
EXC-F 450 FE 22	0450-0691
EXC-G 400 Racing 03-06	0450-0691
EXC-G 525 03-06	0450-0691
EXC-R 450/Six Days 08	0450-0691
EXC-R 530 08-10	0450-0691
SHERCO	
SE 125/250/300 19-23	0450-0689
SEF 250/300/450/500 19-23	0450-0689
SER 250/300 14-17	0450-0691
SER 125 Racing 18-21	0450-0691
SER 250 Racing 16-21	0450-0691
SER 300 Racing 18-22	0450-0691
SEF-R 250/300 14-17	0450-0691
SEF-R 250/300 Racing 16-21	0450-0691
SEF-R 450 Racing 18-21	0450-0691
SUZUKI	
RM 125 01-08	0450-0688
RM 250 04-08	0450-0688
RM-Z 250 07-12	0450-0688
RM-Z 250 04-06, 16-25	0450-0689
RM-Z 250 Army Edition 23-24	0450-0689
RM-Z 250 13-15	0450-0690
RM-Z 450 05-12	0450-0688
RM-Z 450 13-14	0450-0690
RM-Z 450 05-25	0450-0692
RM-Z 450 Army Ed. 23-24	0450-0692
DR-Z 400SM 05-08	0450-0688
YAMAHA	
YZ 250F 10-24	0450-0689
YZ 250F/450F 60th Anniversary 16	0450-0689
YZ 250F/450F 50th Anniversary 24	0450-0689
YZ 450F 10-25	0450-0689



FORK SEALS AND DUST SEALS

- Seal profile is engineered to create equal pressure in each seal lip; equalized seal pressure creates less drag and longer seal life
- MAX-LIFE has a coefficient of friction up to three times less than the OEM seal material
- Triple-lip seal design
- Directional ribs allow seal to be installed easily

FITS MODEL	FORK OIL SEAL/DUST SEAL KIT PART #
HONDA	
CR 125R 87	0407-0960
CR 500R 85-87	0407-0960

FITS MODEL	FORK OIL SEAL/DUST SEAL KIT PART #
KAWASAKI	
KX 80 79-81	0407-0960



- EXHAUST
- LUGGAGE
- BIKE STANDS & ACCESSORIES
- HANDLEBARS & HAND CONTROLS
- FOOTPEGS & FOOT CONTROLS
- BODY
- GRAPHICS & SEATS
- SPROCKETS
- CHAINS
- BRAKES
- WHEELS & ACCESSORIES
- SUSPENSION**
- ELECTRICAL & GAUGES
- LIGHTING
- ENGINE
- FUEL/AIR SYSTEMS
- HARDWARE & MERCHANDISING



FRONT FORK SERVICE KITS

- Contain everything needed to rebuild a set of front forks
- Each kit includes grease, two oil seals, two dust seals, two piston metal sets and two slide metal sets
- Order one kit per bike
- See page 1067 of the 2024 Parts Europe Offroad catalog for the complete line of KYB front fork service kits

FITS MODEL	PART #
KAWASAKI	
KX 80 98-00	0450-0686
KX 85 02-25	0450-0686
KX 100 95-02	0450-0686

0450-0685



FITS MODEL	PART #
YAMAHA	
YZ 65 19-25	0450-0686
YZ 80/85 93-25	0450-0686
Tenere 700 19-25, World Raid 700 22-25	0450-0685



FRONT FORK DUST SEAL SET

- Dimensions: 48 mm
- See page 1068 of the 2024 Parts Europe Offroad catalog for the complete line of KYB front fork dust seal sets

APPLICATIONS

FITS MODEL	PART #
BETA	
RR Racing 2T 125/250/300 20-24	0407-0849
RR Racing 4T 350/390/430/480 20-24	0407-0849
FANTIC	
XX 125/250 20-23	0407-0849
XE 125 20-23	0407-0849
GASGAS	
EC 250/300 18-20	0407-0849
HONDA	
CRF 250R 10-14	0407-0849
CRF 450R 09-16	0407-0849
KAWASAKI	
KX 125/250 02-08	0407-0849
KX 250F 04-05/13-18, KX 250 19-24	0407-0849
KX 450F 06-14	0407-0849
KLX 450R 07-09	0407-0849



FITS MODEL	PART #
RIEJU	
MR PRO 250/300 21-24	0407-0849
MR RACING 250/300 21-24	0407-0849
SHERCO	
SC/SCF Factory 19-24	0407-0849
SE/SEF Factory 19-24	0407-0849
SUZUKI	
RM-Z 250 04-06/13-24	0407-0849
RM-Z 450 13-14	0407-0849
TM	
MX 13-24, MX Fi (all) 13-23	0407-0849
YAMAHA	
YZ 125/250 04-24	0407-0849
YZ 250F 04-24	0407-0849
YZ 450F 04-24	0407-0849
WR 250F 05-24	0407-0849
WR 450F 05-24	0407-0849



0407-0859



0407-0851



FORK SEAL/BUSHING KITS

- Come with everything needed to do the job right the first time
- Kits contain fork seals, wipers and upper and lower bushings
- See pages 1071-1072 of the 2024 Parts Europe Offroad catalog for the complete line of Pivot Works fork seal/bushing kits

FITS MODEL	PART #
HONDA	
CRF 250R 18-22	0407-0859
CRF 450R 17-22	0407-0859

FITS MODEL	PART #
KAWASAKI	
KX 125/250 99-03	0407-0850
KX 450 19-22	0407-0851

FITS MODEL	PART #
SUZUKI	
RM-Z 250 16-18	0407-0852
RM-Z 250 19-22	0407-0854
RM-Z 450 18-20	0407-0853

EXHAUST

LUGGAGE

BIKE STANDS & ACCESSORIES

HANDLEBARS & HAND CONTROLS

FOOTPEGS & FOOT CONTROLS

BODY

GRAPHICS & SEATS

SPROCKETS

CHAINS

BRAKES

WHEELS & ACCESSORIES

SUSPENSION

ELECTRICAL & GAUGES

LIGHTING

ENGINE

FUEL/AIR SYSTEMS

HARDWARE & MERCHANDISING



FORK BUSHING KIT

- PTFE-coated bushings are dyno-tested to 500.000 strokes with less wear than OEM
- Kit includes two slider bushings and two leg bushings
- Kit includes all copper washers and O-rings

FITS MODEL	PART #
HONDA	
CRF 110F 14-24	0450-0687
CRF 125F/FB 14-24	0450-0687



- Kit includes two fork seal snap rings
- See pages 1090-1092 of the 2024 Parts Europe Offroad catalog for the complete line of Moose Racing fork bushing kits

FITS MODEL	PART #
HONDA (CONT)	
XR 150L 23	0450-0687



FORK BUSHING KITS

- Maintenance free bushings that combine the robustness of steel with the low friction of a PTFE-based self-lubricating sliding layer
- Composite fork bushing eliminates the need for regular maintenance while still ensuring consistent performance
- Thin bronze layer forms a robust bond between the backing and sliding surfaces to enhance heat dissipation
- Steel body ensures strength and is copper plated to safeguard against corrosion
- PTFE-based sliding surface minimizes friction and provides a low-wear performance
- Widely adopted in premium motorcycle applications globally

FITS MODEL	PART #	FITS MODEL	PART #	FITS MODEL	PART #	FITS MODEL	PART #
BETA		GASGAS (CONT)		HUSQVARNA (CONT)		KAWASAKI (CONT)	
Minicross 50R 12 05	0450-0713	EC 200 14	0450-0700	TC 85 14-25	0450-0714	KX 250F 06-12	0450-0710
RR 125/250/300/350/390/430/480 Racing 20-25	0450-0699	EC 200 Racing 14	0450-0700	TC 125/250 14-25	0450-0715	KX 250F 13-19	0450-0711
RR 200 2T Racing 21-25	0450-0715	EC 200/300 Ranger 19	0450-0697	TC 125/250 Heritage 23	0450-0715	KX 250 50th Anniversary 24-25	0450-0699
RR 250 2T Racing 17-23	0450-0715	EC 250 03-11	0450-0700	TC 250/450 03-09	0450-0700	KTM	
RR 300/350/390/430/480 Racing 17-19	0450-0715	EC 250 Racing 13-14	0450-0700	TC 450 06-09	0450-0702	SX 50 09-25	0450-0713
RR 2T 125 18-25	0450-0715	EC 250 21-25	0450-0715	TC 450 11-13	0450-0699	SX 65 02-25	0450-0713
RR 2T 200 19-25	0450-0715	EC 250F/300F/450F 13	0450-0701	TC 510 05	0450-0700	SX 85 03-25	0450-0714
RR 2T 250 13-18, 24-25	0450-0715	EC 250F Cami 14	0450-0701	TC 570 01-02	0450-0700	SX 125 96-98	0450-0700
RR 4T 350 11-25	0450-0715	EC 250F/300F/450F Racing 14-15	0450-0701	TC 610 99-00	0450-0700	SX 125/250 03-25	0450-0715
RR 4T 390 17-25	0450-0715	EC 250F/350F 21-25	0450-0715	FC 250/350/450 14-25	0450-0715	SX 144 08	0450-0715
RR 4T 400 06-10	0450-0700	EC 300E 11, 13-14	0450-0700	FC 250/350/450 Heritage 23	0450-0715	SX 150 09-25	0450-0715
RR 4T 400 11-12	0450-0701	EC 400FSE 03	0450-0700	TE 125 14-16	0450-0715	SX 250 95-96	0450-0700
RR 4T 400/450 13-14	0450-0715	FSR 450 07-08	0450-0700	TE 150 17	0450-0715	SX 250 24-25	0450-0715
RR 4T 430 17-19	0450-0715	HONDA		TE 150 20-25	0450-0715	SX/EXC/MXC 360 96	0450-0700
RR 4T 450 06-11	0450-0702	CR 80RB 96-02	0450-0704	TE 250 03-07	0450-0700	SX 450/525 Racing 03-06	0450-0715
RR 4T 480 17-25	0450-0715	CR 85R 03-07	0450-0704	TE 250 08-09	0450-0702	SX-F 250/450 07-25	0450-0715
RR 4T 498 13-14	0450-0715	CR 125R 97-07	0450-0697	TE 250/300 14-25	0450-0715	SX-F 250 FE 15-17, 22	0450-0715
FANTIC		CR 150R 07-25	0450-0704	TE 300 Jarvis 20	0450-0715	SX-F 250 Prado 20	0450-0715
XX 125/250 22-25	0450-0699	CR 250R 96	0450-0697	TE 400 01	0450-0700	SX-F 350 11-24	0450-0715
XXF 450 23-25	0450-0699	CR 250R 97-07	0450-0710	TE 410 96-00	0450-0700	SX-F 450 Cairoli 20	0450-0715
XE 125 22-25	0450-0699	CR 500R 96-01	0450-0697	TE 450 03-05	0450-0700	SX-F 450 FE 12-25	0450-0715
XEF 250/450 22-25	0450-0699	CRF 150R Expert 22-25	0450-0704	TE 450/510 06-09	0450-0702	SX-F 450 Herlings Replica 19	0450-0715
XEF 250 Trail 23-25	0450-0699	CRF 150RB 07-17	0450-0704	TE 450 10	0450-0699	EXC/EGS 125 96-99	0450-0700
XEF 450 Rally/Rally Factory 23-25	0450-0699	CRF 250R 04-09	0450-0710	TE 510/Centennial 04-05	0450-0700	EXC 125 03-16	0450-0715
GASGAS		CRF 250R 15-25	0450-0712	TE 511 11-13	0450-0699	EXC 125/530 Champions Ed. 10	0450-0715
MC 50/65 21-25	0450-0713	CRF 450R 02-08	0450-0710	TE 570 01-03	0450-0700	EXC 125 Six Days 07-16	0450-0715
MC 85 17/14 BW 22-25	0450-0714	CRF 450R 15-25	0450-0712	TE 610 99-01, 06-07	0450-0700	EXC 150 20-25	0450-0715
MC 85 19/16 BW 21-25	0450-0714	CRF 450R 50th Anniversary 23	0450-0712	TE 630 10-11	0450-0700	EXC/MXC 200 98-99	0450-0700
MC 125 03-07	0450-0700	CRF 450RWE 19-22	0450-0712	FE 250/350/450/501 14-25	0450-0715	EXC 200 03-16	0450-0715
MC 125 21-25	0450-0715	CRF 450L 19-20	0450-0712	FE 390 10-12	0450-0715	EXC/EGS 250/300 95-96	0450-0700
MC 250 03-09	0450-0700	HUSABERG		KAWASAKI		EXC 250 03-17	0450-0715
MC 250F/450F 21-25	0450-0715	TE 125 12-14	0450-0715	KX 80 98-00	0450-0693	EXC 250/300 Six Days 11-25	0450-0715
MC 250F/450F FE 24-25	0450-0715	TE 250 11-14	0450-0715	KX 85 17/14 02-25	0450-0693	EXC 300 03-07, 11-17	0450-0715
MC 450F Factory/Prado 25	0450-0715	FE 350 13	0450-0715	KX 100 06-21	0450-0693	EXC 300 18-25	0450-0715
MC 450F Troy Lee Designs 22	0450-0715	FE 450 09-13	0450-0715	KX 125 95-01	0450-0697	EXC 300 Erzsberggradeo 20-23	0450-0715
EC 125 03-10	0450-0700	FE 550 04-08	0450-0715	KX 125/250 02-03	0450-0715	EXC 300 Hardenduro 24-25	0450-0715
EC 125 Racing 13-15	0450-0700	FE 570 09-12	0450-0715	KX 250 96-01	0450-0697	EXC 400 03, 09-11	0450-0715
EC 200 03-09	0450-0700	HUSQVARNA		KX 500 01-04	0450-0697		
		TC 50 17-25	0450-0713	KX 250F 05-05, 20-25	0450-0699		
		TC 65 17-25	0450-0713				

0450-0699



SKF® FORK BUSHING KIT (CONT)

FITS MODEL	PART #
KTM (CONT)	
EXC 400/450/525 Racing 03-07	0450-0715
EXC 440 95	0450-0700
EXC 450 07-25	0450-0715
EXC 450 Six Days 09-25	0450-0715
EXC 500 12-16	0450-0715
EXC 500 Six Days 12-16	0450-0715
EXC 530 08-11	0450-0715
EXC 530 Six Days 09-11	0450-0715
EXC-F 250 07-25	0450-0715
EXC-F 250 Six Days 10-25	0450-0715
EXC-F 350 12-25	0450-0715
EXC-F 350 FE 22	0450-0715
EXC-F 350 Six Days 12-25	0450-0715
EXC-F 350 Wess 21	0450-0715
EXC-F 500 17-25	0450-0715
EXC-F 500 Six Days 17-25	0450-0715
EXC-G 525 Racing 03-06	0450-0715
EXC-R 530 08-10	0450-0715
SHERCO	
SE 125 Factory 18	0450-0715
SE 125/250/300 Factory 19-25	0450-0699
SE 250/300 14-15	0450-0715
SE 250/300 Factory 18	0450-0715
SEF 250/300 14-15	0450-0715
SEF 250/450 Factory 18	0450-0715
SEF 250/300/450/500 Factory 19-25	0450-0699
SEF 300 Factory 18-21	0450-0715
SEF 450 15	0450-0715

FITS MODEL	PART #
SHERCO (CONT)	
SEF 500 Factory 19-20	0450-0715
SEF-R 250 14-17	0450-0715
SEF-R 250/450 Racing 16-21	0450-0715
SEF-R 450 15-17	0450-0715
SER 125 Racing 18-20	0450-0715
SER 250/300 14-17	0450-0715
SER 250/300 Racing 16-21	0450-0715
SWM	
RS300R 16-22	0450-0699
RS340S 16	0450-0699
RS400R 16-20	0450-0699
SUZUKI	
RM 85 17/14 02-18	0450-0704
RM 85 17/14 19-25	0450-0704
RM 125 01-10	0450-0710
RM 250 01-02	0450-0697
RM 250 03	0450-0698
RM 250 04-10	0450-0710
RM-Z 250 04-06, 19-25	0450-0699
RM-Z 250 07-12	0450-0710
RM-Z 250 13-15	0450-0711
RM-Z 250 Army Ed. 23-25	0450-0699
RM-Z 450 05-25	0450-0712
RM-Z 450 13-14	0450-0711
RM-Z 450 Army Ed. 23-25	0450-0712
RMX 450Z 12-17	0450-0710
TM RACING	
MX 125/250/300 01-04	0450-0700
MX 125/250 07-12	0450-0702
MX 125/144 13-21	0450-0699

FITS MODEL	PART #
TM RACING (CONT)	
MX 144 08-12	0450-0702
MX 250Fi/450Fi 11-12	0450-0702
MX 250/300 13-20	0450-0699
MX 250Fi/450Fi 13-21	0450-0699
MX 300 07-09, 11-17	0450-0702
MX 530F 03-04	0450-0700
EN 125/250/300/530F 04	0450-0700
EN 125/250/300 04-17	0450-0702
EN 125/144 13-19	0450-0699
EN 144 08-17	0450-0702
EN 250/300 13-20	0450-0699
EN 250 Fi/300 Fi ES 2T 21	0450-0699
EN 250F 02-04	0450-0700
EN 300Fi 17-21	0450-0699
EN/MX 530F 07-14	0450-0702
SMR 125 15-20	0450-0702
SMX 450Fi 18-21	0450-0702
SMX 450Fi Competition 15-17	0450-0702
TRIUMPH	
TF 250-X 24-25	0450-0699
YAMAHA	
YZ 65 18-25	0450-0693
YZ 125 96-03	0450-0697
YZ 125 04-25	0450-0693
YZ 125/250 50th Anniversary Ed. 24-25	0450-0693
YZ 125/250 Monster Energy Racing Ed. 22-23	0450-0693
YZ 250 96-03	0450-0697
YZ 250 04-25	0450-0693

FITS MODEL	PART #
YAMAHA (CONT)	
YZ 250/F 04-25	0450-0699
YZ 250F 01-03	0450-0697
YZ 250F/450F 60th Anniversary 16	0450-0699
YZ 250F Monster Energy Racing Ed. 21-23	0450-0699
YZ 250F/450F 50th Anniversary Ltd. Ed. 06, 24	0450-0699
YZ 400F 98-99	0450-0697
YZ 426F 00-02	0450-0697
YZ 450F 03	0450-0697
YZ 450F 04-25	0450-0699
YZ 450F Monster Energy Racing Ed. 21-25	0450-0699
WR 250F 02-03	0450-0697
WR 250F 05-25	0450-0699
WR 250F/450F 04	0450-0698
WR 250F/450F EnduroGP 18	0450-0699
WR 400F 99-00	0450-0697
WR 426F 01-02	0450-0697
WR 450F 03	0450-0697
WR 450F 05-25	0450-0699



46/50 MM FORK CAP WRENCH

- For removing the caps on Showa MX forks
- One end is 46 mm, the other is 50 mm
- Can be used for removal of the compression stack
- CNC machined for precise fit and tolerance
- 6061 aluminum material is non-marring on fork caps



DESCRIPTION	PART #
46 mm/50 mm fork cap wrench	3805-0162



FRONT FORK OIL

SS05

- 15,1 cSt at 40 °C (104 °F) in bright red color
- High-performance, front fork oil for high-hydraulic speeds; increases front fork rider feeling compared with OEM oil
- Low friction and longer durability
- Can be used both on- and off-road

DESCRIPTION	SHOWA REFERENCE #	PART #
SS05		
5 L	L598005005	3608-0035
20 L	L598005020	3608-0021



3608-0021



3608-0037

A15-00

- 15,1 cSt at 40 °C (104 °F) in orange color
- Reduces the friction and gives more feeling to the rider; developed in MXGP and AMA
- Low friction in low speed
- Can be used both on- and off-road

DESCRIPTION	SHOWA REFERENCE #	PART #
A15-00		
1 L	L598A15001	3608-0022
5 L	L598A15005	3608-0037

EXHAUST

LUGGAGE

BIKE STANDS & ACCESSORIES

HANDLEBARS & HAND CONTROLS

FOOTPEGS & FOOT CONTROLS

BODY

GRAPHICS & SEATS

SPROCKETS

CHAINS

BRAKES

WHEELS & ACCESSORIES

SUSPENSION

ELECTRICAL & GAUGES

LIGHTING

ENGINE

FUEL/AIR SYSTEMS

HARDWARE & MERCHANDISING

EXHAUST



LUGGAGE

TTX FLOW DV SHOCK ABSORBERS

- TTX-technology
- New efficient high speed compression adjuster
- New compression valve interface for optional pressure control
- New rebound needle and shaft jet design
- Stronger 16 mm shaft
- Patent pending flow valve dynamic control
- Great bottoming resistance
- Easy spring change due to unique spring clip design
- Wide range of optional springs



BIKE STANDS & ACCESSORIES

HANDLEBARS & HAND CONTROLS

FOOTPEGS & FOOT CONTROLS

BODY

GRAPHICS & SEATS

SPROCKETS

CHAINS

BRAKES

WHEELS & ACCESSORIES

SUSPENSION

ELECTRICAL & GAUGES

LIGHTING

ENGINE

FUEL/AIR SYSTEMS

HARDWARE & MERCHANDISING

FITS MODEL	PART #
GASGAS	
MC 300 25	1310-2458
MC 250F 24-25	1310-2458
MC 350F 24-25	1310-2458
MC 450F 24	1310-2459
HUSQVARNA	
TC 125 23	1310-2457
TC 250 23	1310-2457
TC 300 25	1310-2458

FITS MODEL	PART #
HUSQVARNA (CONT)	
FC 250 23-25	1310-2458
FC 350 23-25	1310-2458
FC 450 23	1310-2459
KTM	
SX 300 23-25	1310-2458
SX-F 250 23-25	1310-2458
SX-F 350 23-25	1310-2458
SX-F 450 23	1310-2459

FITS MODEL	PART #
KTM (CONT)	
EXC 150 24	1310-2460
EXC 250/Six Days 24	1310-2460
EXC 300 24	1310-2461
EXC-F 250/Six Days 24	1310-2460
EXC-F 350/Six Days 24	1310-2460
EXC-F 450/Six Days 24	1310-2461
EXC-F 500/Six Days 24	1310-2461



SHOCK SEAL HEAD COMPLETE KITS

- Designed to enhance suspension performance and increased durability
- Unique and compact solution to maximize stroke and minimize the shock absorber length
- Made of a specially developed NBR compound for temperatures of -40 to 140 °C
- Ensures robust sealing over a wide temperature range
- Plastic back up ring is a key element that reduces friction and wear
- Proprietary designed rebound bumper and mating plate provide smoother kick back and extended operational life
- Static outer diameter seal design allows for easier assembly and removal
- Provides better feel and comfort when riding

1314-0810



FITS MODEL	PART #
GASGAS	
MC 85 21-25	1314-0810
MC 125 21-25	1314-0811
MC 250F/450F 21-25	1314-0811
EC 2T 250 21-25	1314-0811
EC 300E 21-25	1314-0811
EC 250F/350F 21-25	1314-0811
HONDA	
CR 125R 97-07	1314-0806
CR 250R 95-96	1314-0806
CR 250R 97-08	1314-0809
CR 500R 95-01	1314-0806
CRF 250R 04-25	1314-0809
CRF 450R 02-08	1314-0809
CRF 450R 09-16	1314-0807
CRF 450RWE 17-23	1314-0809
HUSABERG	
TE 125/250/300 12-14	
FE 390/450/570 12-14	1314-0813
HUSQVARNA	
TC 85 14-25	1314-0810
TC 125 /250 14-15	1314-0812
TC 125 16-25	1314-0811
TC 250 12-13	1314-0806
TC 250 17-25	1314-0811
TC 450 11-13	1314-0806
FC 250/350/450 14-15	1314-0812
FC 250/350/450 16-25	1314-0811
TE 125 14-17	1314-0812
TE 250/310 12-13	1314-0806
TE 250/300 14-16	1314-0812
TE 250/300 17-25	1314-0811

FITS MODEL	PART #
HUSQVARNA (CONT)	
TE 310 12-13	1314-0806
FE 250/350/450/501/510 14-16	1314-0812
FE 250/350/450/501/510 17-25	1314-0811
KAWASAKI	
KX 125/250 00-08	1314-0806
KX 250 20-25	1314-0809
KX 250F 04-05	1314-0806
KX 250F 06-19	1314-0809
KTM	
SX 85 08-25	1314-0810
SX 125 00-11	1314-0813
SX 125/150/250 12-15	1314-0812
SX 125/150/250 16-25	1314-0811
SX 144 07-08	1314-0813
SX 150 09-11	1314-0813
SX 200 03-04	1314-0813
SX 250 00-11	1314-0813
SX 400 01-02	1314-0813
SX 450 03-11	1314-0813
SX-F 250 05-11	1314-0813
SX-F 250/350/450 11-15	1314-0812
SX-F 250/350/450 16-25	1314-0811
SX-F 450 07-11	1314-0813
SXC 400 00	1314-0813
SXS 125 01-08	1314-0813
SXS 250 01-04	1314-0813
SXS 450 04-08	1314-0813
SXS-F 250 08	1314-0813
EXC 125/200/250/300 00-16	1314-0813
EXC 250/300 17-25	1314-0810
EXC 400 00-06	1314-0813

FITS MODEL	PART #
KTM (CONT)	
EXC 450 03-16	1314-0813
EXC 500 12-16	1314-0813
EXC-F 250 00-16	1314-0813
EXC-F 250/350/450/500 17-25	1314-0810
EXC-F 350 12-16	1314-0813
SHERCO	
SEF-R 250/300 13-16	1314-0810
SEF-R 450 15-16	1314-0810
SUZUKI	
RM 250 01-03	1314-0806
RM-Z 250 04-06	1314-0806
RM-Z 250 16-25	1314-0807
YAMAHA	
YZ 125 06-25	1314-0808
YZ 125 93-05	1314-0806
YZ 250 93-05	1314-0806
YZ 250 06-25	1314-0808
YZ 250F 01-05	1314-0806
YZ 250F 06-11	1314-0808
YZ 250F 12-13	1314-0806
YZ 250F 14-25	1314-0807
YZ 450F 03-05	1314-0806
YZ 450F 06-09	1314-0808
YZ 450F 10-25	1314-0807
YZ 250FX 15-25	1314-0807
YZ 450FX 16-25	1314-0807
YZ 450SM 10-16	1314-0807
WR 250F 01-13	1314-0806
WR 250F 15-25	1314-0807
WR 450F 03-15	1314-0806

- EXHAUST
- LUGGAGE
- BIKE STANDS & ACCESSORIES
- HANDLEBARS & HAND CONTROLS
- FOOTPEGS & FOOT CONTROLS
- BODY
- GRAPHICS & SEATS
- SPROCKETS
- CHAINS
- BRAKES
- WHEELS & ACCESSORIES
- SUSPENSION**
- ELECTRICAL & GAUGES
- LIGHTING
- ENGINE
- FUEL/AIR SYSTEMS
- HARDWARE & MERCHANDISING



SHOCK SEAL HEAD REPLACEMENT KITS

- Overhaul kit for mono-shock absorbers
- Meticulously designed to provide a precise response to terrain irregularities
- Uses high-quality materials
- Includes necessary components for periodic maintenance of the mono-shock absorber on offroad motorcycles equipped with SKF's innovative seal head unit
- Designed for seamless installation directly onto the rigid support and is fully integrated with other shock absorber components



1314-0819

FITS MODEL	PART #	FITS MODEL	PART #	FITS MODEL	PART #	FITS MODEL	PART #
GASGAS		HUSQVARNA (CONT)		KTM (CONT)		SUZUKI	
MC 125/250F/450F 21-25	1314-0819	TC 250 17-25	1314-0818	SX 200 03-04	1314-0820	RM 250 01-03	1314-0814
EC 250 2T 21-25	1314-0819	TC 450 11-13	1314-0814	SX 250 00-11	1314-0820	RM-Z 250 04-06	1314-0814
EC 250F/350F 21-25	1314-0819	FC 250/350/450 14-25	1314-0818	SX 400 01-02	1314-0820	RM-Z 250 16-25	1314-0815
EC 300E 21-25	1314-0819	TE 125 14-17	1314-0818	SX 450 03-11	1314-0820	YAMAHA	
HONDA		TE 250/310 12-13	1314-0814	SX-F 250 05-11	1314-0820	YZ 125 06-25	1314-0816
CR 250R 97-07	1314-0817	TE 250/300 17-25	1314-0818	SX-F 250/350/450 16-25	1314-0819	YZ 250 06-25	1314-0816
CRF 250R 04-25	1314-0817	FE 250 14-25	1314-0818	SX-F 450 07-11	1314-0820	YZ 250F 06-11	1314-0816
CRF 450R 02-08	1314-0817	FE 350/450/501/510 17-25	1314-0818	EXC 125 00-16	1314-0820	YZ 250F 14-25	1314-0815
CRF 450R 09-16	1314-0815	KAWASAKI		EXC 200 00-12	1314-0820	YZ 450F 06-09	1314-0816
CRF 450R 17-25	1314-0817	KX 125/250 00-08	1314-0814	EXC 250/300 00-16	1314-0820	YZ 450F 10-25	1314-0815
CRF 450RWE 17-23	1314-0817	KX 250F 04-05	1314-0814	EXC 250/300 17-25	1314-0818	YZ 250FX 15-25	1314-0815
HUSABERG		KX 250F 06-25	1314-0817	EXC 400 00-06	1314-0820	YZ 450FX 16-25	1314-0815
TE 125/250/300 12-14	1314-0820	KTM		EXC 450 03-16	1314-0820	YZ 450SM 10-16	1314-0815
FE 390/450/570 12-14	1314-0820	SX 125 00-11	1314-0820	EXC 500 12-16	1314-0820	WR 250F 15-25	1314-0815
HUSQVARNA		SX 125/150/250 16-25	1314-0819	EXC-F 250 00-16	1314-0820	WR 450F 03-20	1314-0814
TC 125 16-25	1314-0818	SX 144 07-08	1314-0820	EXC-F 350 12-16	1314-0820		
TC 250 12-13	1314-0814	SX 150 09-11	1314-0820	EXC-F 350/450/500 17-25	1314-0818		



PISTON SEAL

- Designed for optimal oil/air retention in both 2-wheel fork and shock absorber applications
- Crafted with superior low-friction NBR compounds and a refined seal design
- Dynamic lips supported by strategically placed back-up rings ensure stability and consistent performance across various pressures
- Inclusion of metal insert in the design ensures an optimal seal contact pattern between the piston seal, shaft and housing
- Engineered with reduced axial space to create more room for the damping chamber contributing to improved overall performance
- Compatible with a wide range of OEM and aftermarket suspension fluids
- Streamlined installation process allowing riders to enjoy cutting-edge hassle-free technology



0407-0861

FITS MODEL	PART #	FITS MODEL	PART #	FITS MODEL	PART #	FITS MODEL	PART #
HUSQVARNA		KTM		KTM (CONT)		KTM (CONT)	
TC 125/250 17-20	0407-0861	SX 125/150 16-20	0407-0861	SX-F 250 FE 16-17	0407-0861	SX-F 450 Cairoli 20	0407-0861
FC 250/350/450 17-20	0407-0861	SX 250 17-20	0407-0861	SX-F 250 Prado 20	0407-0861	SX-F 450	
		SX-F 250/350/450 16-20	0407-0861	SX-F 450 FE 16-20	0407-0861	Herlings Replica 19	0407-0861



SHOCK ABSORBER RESERVOIR BLADDER CONVERSION

- Designed to reduce the amount of friction generated inside the shock absorber and increase the gas volume inside the reservoir
- This improves compliance on low-speed movements of the rear wheel and makes the shock react more consistently over differing temperature ranges
- Improves rear wheel traction

- Reduces shock temperature
- Better damping stability
- Reduces friction

NOTE: Recommended to be installed by a suspension specialist as specific tools are required to disassemble the shock, please refer to the fitting instructions.



1313-0255

DESCRIPTION	PART #	DESCRIPTION	PART #
For 23-later WP XACT 5057 shock with 69 mm reservoir	1313-0255	For WP XPLOR shock with 49 mm reservoir	1313-0257
For WP XACT 5057 shock with standard reservoir	1313-0256		



1314-0801

EXHAUST

LUGGAGE

BIKE STANDS & ACCESSORIES

HANDLEBARS & HAND CONTROLS

FOOTPEGS & FOOT CONTROLS

BODY

GRAPHICS & SEATS

SPROCKETS

CHAINS

BRAKES

WHEELS & ACCESSORIES

SUSPENSION

ELECTRICAL & GAUGES

LIGHTING

ENGINE

FUEL/AIR SYSTEMS

HARDWARE & MERCHANDISING

REAR SHOCK SERVICE KITS

- Include all necessary parts for a complete rear suspension rebuild
- See page 1138 of the 2024 Parts Europe Offroad catalog for the complete line of KYB rear shock service kits

APPLICATIONS

FITS MODEL	PART #	FITS MODEL	PART #
FANTIC		KAWASAKI (CONT)	
XXF 250/450 21-25	1314-0801	KX 250 20-25	1314-0801
XXF 250/450 21-25	1314-0802	KX 450F 09-14	1314-0801
XEF 250/450 21-25	1314-0801	RIEJU	
XEF 250/450 21-25	1314-0802	MR PRO 250/300 21-25	1314-0803
GASGAS		MR RACING 250/300 21-25	1314-0803
EC 250/300 18-20	1314-0803	SHERCO	
HONDA		SE-R 125/250/300 19-25	1314-0822
CRF 450R 09-16	1314-0801	SEF-R 250/300/450/500 19-25	1314-0822
KAWASAKI		SUZUKI	
KX 125/250 99	1314-0109	RM-Z 250 16-25	1314-0801

DIMENSIONS

DIMENSIONS	PART #	DIMENSIONS	PART #
46/16 mm	1314-0109	50/16 mm	1314-0802
46/18 mm	1314-0803	50/16 mm	1314-0801

FITS MODEL	PART #
YAMAHA	
YZ 125/250 06-25	1314-0803
YZ 250F 06-11	1314-0803
YZ 250F 14-23	1314-0801
YZ 250F 24-25	1314-0802
YZ 450F 06-09	1314-0803
YZ 450F 10-23	1314-0801
YZ 450F 24-25	1314-0802
WR 250F 15-25	1314-0801
WR 450F 16-25	1314-0801

DIMENSIONS	PART #
50/18 mm	1314-0822

REAR SHOCK LOCK NUT

- Designed to secure offroad rear shock absorber components
- Provides a secure fit that prevents loosening during intense rides
- Made from high-quality materials



FITS MODEL	PART #	FITS MODEL	PART #
BETA		HONDA (CONT)	
RR 2T 125/200/250/300 23-25	1314-0062	CR 500 91-02	1314-0062
RR 4T 350/390/430/480 23-25	1314-0062	CRF 450 09-16	1314-0062
RX 300 23-25, RX 450 24-25	1314-0062	XR 650 00-07	1314-0062
FANTIC		KAWASAKI	
XX 125/250 20-25	1314-0062	KX 85 25	1314-0062
XXF 250/450 20-25	1314-0062	KX 125 93-08	1314-0062
XE 125 20-25	1314-0062	KX 250 93-08	1314-0062
XE 300 24-25	1314-0062	KX 250F 04-05/20-25	1314-0062
XEF 250 20-25	1314-0062	KX 450F 06-14	1314-0062
XEF 310 24-25	1314-0062	RIEJU	
XEF 450 20-25	1314-0062	MR PRO 250/300 21-25	1314-0062
GASGAS		MR RACING 250/300 21-25	1314-0062
EC 250/300 18-20	1314-0062	MR RANGER 250/300 21-25	1314-0062
Ranger 250/300 19-20	1314-0062	SHERCO	
HONDA		SE-R 125/250/300 19-25	1314-0062
CR 125 91-07	1314-0062	SEF-R 250/300/450/500 19-25	1314-0062
CR 250 91/95-96	1314-0062		

FITS MODEL	PART #
STARK	
Varg (all) 23-25	1314-0062
Varg Enduro (all) 25	1314-0062
SUZUKI	
RM 250 01-03	1314-0062
RM-Z 250 04-06, 16-25	1314-0062
TRIUMPH	
TF 250-X 24-25	1314-0062
TF 450-X 25	1314-0062
YAMAHA	
YZ 80 93-01	1314-0062
YZ 85 02-25	1314-0062
YZ 125 91-25	1314-0062
YZ 250 91-25	1314-0062
YZ 250F 01-25	1314-0062
YZ 426F 00-02	1314-0062
YZ 450F 03-25	1314-0062

REAR SHOCK PISTON O-RING

- Dimensions: 50 mm
- See page 1136 of the 2024 Parts Europe Offroad catalog for the complete line of KYB rear shock piston o-rings



APPLICATIONS

FITS MODEL	PART #	FITS MODEL	PART #
BETA		KAWASAKI (CONT)	
RX 450 24-25	1314-0221	KX 450F 09-14	1314-0221
FANTIC		SHERCO	
XXF 250/450 20-25	1314-0221	SE-R 125/250/300 19-25	1314-0221
XEF 250/450 20-25	1314-0221	SEF-R 250/300/450/500 19-25	1314-0221
XEF 310 24-25	1314-0221	STARK	
HONDA		Varg 23-25	1314-0221
CR 450R 09-16	1314-0221	Varg Enduro 25	1314-0221
KAWASAKI		SUZUKI	
KX 250 20-25	1314-0221	RM-Z250 16-25	1314-0221

FITS MODEL	PART #
TRIUMPH	
TF 250-X 24-25	1314-0221
TF 450-X 25	1314-0221
YAMAHA	
YZ 250F 14-25	1314-0221
YZ 450F 10-25	1314-0221
WR 250F 15-25	1314-0221
WR 450F 16-25	1314-0221

REAR SHOCK BUMP RUBBERS

- See page 1139 of the 2024 Parts Europe Offroad catalog for the complete line of KYB rear shock bump rubbers



1314-0800

APPLICATIONS

FITS MODEL	PART #	FITS MODEL	PART #	FITS MODEL	PART #
GASGAS		KAWASAKI		YAMAHA	
Ranger 250/300 19-20	1314-0800	KX 125/250 91-00	1314-0800	YZ 125/250 91-00	1314-0800
HONDA		KX 250 21-25	1314-0420	YZ 250F 14-25	1314-0420
CR 125R 93-00	1314-0800	KX 500 91-04	1314-0800	YZ 426F 00	1314-0800
CR 250R 95-96	1314-0800	RIEJU		YZ 450F 10-25	1314-0420
CR 500R 95-02	1314-0800	MR RANGER 250/300 21-25	1314-0800	WR 250F 20-25	1314-0420
XR 650R 00-07	1314-0800			WR 450F 19-25	1314-0420

DIMENSIONS

DIMENSIONS	PART #
16 mm	1314-0420
16 mm	1314-0800



LOWER SHOCK BEARING KIT

- Kit includes the shock bearing, seals, spacers, and pins (if required) to rebuild the shock link
- Premium design and construction stands up to tough conditions
- Older bearing and seal designs updated to the latest in bearing technology
- See pages 1143-1145 of the 2024 Parts Europe Offroad catalog for the complete line of Moose Racing upper and lower shock bearing kits

FITS MODEL	PART #	FITS MODEL	PART #	FITS MODEL	PART #
GASGAS		GASGAS (CONT)		GASGAS (CONT)	
MC 125 24-25	1313-0250	MC 250F 24-25	1313-0250	EC 300 24-25	1313-0250
MC 250 24-25	1313-0250	MC 350F 24-25	1313-0250	HUSQVARNA	
MC 250F Factory Edition 23	1313-0250	EC 250 24-25	1313-0250	TE 300 24-25	1313-0250



LOWER SHOCK BEARING KIT

- Each premium kit contains all elements required for a full OEM-quality service of your shock bearing
- Our dedicated offroad design of needle bearings, collars, pins and dust seals are specifically manufactured in order to reach the stringent OEM quality requirements, in terms of materials, dimension tolerances, hardness and surface roughness
- See pages 1145-1147 of the 2024 Parts Europe Offroad catalog for Factory Links' complete line of shock bearing kits

FITS MODEL	PART #	FITS MODEL	PART #	FITS MODEL	PART #
GASGAS		HUSQVARNA		KTM	
MC 125/250/250F/350F/450F 25	1313-0259	TC 125/250 25	1313-0259	SX 125/250/300 25	1313-0259
		FC 250/350/450 25	1313-0259	SX-F 250/350/450 25	1313-0259



LINKAGE BEARING KITS

- Each kit includes the lower shock bearing, all the shafts, seals and spacers in the link, link arm and lower shock mount
- 52100 bearing steel and hard-plated spacers resist wear and rust
- See pages 1155-1156 of the 2024 Parts Europe Offroad catalog for the complete line of Moose Racing linkage bearing kits

FITS MODEL	PART #	FITS MODEL	PART #	FITS MODEL	PART #
HONDA		HONDA (CONT)		HONDA (CONT)	
CRF 80F 04-13	A27-1091	XR 80R 85-03	A27-1091	XR 100R 85-00	A27-1091



LINKAGE BEARING REBUILD KITS

- Each premium kit contains all elements required for a full OEM-quality service of your linkage
- A dedicated offroad design of needle bearings, collars, pins and dust seals is specifically manufactured in order to reach the stringent OEM quality requirements, in terms of materials, dimension tolerances, hardness and surface roughness

FITS MODEL	PART #	FITS MODEL	PART #	FITS MODEL	PART #
GASGAS		HUSQVARNA		KAWASAKI (CONT)	
MC 125/250/250F/350F/450F 25	1302-0872	TC 125/250 25	1302-0872	KX 450 24-25	1302-0873
HONDA		FC 250/350/450 25	1302-0872	KTM	
CRF 250R/RWE 25	1302-0871	KAWASAKI		SX 125/250/300 25	1302-0872
CRF 450R/RWE 25	1302-0871	KX 250 25	1302-0873	SX-F 250/350/450 25	1302-0872



- Includes lower shock absorber service kit
- See pages 1156-1157 of the 2024 Parts Europe Offroad catalog for Factory Links' complete line of linkage bearing rebuild kits



EXHAUST

LUGGAGE

BIKE STANDS & ACCESSORIES

HANDLEBARS & HAND CONTROLS

FOOTPEGS & FOOT CONTROLS

BODY

GRAPHICS & SEATS

SPROCKETS

CHAINS

BRAKES

WHEELS & ACCESSORIES

SUSPENSION

ELECTRICAL & GAUGES

LIGHTING

ENGINE

FUEL/AIR SYSTEMS

HARDWARE & MERCHANDISING



2113-0949

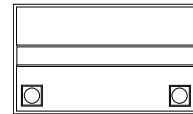

HIGH PERFORMANCE LITHIUM MAX BATTERIES

- Crafted to exceed the exacting standards of modern vehicles including off-road bikes, V-Twins and ATV/UTV vehicles
- Features robust brass terminals and larger polymer cells
- Delivers unrivaled performance with enhanced CCA and capacity
- Engineered to meet the latest electrical standards
- Tailored to seamlessly integrate into present-day motorcycles as original equipment manufacturer fittings
- Ready to use: just plug-and-play
- Fast charging
- Multi-positioning mounting and light weight
- Very safe and environmental friendly
- Extensive cycle life: over 2.000 cycles
- Very low self-discharge
- Cold temperature performance
- Heat temperature resistance up to 230 °C
- Waterproof design

YUASA REFERENCE #	POWER (WH)	CAPACITY AH (10-HR)	COLD CRANKING AMPS	LENGTH (MM)	WIDTH (MM)	HEIGHT (MM)	APPROX. WEIGHT (KG)	TERMINAL CONFIGURATION	PART #
YB4L-B, YTX4L+, YTX5L, YTZ5S, YTZ6S, YB7C-A, YB7L-B2, YTX7L, YTZ7S, YTZ7V, YTZ8V	36	3	180	114	70	85	0,8	-	+ 2113-0938
Y50-N18L-A/A2/A3/AT, YB18L-A, YTX20L, YTX20HL, YTX24HL	180	15	750	175	87	155	2,7	-	+ 2113-0949
YB30CL-B, YB30L-B, YIX30L, YIX30HL, 12N24-3A, 52515, 53030	216	18	900	166	127	175	3,0	-	+ 2113-0950

FITS MODEL	PART #	FITS MODEL	PART #	FITS MODEL	PART #
AJP		BETA (CONT)		FANTIC (CONT)	
SPR 125 Enduro 19-25	2113-0938	RR X-Pro 2T 300 25	2113-0938	XEF 250 2T 20-21	2113-0938
SPR 240 Enduro 19-25	2113-0938	RR X-Pro 4T 350 25	2113-0938	XEF 250 4T 20-23	2113-0938
SPR 250 Enduro 19-25	2113-0938	RR X-Pro 4T 390 25	2113-0938	XEF 250 Trail 2T 20-21	2113-0938
SPR 310 Enduro 19-25	2113-0938	RR X-Pro 4T 430 25	2113-0938	XEF 250 Trail 4T 20-25	2113-0938
SPR 510 Enduro 19-25	2113-0938	RR X-Pro 4T 480 25	2113-0938	XEF 450 21-25	2113-0938
APRILIA		Xtrainer 250 2T 19-20	2113-0938	XEF 450 Rally 23-25	2113-0938
AE 50 Pegaso 92-96	2113-0938	Xtrainer 300 2T 15-20	2113-0938	XMF 125 Competition 21-23	2113-0938
ETX 50 87	2113-0938	BMW		XMF 125 Performance 21-23	2113-0938
ETX 125 99-02	2113-0938	G 450X 08-11	2113-0938	50E TX 180E 2T Regolarita Casa 12-15	2113-0938
MX 50 03-05	2113-0938	CAGIVA		50ER TX 180ER 2T Regolarita Competizione 12-15	2113-0938
MX 125 03-07	2113-0938	K3 50 91-93	2113-0938	50ES TX 180ES 2T Regolarita Scuderia 12-15	2113-0938
RX 50 91-20	2113-0938	125W8 92-96	2113-0938	50M TX 180M 2T Motard Casa 12-15	2113-0938
RX 50C 95-04	2113-0938	K7 125 89-92	2113-0938	50MR TX 180MR 2T Motard Competizione 12-15	2113-0938
RX 125 00-12/21-25	2113-0938	DERBI		Koala 50 87	2113-0938
RX 125E 93-99	2113-0938	50 Senda-R 96-02	2113-0938	Koala 80 87	2113-0938
RX 125IE 18-20	2113-0938	50R Senda RT 00-01	2113-0938	GARELLI	
RX 125R 92-95	2113-0938	50R Senda Racer 01-03	2113-0938	Sahel 50 91	2113-0938
SX 125 08-13/21-25	2113-0938	50R Senda X Racer 04-11	2113-0938	Tiger 50XLE 86	2113-0938
SX 125IE 18-20	2113-0938	50R Senda X-Treme 02-18	2113-0938	GASGAS	
BETA		50R Senda X-Treme 19-21	2113-0938	MC 250F 21-23	2113-0938
RE 125 4T 09-16	2113-0938	DRD 50R Senda Racing 06-13	2113-0938	MC 250F Factory Edition 23	2113-0938
RR 125 2T 09-20	2113-0938	DRD 50R Senda Pro 02-03	2113-0938	MC 350F 21-23	2113-0938
RR 200 2T 19-20	2113-0938	DRD 50R Senda Pro 07-16	2113-0938	MC 450F 21-23	2113-0938
RR 250 4T 05-09	2113-0938	DRD 50R Senda Pro 05-06	2113-0938	MC 450F Factory Edition 23	2113-0938
RR/Racing 250 2T 13-24	2113-0938	DRD 50R Limited Racing 07-08	2113-0938	EC 50 05-07	2113-0938
RR/Racing 300 2T 13-24	2113-0938	DRD 50R Limited 04-05	2113-0938	EC 50 Rookie 01-05	2113-0938
RR 350 4T 11-12	2113-0938	DRD 50R Black Devil Edition 04-05	2113-0938	EC 200 13-17	2113-0938
RR/Racing 350 4T 13-24	2113-0938	125R Senda 04-05	2113-0938	EC 200ER 14-17	2113-0938
RR/Racing 390 4T 15-24	2113-0938	125R Senda Baja 06-12	2113-0938	EC 250 12-17	2113-0938
RR 400 4T 05-14	2113-0938	DRD 125R Senda 10-13	2113-0938	EC 250 21-23	2113-0938
RR/Racing 430 4T 15-24	2113-0938	DRD 125SM Senda 09-15	2113-0938	EC 250E4 18-20	2113-0938
RR 450 4T 05-12	2113-0938	Variant Sport 50 2T 12	2113-0938	EC 250E4 EnduroGP 18-20	2113-0938
RR/Racing 450 4T 13-14	2113-0938	Terra Adventure 125 07-14	2113-0938	EC 250E4 Six Days 19-20	2113-0938
RR/Racing 480 4T 15-25	2113-0938	FANTIC		EC 250ER 14-17	2113-0938
RR 498 4T 12-14	2113-0938	XXF 250 21-23	2113-0938	EC 250F 10-15/21-23	2113-0938
RR 520 4T 10-12	2113-0938	XXF 450 21-23	2113-0938	EC 250F Cami 14-15	2113-0938
RR 525 4T 05-09	2113-0938	XE 125 20-23	2113-0938		
RR Cross Country 450 4T 12	2113-0938	XEF 125 Competition 21-23	2113-0938		
RR X-Pro 2T 200 25	2113-0938	XEF 125 Performance 21-23	2113-0938		

DISCLAIMER: SEE PAGE 4 FOR IMPORTANT INFORMATION REGARDING CERTAIN WARRANTY AND EMISSION CONTROL REGULATION COMPLIANCE AND NOISE REGULATION INFORMATION.



HIGH PERFORMANCE LITHIUM MAX BATTERIES (CONT)

FITS MODEL	PART #
GASGAS (CONT)	
EC 300 12-15	2113-0938
EC 300 21-23	2113-0938
EC 300E4 18	2113-0938
EC 300E4 EnduroGP 18	2113-0938
EC 300E4 Six Days 19-20	2113-0938
EC 300ER 14-17	2113-0938
EC 300F 4T 13-15	2113-0938
EC 350F 21-23	2113-0938
EC 400FSE 02	2113-0938
EC 450F 4T 13-15	2113-0938
EC 450FSE Enduro 03-09	2113-0938
EC 450FSR 05-09	2113-0938
EC 515FSE 05-09	2113-0938
EC 515FSR 05-09	2113-0938
Pampera 250 96-04	2113-0938
Pampera 370 96-97	2113-0938
GENERIC	
SM 50 Trigger Competition 08-11	2113-0938
SM 50 Trigger 06-13	2113-0938
X 50 Trigger 06-13	2113-0938
GILERA	
GSM 50 00-03	2113-0938
H@K 50 00-02	2113-0938
RC 50 Top Rally 90	2113-0938
RCR 50 Enduro 06-19	2113-0938
SMT 50 Supermotard 03-21	2113-0938
Zulu 50 01-02	2113-0938
HONDA	
CRF 110F 13-20	2113-0938
CRF 125F 14-20	2113-0938
CRF 125FB BW 20	2113-0938
CRF 150F 06-17	2113-0938
CRF 230F 04-20	2113-0938
CRF 230L 08-10	2113-0938
CRF 230M 09-10	2113-0938
CRF 250L 12-15	2113-0938
CRF 250LA 17-20	2113-0938
CRF 250M 13-16	2113-0938
CRF 250R 18-25	2113-0938
CRF 250RL Rally 17	2113-0938
CRF 250RLA Rally 17-20	2113-0938
CRF 250RX 19-25	2113-0938
CRF 250X 04-18	2113-0938
CRF 300L 21-25	2113-0938
CRF 450L 19-25	2113-0938
CRF 450RL/RLM/X 21-25	2113-0938
CRF 450R 19-25	2113-0938
CRF 450RM/RW 21-25	2113-0938
CRF 450RX 19-25	2113-0938
CRF 450X 05-18	2113-0938
NX 250 87-93	2113-0938
NX 2502 90-93	2113-0938
XL 230 02	2113-0938
XR 125L 03-08	2113-0938
HUSABERG	
TE 250 2T 11-14	2113-0938
TE 300 2T 11-14	2113-0938
FE 250E 4T 13-14	2113-0938
FE 350E 4T 14	2113-0938
FE 400 00-02	2113-0938
FE 450 08-14	2113-0938
FE 450E 03-08	2113-0938
FE 501 00-02	2113-0938
FE 501 4T 13-14	2113-0938
FE 501E 03-04	2113-0938
FE 550E 04-08	2113-0938
FE 600 Enduro 00-03	2113-0938
FE 650E 04-05	2113-0938
HUSQVARNA	
TC 125 23-25	2113-0938
TC 125 Heritage 23-25	2113-0938
TC 250 23-25	2113-0938
TC 250 Heritage 23-25	2113-0938

FITS MODEL	PART #
HUSQVARNA (CONT)	
TC 450 02	2113-0938
FC 250 14-15/19-25	2113-0938
FC 250 Heritage 23-25	2113-0938
FC 350 14-15/18-25	2113-0938
FC 350 Heritage 23-25	2113-0938
FC 450 14-15/18-25	2113-0938
FC 450 Heritage 23-25	2113-0938
FC 450 Rockstar Edition 23-25	2113-0938
TE 150 18-25	2113-0938
TE 150 Heritage 23-25	2113-0938
TE 250 14-25	2113-0938
TE 250 Heritage 23-25	2113-0938
TE 300 14-25	2113-0938
TE 300 Heritage 23-25	2113-0938
TE 410 97-99	2113-0938
TE 450 02-10	2113-0938
TE 510 04-10	2113-0938
FE 250 14-25	2113-0938
FE 250 Heritage 23-25	2113-0938
FE 350 14-25	2113-0938
FE 350 Heritage 23-25	2113-0938
FE 450 14-25	2113-0938
FE 450 Heritage 23-25	2113-0938
FE 501 14-25	2113-0938
FE 501 Heritage 23-25	2113-0938
KAWASAKI	
KX 250 23-25	2113-0938
KX 450 19-25	2113-0938
KLX 110 10-25	2113-0938
KLX 125 D-Tracker 10-14	2113-0938
KLX 125 03-16	2113-0938
KLX 250 D-Tracker 98-03	2113-0938
KLX 250 94-19	2113-0938
KLX 250S 06-14	2113-0938
KLX 450R 07-22	2113-0938
KMX 125 86-02	2113-0938
KMX 200 88-92	2113-0938
KLE 250 95-01	2113-0938
KL 250 KLR 250 85-05	2113-0938
KL 250 Super Sherpa 00-10	2113-0938
KEEWAY	
X-Ray 50 Supermoto 07-09	2113-0938
TX 125SM 10-14	2113-0938
TX 200 13-14	2113-0938
KTM	
SX-F 250 12-15/18-25	2113-0938
SX-F 350 10-15/18-25	2113-0938
SX-F 450 07-15/18-25	2113-0938
SX-F 450 Cairoli 20	2113-0938
SX-F 450 Herlings Replica 19-20	2113-0938
SX-F 505 07	2113-0938
EXC 150 20-22	2113-0938
EXC 200 13-16	2113-0938
EXC 250 11-22	2113-0938
EXC 250 E-Starter 10	2113-0938
EXC 250 Factory 05	2113-0938
EXC 250 Racing 01-06	2113-0938
EXC 250 Racing Six Days 03	2113-0938
EXC 250 Six Days 11-16	2113-0938
EXC 250 Six Days 18-25	2113-0938
EXC 300 08-22	2113-0938
EXC 300 Factory Edition 11	2113-0938
EXC 300 Erzbergrodeo 20-22	2113-0938
EXC 300 Six Days 09-22	2113-0938
EXC 400 09-11	2113-0938
EXC 400 Factory Edition 11	2113-0938
EXC 400 Factory Racing 05-07	2113-0938
EXC 400 Racing 00-07	2113-0938
EXC 400 Racing Six Days 01-03	2113-0938
EXC 450 06-16	2113-0938
EXC 450 Champion Edition 10	2113-0938
EXC 450 Factory 05	2113-0938
EXC 450 Factory Racing 07	2113-0938

FITS MODEL	PART #
KTM (CONT)	
EXC 450 Racing 03-07	2113-0938
EXC 450 Racing Six Days 04-07	2113-0938
EXC 450 Six Days 09-16	2113-0938
EXC 500 12-16	2113-0938
EXC 500 Six Days 12-16	2113-0938
EXC 520 Racing 00-02	2113-0938
EXC 520 Racing Six Days 01-02	2113-0938
EXC 525 Factory 05	2113-0938
EXC 525 Factory Racing 07	2113-0938
EXC 525 Racing 03-07	2113-0938
EXC 525 Racing Six Days 03-07	2113-0938
EXC 530 09-11	2113-0938
EXC 530 Factory Edition 11	2113-0938
EXC 530 Six Days 09-12	2113-0938
EXC-E 300 07	2113-0938
EXC-E 300 Six Days 08-11	2113-0938
EXC-F 250 06-22	2113-0938
EXC-F 250 Champion Edition 10	2113-0938
EXC-F 250 Factory Edition 11	2113-0938
EXC-F 250 Factory Edition 15	2113-0938
EXC-F 250 Racing 02-06	2113-0938
EXC-F 250 Six Days 07-25	2113-0938
EXC-F 350 11-25	2113-0938
EXC-F 350 Six Days 12-25	2113-0938
EXC-F 450 17-25	2113-0938
EXC-F 450 Six Days 17-25	2113-0938
EXC-F 500 17-25	2113-0938
EXC-F 500 Six Days 17-25	2113-0938
EXC-GS 200 02	2113-0938
EXC-R 450 08	2113-0938
EXC-R 450 Six Days 08	2113-0938
EXC-R 530 08	2113-0938
EXC-R 530 Six Days 08	2113-0938
EXE 125 00-01	2113-0938
Freeride 250F 18-20	2113-0938
Freeride 250R 14-17	2113-0938
Freeride 350F 12-16	2113-0938
MXC 525 Desert Racing 03-05	2113-0938
MALAGUTI	
XTM 50 03-11	2113-0938
Enduro Dune 50 87	2113-0938
Grizzly 50RCW4 01-07	2113-0938
Grizzly 50RCX 10 90-00	2113-0938
Grizzly 50RCX 12 90-00	2113-0938
Super Motard XSM 50 03-11	2113-0938
RIEJU	
Marathon 125AC 09-20	2113-0938
Marathon Pro 125LC 09-20	2113-0938
Marathon Pro Competizione 125LC 11-14	2113-0938
Marathon Pro Supermotard 125LC 09-20	2113-0938
Marathon Supermotard 125AC 10-20	2113-0938
MR RACING 250 21-25	2113-0938
MR RACING 300 21-25	2113-0938
MR PRO 250 21-25	2113-0938
MR PRO 300 21-25	2113-0938
MR RANGER 300 21-25	2113-0938
MR Six Days 300 21-25	2113-0938
SHERCO	
SC-R 125 Cross Country 2T 19-20	2113-0938
SC-R 250 Cross Country 2T 19-20	2113-0938
SC-R 300 Cross Country 2T 19-20	2113-0938
SCF-R 250 Cross Country 4T 19-20	2113-0938
SCF-R 300 Cross Country 4T 19-20	2113-0938
SCF-R 450 Cross Country 19-20	2113-0938
SCF-R 500 Cross Country 19-20	2113-0938
SE 125 Factory 2T 21-23	2113-0938
SE 125 Racing 2T 21-22	2113-0938
SE 250 Enduro 2T 14-18	2113-0938
SE 250 Factory 2T 21-25	2113-0938
SE 250 Racing 2T 21-25	2113-0938
SE 250F Enduro 4T 12-13	2113-0938
SE 300 Enduro 2T 14-18	2113-0938
SE 300 Factory 2T 21-25	2113-0938

EXHAUST

LUGGAGE

BIKE STANDS & ACCESSORIES

HANDLEBARS & HAND CONTROLS

FOOTPEGS & FOOT CONTROLS

BODY

GRAPHICS & SEATS

SPROCKETS

CHAINS

BRAKES

WHEELS & ACCESSORIES

SUSPENSION

ELECTRICAL & GAUGES

LIGHTING

ENGINE

FUEL/AIR SYSTEMS

HARDWARE & MERCHANDISING

HIGH PERFORMANCE LITHIUM MAX BATTERIES continued on next page.

DISCLAIMER: SEE PAGE 4 FOR IMPORTANT INFORMATION REGARDING CERTAIN WARRANTY AND EMISSION CONTROL REGULATION COMPLIANCE AND NOISE REGULATION INFORMATION.



HIGH PERFORMANCE LITHIUM MAX BATTERIES (CONT)

	FITS MODEL	PART #	FITS MODEL	PART #	FITS MODEL	PART #	
EXHAUST	SHERCO (CONT)		SUZUKI (CONT)		TM (CONT)		
	SE 300 Racing 2T 21-25	2113-0938	DR 250R 98-00	2113-0938	EN 450 Fi 11-16	2113-0938	
LUGGAGE	SE 300F Enduro 4T 12-13	2113-0938	DR 250S 82-87/90-92	2113-0938	EN 450 Fi 17-18	2113-0938	
	SE-R 125 Cross Country 2T 19-20	2113-0938	DR 250SE 93-95	2113-0938	EN 530 F 04-16	2113-0938	
	SE-R 125 Enduro Factory 2T 18-20	2113-0938	DR 350S 90-93	2113-0938	YAMAHA		
BIKE STANDS & ACCESSORIES	SE-R 125 Enduro Racing 2T 18-20	2113-0938	DR 350SE 94-99	2113-0938	YZ 250F 19-25	2113-0938	
	SE-R 250 Enduro Factory 2T 17-21	2113-0938	DR 650R 92-93	2113-0938	YZ 450F 18-23	2113-0938	
	SE-R 250 Enduro Racing 2T 14-20	2113-0938	DR-Z 250 01-07	2113-0938	TTR 125 00-05	2113-0938	
	SE-R 300 Enduro Factory 2T 17-21	2113-0938	RMX 450Z 10-17	2113-0938	TTR 125E 04-09	2113-0938	
	SE-R 300 Enduro Racing 2T 14-21	2113-0938	TS 50W 86	2113-0938	TTR 125LW 00-16	2113-0938	
	SE-R 300 Enduro Factory 2T 21-25	2113-0938	TS 50XK 84-02	2113-0938	TTR 125LWE 03-17	2113-0938	
	SE-RS 125 Factory 4T 23-25	2113-0938	TS 80X/RH 84-88	2113-0938	TTR 230 05-06	2113-0938	
	SEF 250 Enduro 4T 14-18	2113-0938	TS 125ER 82	2113-0938	DT 50R 03-12	2113-0938	
	SEF 300 Enduro 4T 14-18	2113-0938	TS 125R 90-96	2113-0938	DT 125E 74-79	2113-0938	
	SEF 450 15-18	2113-0938	TS 125X 84	2113-0938	DT 125RE 04-07	2113-0938	
HANDLEBARS & HAND CONTROLS	SEF-R 250 Enduro Factory 4T 17-25	2113-0938	TS 125XU 86-90	2113-0938	DT 125X 05-06	2113-0938	
	SEF-R 250 Enduro Racing 4T 14-20	2113-0938	TS 200R 89-94	2113-0938	TW 125 02-06	2113-0938	
	SEF-R 300 Enduro Factory 4T 17-21	2113-0938	TS 250X 84-89	2113-0938	TW 125 99-01	2113-0938	
	SEF-R 300 Enduro Racing 4T 14-21	2113-0938	SWM		TW 200 89-94	2113-0938	
	SEF-R 450 Enduro Factory 17-25	2113-0938	RS 300R 15-25	2113-0938	TW 225E 03	2113-0938	
	SEF-R 450 Enduro Racing 15-25	2113-0938	RS 500R 15-25	2113-0938	WR 250F 03-07	2113-0938	
	SEF-R 500 Enduro Factory 19-25	2113-0938	SM 125R 22-25	2113-0938	WR 250F 08-23	2113-0938	
	SEF-R 500 Enduro Racing 19-20	2113-0938	SM 500R 16-25	2113-0938	WR 250R 08-16	2113-0938	
	SM-RS 125 Blackmoon 4T 23-25	2113-0938	TM		WR 450F 03-22	2113-0938	
	SM-RS 125 Factory 4T 23-25	2113-0938	MX 530 F 05-15	2113-0938	XT 125R 05-11	2113-0938	
FOOTPEGS & FOOT CONTROLS	SUZUKI		EN 250 Enduro 10-17	2113-0938	XT 125X 05-11	2113-0938	
	DR 125S 82-94	2113-0938	EN 250 F 4T Enduro 09-10	2113-0938	XT 225 97-01	2113-0938	
	DR 125SE 94-01	2113-0938	EN 250 Fi 4T Enduro 17	2113-0938	XT 225 Serrow 86-93	2113-0938	
	DR 125SM 08-13	2113-0938	EN 250 Fi 4T Enduro 11-16	2113-0938	XT 225W Serrow 93-98	2113-0938	
	DR 200 86-89	2113-0938	EN 300 10-17	2113-0938	XT 250X 06-08	2113-0938	
	DR 200SE 93-13	2113-0938	EN 300 Fi 4T Enduro 17	2113-0938	XTZ 700 Tenere 23-24	2113-0938	
	DR 250 90-93	2113-0938	EN 450 F 03-10	2113-0938	XTZ 700D Tenere World Raid 23-24	2113-0938	
	BODY	SUZUKI					
		DR 125S 82-94	2113-0938				
		DR 125SE 94-01	2113-0938				
DR 125SM 08-13		2113-0938					
DR 200 86-89		2113-0938					
DR 200SE 93-13		2113-0938					
DR 250 90-93		2113-0938					
GRAPHICS & SEATS							
SPROCKETS							
CHAINS							
BRAKES							
WHEELS & ACCESSORIES							
SUSPENSION							
ELECTRICAL & GAUGES							
LIGHTING							
ENGINE							
FUEL/AIR SYSTEMS							
HARDWARE & MERCHANDISING							



SLA FACTORY-ACTIVATED AGM MAINTENANCE-FREE BATTERIES

- AGM construction (Absorbed Glass Material)
- VRLA battery (Valve Regulated Lead Acid)
- Sealed and factory-activated
- Spillproof design
- Multi-positional fitment
- Ready and easy to use
- Increased power and extended life
- Extreme vibration resistance
- See page 175 of the 2024 Parts Europe Offroad catalog for the complete line of BS Battery SLA Factory-Activated AGM maintenance-free batteries



2113-0966



2113-0964

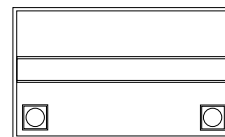

YUASA REFERENCE #	CAPACITY AH (10-HR)	CAPACITY AH (20-HR)	COLD CRANKING AMPS @-18 °C	LENGTH (MM)	WIDTH (MM)	HEIGHT (MM)	APPROX. WEIGHT (KG)	TERMINAL CONFIGURATION	PART #
YBTR4A-5	2,3	2,4	35	113	48	85	0,96	++ (both terminals on left side)	2113-0966
YB3L-A/B	3	3,2	35	98	56	110	1,20	-	2113-0965
12N5.5-4A	5	5,8	70	135	60	130	2,31	+	2113-0964

FITS MODEL	PART #	FITS MODEL	PART #	FITS MODEL	PART #
CAGIVA		HONDA (CONT)		HONDA (CONT)	
T4R 87	2113-0965	XL 250R 82-87	2113-0965	XL 600R 83-87	2113-0965
HONDA		XL 350R 84-85	2113-0965	YAMAHA	
XL 200R 83-84	2113-0965	XL 500R 82	2113-0965	XT 250 84	2113-0965
				XT 350 85-00	2113-0965

YUASA BATTERY SPARE PARTS

- Bolts and nuts sold in packs of five sets of two each

DESCRIPTION	PART #
Bolt/nut set (2 ea.) 6 x 11 mm (5 pk.)	2113-0079



DISCLAIMER: SEE PAGE 4 FOR IMPORTANT INFORMATION REGARDING CERTAIN WARRANTY AND EMISSION CONTROL REGULATION COMPLIANCE AND NOISE REGULATION INFORMATION.



BS 30 SMART BATTERY CHARGERS/MAINTAINERS

- Easy to use: connect and forget
- Includes nine stages of charge to enhance the performance of all your powersports batteries
- Designed for batteries up to 60Ah
- Auto detect lead acid or lithium technology
- Adaptable charging algorithm for lead acid and lithium (LiFePO4)
- Safe: connection spark free, reverse polarity, short circuit and internal overheat protection
- 12V smart battery charger and maintainer rated at 3A
- Includes one clamp set and one fused ring terminal set
- Multiaxis hook



DESCRIPTION	PART #
EU plug	3807-0587
UK plug	3807-0706



BS 10 SMART BATTERY CHARGERS/MAINTAINERS

- Ideal for maintenance
- Very safe and compact
- Easy to use: connect and forget
- Includes nine stages of charge to enhance the performance of all your powersports batteries
- Designed for batteries up to 20Ah
- Auto detect lead acid or lithium technology
- Adaptable charging algorithm for lead acid and lithium (LiFePO4)
- Safe: connection spark free, reverse polarity, short circuit and internal overheat protection
- 6V and 12V smart battery charger and maintainer rated at 1A
- 6V and 12V manual switch selection
- Includes one clamp set and one fused ring terminal set



DESCRIPTION	PART #
EU plug	3807-0464
UK plug	3807-0696



FLEECE WIRE HARNESS TAPE

- Cloth wiring tape
- Useful for noise dampening in wiring looms
- Highly abrasion resistant
- 25.4 mm (1") wide x 25 m (82') long roll
- Sold each

DESCRIPTION	PART #
Fleece wire harness tape	2130-0374



DISCLAIMER: SEE PAGE 4 FOR IMPORTANT INFORMATION REGARDING CERTAIN WARRANTY AND EMISSION CONTROL REGULATION COMPLIANCE AND NOISE REGULATION INFORMATION.

EXHAUST

LUGGAGE

BIKE STANDS & ACCESSORIES

HANDLEBARS & HAND CONTROLS

FOOTPEGS & FOOT CONTROLS

BODY

GRAPHICS & SEATS

SPROCKETS

CHAINS

BRAKES

WHEELS & ACCESSORIES

SUSPENSION

ELECTRICAL & GAUGES

LIGHTING

ENGINE

FUEL/AIR SYSTEMS

HARDWARE & MERCHANDISING

EXHAUST

LUGGAGE

BIKE STANDS & ACCESSORIES

HANDLEBARS & HAND CONTROLS

FOOTPEGS & FOOT CONTROLS

BODY

GRAPHICS & SEATS

SPROCKETS

CHAINS

BRAKES

WHEELS & ACCESSORIES

SUSPENSION

ELECTRICAL & GAUGES

LIGHTING

ENGINE

FUEL/AIR SYSTEMS

HARDWARE & MERCHANDISING



SPARK PLUG RESISTOR COVERS

- Replacement cap for your spark plug
- Waterproof
- 5K-ohms resistance
- Allowable wire diameter 7 to 8 mm



2104-0418



2104-0426

DESCRIPTION	OEM #	PART #
90° ELBOW TYPE		
10/12 mm adaptable thread size, terminal stud, black plastic	8060/8070/LD05FLD05F9	2104-0418
14 mm adaptable thread size, terminal nut, black plastic	8031/8020/LB05E/LB05EP	2104-0415
14 mm adaptable thread size, terminal stud, black plastic	8051/8030/LB05F/LB05FP	2104-0417
14 mm adaptable thread size, terminal nut, special design, black plastic	8744/LB05EZ	2104-0423
102° ELBOW TYPE		
10/12 mm adaptable thread size, terminal stud, black plastic	8072/8641/XB05F/XB05FP	2104-0419
10/12 mm adaptable thread size, terminal nut, black plastic	LD05EH/92248	2104-0440
14 mm adaptable thread size, terminal nut, black plastic	8031/8020	2104-0441
14 mm adaptable thread size, terminal stud, black plastic	8062/8435/XB05F/XB05FP	2104-0421
120° ELBOW TYPE SHORT		
14 mm adaptable thread size, terminal stud, black plastic	8082/8448/8162/YB05F/YB05FP/YB05FP	2104-0426
120° ELBOW TYPE SHORT		
10/12 mm adaptable thread size, terminal stud, black plastic	8052/8429/VB05F/VB05FP	2104-0416
10/12 mm adaptable thread size, terminal nut, black rubber	VD05EMH/7744	2104-0443
14 mm adaptable thread size, terminal stud, black plastic	8032/8413/VB05F/VB05FP	2104-0420
STRAIGHT TYPE		
10/12 mm adaptable thread size, terminal stud, black plastic	8022/8325/SD05F/SD05F	2104-0422
14 mm adaptable thread size, terminal nut, black plastic	SB05E/8374	2104-0442
14 mm adaptable thread size, terminal stud, black plastic	8080/8386/SB05F	2104-0425
T TYPE		
10/12 mm adaptable thread size, terminal nut, black rubber	-	2104-0445
14 mm adaptable thread size, terminal nut, black plastic	8636/TB05EMA	2104-0414
14 mm adaptable thread size, terminal nut, silicone rubber body, rubber sheathed special design, red color	8955/B05EM	2104-0424



SPARK PLUG RESISTOR COVERS

- Replacement cap for your spark plug
- Waterproof
- 5K-ohms resistance
- Allowable wire diameter 7 mm to 8 mm



2104-0434

2104-0437

DESCRIPTION	NGK/OEM #	PART #
90° ELBOW TYPE		
10/12 mm adaptable thread size, terminal nut, black plastic	LD05EH/92248	2104-0434
14 mm adaptable thread size, terminal nut, black plastic	LB05EH/8334	2104-0435
120° ELBOW TYPE		
10/12 mm adaptable thread size, terminal nut, black rubber	VD05EMH/7744	2104-0437
STRAIGHT TYPE		
14 mm adaptable thread size, terminal nut, black plastic	SB05E/8374	2104-0436



WIRELESS VIBRATION SENSITIVE HOUR METER

- Enhance your motorcycle adventures
- Accurately tracks engine running hours, offering valuable data for maintenance planning and performance assessment
- Simple to install using the provided adhesive
- Detects engine operation by interpreting and distinguishing frame vibrations
- Lock Mode feature allows you to pause hour counting; helpful during maintenance and transportation to avoid false readings
- Shock-resistant and waterproof design
- Perfect for extreme conditions, ensuring your bike performs at its best in any situation
- Sensitivity adjustment
- Total and partial counter
- Water-resistant IP67 certified



DESCRIPTION	PART #
Wireless vibration sensitive hour meter	2212-0904

DISCLAIMER: SEE PAGE 4 FOR IMPORTANT INFORMATION REGARDING CERTAIN WARRANTY AND EMISSION CONTROL REGULATION COMPLIANCE AND NOISE REGULATION INFORMATION.



REGULATORS/RECTIFIERS

- Replacement-style rectifier/regulator
- Select models have a high-performance, heavy-duty Hot Shot series version made with a special Mosfet technology for cooler running (as noted)
- See page 1216 of the 2024 Parts Europe Offroad catalog for the complete line of Rick's Motorsport Regulator/Rectifiers

FITS MODEL	PART #
APRILIA	
RXV 450 05-12	2112-1786¹
RXV 550 05-12	2112-1786¹
SXV 450 05-12	2112-1786¹
SXV 550 05-12	2112-1786¹

FITS MODEL	PART #
HUSQVARNA	
FE 250/350/501 14-16	2112-1785
KTM	
SX 620 98	2112-1787
EXC 250/300/380 98-99	2112-1787
EXC 500/600 LC4 92	2112-1787

FITS MODEL	PART #
KTM (CONT)	
EXC 500/Six Days 12-16	2112-1785
EXC-F 250/350/450/500 Six Days 12-16	2112-1785
EXC-F 450 Rally Factory Replica 14,17	2112-1785
SUZUKI	
DR-Z 400 (kick start) 00-04	2112-1789

¹ Hot Shot series.



2112-1786



2112-1785



VOLTAGE REGULATORS

- OEM-quality voltage regulators for a variety of models

FITS MODEL	OEM #	PART #
KAWASAKI		
KX 250F 11-12	-	2112-1610

FITS MODEL	OEM #	PART #
KAWASAKI (CONT)		
KX 450F 09-11	-	2112-1610

FITS MODEL	OEM #	PART #
KAWASAKI (CONT)		
KLX 450R 08-17	21066-0015	2112-1774



2112-1610

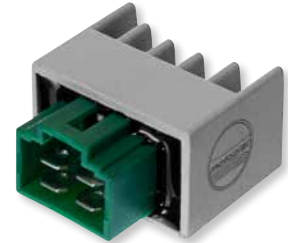

2112-1774



HOT SHOT SERIES STATORS

- OEM-style stators
- Direct plug-in stators complete with all rubbers and OEM-style plug end
- High-performance, heavy-duty Hot Shot series version made with a special Mosfet technology that does not get hot
- See page 1218 of the 2024 Parts Europe Offroad catalog for the complete line of Rick's Motorsport Stators

FITS MODEL	PART #
GASGAS	
MC 250 24-25	2112-1849
MC 250F/350F/450F 21-25	2112-1852
EX 250/300 24-25	2112-1849

FITS MODEL	PART #
GASGAS (CONT)	
EX 250F/350F/450F 21-25	2112-1852
HUSQVARNA	
FC 250/350/450 14-23	2112-1852

FITS MODEL	PART #
HUSQVARNA (CONT)	
TC 250 23-25	2112-1849
KTM	
SX 250/300 23-25	2112-1849
SX-F 250/350/450 15-23	2112-1852

2112-1849



STATOR REBUILD KIT FOR YAMAHA YZ 80 97-01

- Includes two banana-shaped coils and terminals; does not include the backing plate, grommet or connectors
- Installation instructions included
- See page 1218 of the 2024 Parts Europe Offroad catalog for the complete line of Rick's Motorsport Stator Rebuild Kits

DESCRIPTION	PART #
Stator rebuild kit	2112-1815



DISCLAIMER: SEE PAGE 4 FOR IMPORTANT INFORMATION REGARDING CERTAIN WARRANTY AND EMISSION CONTROL REGULATION COMPLIANCE AND NOISE REGULATION INFORMATION.

- EXHAUST
- LUGGAGE
- BIKE STANDS & ACCESSORIES
- HANDLEBARS & HAND CONTROLS
- FOOTPEGS & FOOT CONTROLS
- BODY
- GRAPHICS & SEATS
- SPROCKETS
- CHAINS
- BRAKES
- WHEELS & ACCESSORIES
- SUSPENSION
- ELECTRICAL & GAUGES
- LIGHTING
- ENGINE
- FUEL/AIR SYSTEMS
- HARDWARE & MERCHANDISING

EXHAUST

LUGGAGE

BIKE STANDS & ACCESSORIES

HANDLEBARS & HAND CONTROLS

FOOTPEGS & FOOT CONTROLS

BODY

GRAPHICS & SEATS

SPROCKETS

CHAINS

BRAKES

WHEELS & ACCESSORIES

SUSPENSION

ELECTRICAL & GAUGES

LIGHTING

ENGINE

FUEL/AIR SYSTEMS

HARDWARE & MERCHANDISING

2110-1325



STARTERS

- Affordable starters are constructed with longer-life bearings than OEM
- Many OEM starter motors have an unprotected output needle bearing on the outside of the output shaft's seal; moisture can and does enter the output cap of the electric motor and follows the armature shaft to the unprotected output needle bearing, which corrodes the bearing
- Rick's takes the extra step of installing a double-sealed ball bearing, with the output shaft seal on the outside of the bearing in their new aftermarket unit
- This simple application of common-sense engineering does two things: first, the outside bearing is now protected from damaging water entry, and second, the sealed ball bearing is replaceable
- See page 1221 of the 2024 Parts Europe Offroad catalog for the complete line of Rick's Motorsport Starters

FITS MODEL	PART #	FITS MODEL	PART #
HONDA		YAMAHA	
CRF 450X 05-17	2110-1325	WR 250F 03-12	2110-1330



HOT SHOT SERIES CDI BOX FOR HONDA XR 650L 93-21

- CDI box enhancements include duplicator circuits, increased rpm redline and altered ignition advance curves
- Designed to enhance overall performance when installing a high-flow jet kit
- Also may be used to replace defective CDI box on stock machines
- See page 1224 of the 2024 Parts Europe Offroad catalog for the complete line of Rick's Motorsport Hot Shot Series CDI Boxes

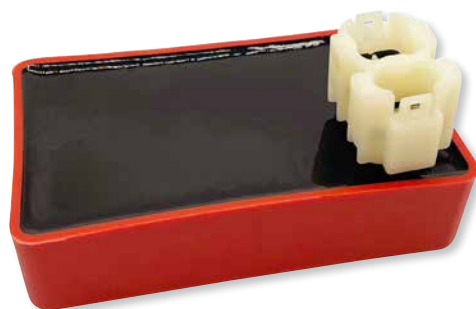

DESCRIPTION	PART #
Hot Shot series CDI box	2110-0479

LITHIUM-ION FRIENDLY CHARGING KIT

- Rick's Motorsport original design
- Includes both a stator and a lithium-ion friendly rectifier-regulator
- Will put out approximately 150W and power a 55W headlight if the bike's rotor has not been compromised
- Supplies constant power to the bike's battery
- See page 1227 of the 2024 Parts Europe Offroad catalog for the complete line of Rick's Motorsport Lithium-ion Friendly Charging Kits

NOTE: This kit is not for use with standard lead acid batteries. The voltage point is set to 14V +/- 2. Please contact the manufacturer of your lithium-ion battery to ensure the product has the correct set point.

FITS MODEL	PART #	FITS MODEL	PART #
HUSQVARNA		KTM	
TE 250/300 17-18	2112-1810	EXC 250/300 17-18	2112-1810



CHARGING KIT FOR YAMAHA WR 450F 07-09

- Kit includes high-output stator and rectifier/regulator
- See page 1227 of the 2024 Parts Europe Offroad catalog for the complete line of Rick's Motorsport Charging Kits

DESCRIPTION	PART #
Charging kit	2112-1819

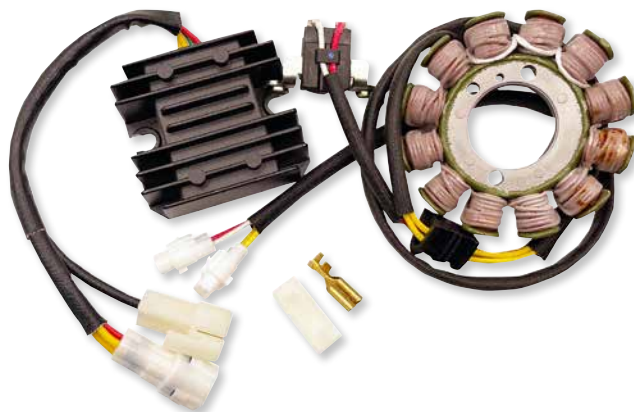

DISCLAIMER: SEE PAGE 4 FOR IMPORTANT INFORMATION REGARDING CERTAIN WARRANTY AND EMISSION CONTROL REGULATION COMPLIANCE AND NOISE REGULATION INFORMATION.



EXHAUST

LUGGAGE

BIKE STANDS & ACCESSORIES

HANDLEBARS & HAND CONTROLS

FOOTPEGS & FOOT CONTROLS

BODY

GRAPHICS & SEATS

SPROCKETS

CHAINS

BRAKES

WHEELS & ACCESSORIES

SUSPENSION

ELECTRICAL & GAUGES

LIGHTING

ENGINE

FUEL/AIR SYSTEMS

HARDWARE & MERCHANDISING

LED HEADLIGHT KIT

- 4380 lumen D4 LED lights
- Reliable PWM dimming decreases power draw on low setting
- LEDs last significantly longer than traditional halogen bulbs
- Powdercoated steel mounting frame & aluminum faceplate
- Spot & Hybrid lens included
- Includes plug-&-play high/low 12V wiring assembly and mounting hardware

FITS MODEL	PART #	FITS MODEL	PART #
HUSQVARNA		HUSQVARNA (CONT)	
TE 150/250/300 15-21	2001-2946	FE 350/450/501 17-23	2001-2946
FE 250 17-21	2001-2946		

LED HEADLIGHT KIT

- 4380 lumen D4 LED light
- Reliable PWM dimming decreases power draw on low setting
- LEDs last significantly longer than traditional halogen bulbs
- Powdercoated steel mounting frame & aluminum faceplate
- Spot & Hybrid lens included
- Includes plug-&-play high/low wiring adapter

FITS MODEL	PART #
KTM	
EXC 250/350/450/500 17-23	2001-2945



2001-2950



2001-2952



D7 LED LIGHT PODS W/ DATADIM™

- High-Intensity Series Cree LEDs outputting 7665 lumens per pod
- TriOptic™ Multi-Beam Lens System includes a Spot, Flood and Hybrid beam option in one pair of pods
- DataDim™ equipped light pods enable plug and play connection, and integrated dimming, with Denali dimming and lighting controllers
- DrySeal™ submersible waterproof light housings can withstand the most extreme environments
- Impact PC™ polycarbonate bezels won't crack, fade or corrode like traditional aluminum bezels

DESCRIPTION	PART #
D7 LED light pod	2001-2950

- LiveActive™ thermal management keeps the LEDs cool preventing the loss of light output from overheating
- Low profile mounting bracket with stainless steel hardware included
- PART #2001-2952 includes: light pod with clear lens installed (additional yellow lens included)
- Raw combined lumens: 15330
- Dimensions: 112 mm (4,4") x 66 mm (2,6")
- Sold each

DESCRIPTION	PART #
D7 LED light pod w/ yellow lenses	2001-2952



2040-3390



2040-3376

D7 LENS KITS

- D7 lens kits are designed to maximize visibility in foggy and rainy conditions
- Both amber and yellow color lenses increases visibility in fog and rain by blocking blue frequencies from the light, which reflect off water vapor and decrease vision
- Sold each

DESCRIPTION	PART #
Amber	2040-3390

DESCRIPTION	PART #
Yellow	2040-3376

EXHAUST

LUGGAGE



BIKE STANDS & ACCESSORIES

HANDLEBARS & HAND CONTROLS

FOOTPEGS & FOOT CONTROLS

BODY

GRAPHICS & SEATS

SPROCKETS

CHAINS

BRAKES

WHEELS & ACCESSORIES

SUSPENSION

ELECTRICAL & GAUGES

LIGHTING

ENGINE

FUEL/AIR SYSTEMS

HARDWARE & MERCHANDISING

D4 LED LIGHT PODS W/ DATADIM™

- High-Intensity Series Cree LEDs outputting 4380 lumens per pair
- TriOptic™ Multi-Beam Lens System includes a Spot, Flood and Hybrid beam option in one pair of pods
- DataDim™ equipped light pods enable plug and play connection, and integrated dimming, with Denali dimming and lighting controllers
- DrySeal™ submersible waterproof light housings can withstand the most extreme environments
- Impact PC™ polycarbonate bezels won't crack, fade or corrode like traditional aluminum bezels
- LiveActive™ thermal management keeps the LEDs cool preventing the loss of light output from overheating
- Low profile mounting bracket with stainless steel hardware included
- Dimensions: 99 mm (3,9") x 66 mm (2,6")



DESCRIPTION	PART #
D4 LED light pods	2001-2949

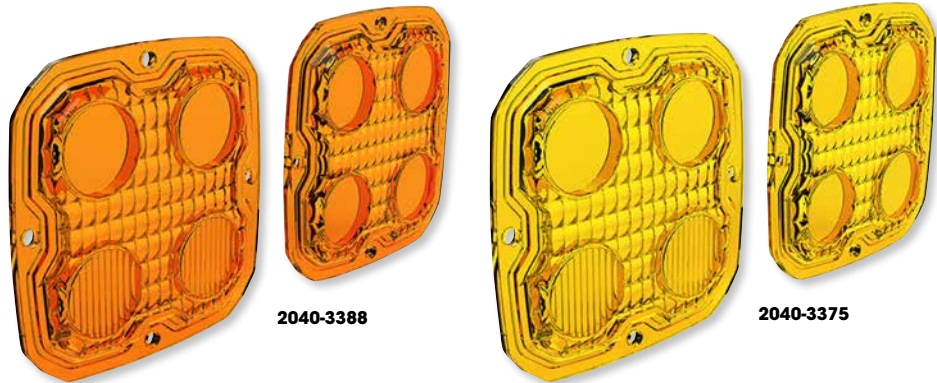

D4 TriOptic™ LENS KITS

- D4 TriOptic™ lenses have three distinct optical zones, allowing for different focal lengths or light patterns which increase visibility in various lighting conditions

- Kits include two spot lenses and two True-Hybrid™ lenses; use spot lenses for maximum distance, two Hybrid lenses for a balanced lighting solution

DESCRIPTION	PART #	DESCRIPTION	PART #
D4 TriOptic™ lens, amber	2040-3388	D4 TriOptic lens, yellow	2040-3375

SLIP-ON BLACKOUT COVERS

- The rugged silicone construction of the slip-on covers protect from rocks and other debris, providing a longer lifespan for your Denali D4 LED lights
- Blackout covers keep your bike street legal in states that require aftermarket lighting to be covered on public roads



DESCRIPTION	PART #
Blackout covers	2040-3389

DIALDIM™ LIGHTING CONTROLLER

- This controller allows you to manage two sets of lights independently with a single, intuitive interface
- The DialDim™ monitors your battery health, displaying voltage status on startup and implementing a low-voltage cutoff to prevent you from being stranded
- Designed for easy installation; comes with a 22 mm (7/8") handlebar mount, making it a perfect fit for most motorcycles
- Included Functions: on/off & dim, high/low sync, stealth mode, cancel with turn signal and strobe with horn

DESCRIPTION	PART #
DialDim™ lighting controller	2050-0544





BIG BORE CYLINDER KIT FOR YAMAHA YZ 250 99-25

- Ready-to-install, direct bolt-on cylinders require no re-plating and look virtually identical to the OEM cylinders
- Cylinder kits include matched Vertex pistons to ensure longevity, performance and reduced engine noise
- Nickel silicon carbide-plated for long life
- Kits come complete with gaskets, cylinder, piston, rings, pin and clips
- Big Bore cylinders do not require machine work
- For the full line of cylinder kits see pages 1281-1282 of the 2024 Parts Europe Offroad catalog



DESCRIPTION	BORE (MM)	PART #
Big Bore kit	72	0931-1163



TOP-END PISTON KITS

- All pistons are heat-treated with a T-5 hardening and tempering cycle
- All piston skirts are coated with a high-tech Molybdenum Disulphite coating for faster break-in time and increased piston life
- Cast piston kits are gravity-cast aluminum alloy (not forged) with 18% silicon content, which produces an extremely light but very strong piston
- Forged pistons are forged from 2618 aluminum for superior strength and durability
- Forged High Compression pistons improve power and torque across entire rpm range
- Forged Replica pistons are forged OEM replacements
- Replica pistons and all rings are OEM replacements
- Top-end piston kit includes piston, rings, pins, circlips, top-end gaskets, wrist pin bearing when applicable and cam chain when applicable



0910-6821

PISTON VERSIONS

Cast Replica - Cast OE replacement piston

Forged Replica - Forged OE stock compression piston

FITS MODEL	COMPRESSION RATIO	CYLINDER BORE (MM)	PISTON DIAMETER	DISPL (MM)	PISTON VERSION	TOP-END KIT PART #
FANTIC						
XX 125 22-25	STD	54,00	53,94	125	Forged Replica	0910-6823
	STD	54,00	53,95	125	Forged Replica	0910-6824
	STD	54,00	53,96	125	Forged Replica	0910-6825
XE 125 23-25	STD	54,00	53,94	125	Forged Replica	0910-6823
	STD	54,00	53,95	125	Forged Replica	0910-6824
	STD	54,00	53,96	125	Forged Replica	0910-6825
GASGAS						
MC 250 24-25	STD	72,00	71,925	300	Cast Replica	0910-6818
	STD	72,00	71,935	300	Cast Replica	0910-6819
EC 250 24-25	STD	72,00	71,925	300	Cast Replica	0910-6818
	STD	72,00	71,935	300	Cast Replica	0910-6819
HUSQVARNA						
TC 250 23-25	STD	66,40	66,34	250	Cast Replica	0910-6821
	STD	66,40	66,35	250	Cast Replica	0910-6822
TE 250 24-25	STD	72,00	71,925	300	Cast Replica	0910-6818
	STD	72,00	71,935	300	Cast Replica	0910-6819
TX 300 23-25	STD	72,00	71,925	300	Cast Replica	0910-6818
	STD	72,00	71,935	300	Cast Replica	0910-6819
KTM						
SX 250 23-25	STD	66,40	66,34	250	Cast Replica	0910-6821
	STD	66,40	66,35	250	Cast Replica	0910-6822
YAMAHA						
YZ 125 22-25	STD	54,00	53,94	125	Forged Replica	0910-6823
	STD	54,00	53,95	125	Forged Replica	0910-6824
	STD	54,00	53,96	125	Forged Replica	0910-6825

DISCLAIMER: SEE PAGE 4 FOR IMPORTANT INFORMATION REGARDING CERTAIN WARRANTY AND EMISSION CONTROL REGULATION COMPLIANCE AND NOISE REGULATION INFORMATION.

- EXHAUST
- LUGGAGE
- BIKE STANDS & ACCESSORIES
- HANDLEBARS & HAND CONTROLS
- FOOTPEGS & FOOT CONTROLS
- BODY
- GRAPHICS & SEATS
- SPROCKETS
- CHAINS
- BRAKES
- WHEELS & ACCESSORIES
- SUSPENSION
- ELECTRICAL & GAUGES
- LIGHTING
- ENGINE
- FUEL/AIR SYSTEMS
- HARDWARE & MERCHANDISING

EXHAUST

LUGGAGE

BIKE STANDS & ACCESSORIES

HANDLEBARS & HAND CONTROLS

FOOTPEGS & FOOT CONTROLS

BODY

GRAPHICS & SEATS

SPROCKETS

CHAINS

BRAKES

WHEELS & ACCESSORIES

SUSPENSION

ELECTRICAL & GAUGES

LIGHTING

ENGINE

FUEL/AIR SYSTEMS

HARDWARE & MERCHANDISING



PISTONS

- All pistons are heat-treated with a T-5 hardening and tempering cycle
- All piston skirts are coated with a high-tech molybdenum disulphite coating for faster break-in time and increased piston life
- Cast piston kits are gravity-cast aluminum alloy (not forged) with 18% silicon content, which produces an extremely light but very strong piston
- Forged pistons are forged from 2618 aluminum for superior strength and durability
- Forged high compression pistons improve power and torque across entire rpm range
- Replica pistons and all rings are OEM replacements
- For the complete line of Vertex Piston Kits, Rings, Wrist Pins and Circlips, see pages 1290-1317 of the 2024 Parts Europe Offroad catalog

FITS MODEL	STANDARD BORE (MM)	PISTON SIZE (MM)	VERSION	PISTON KIT PART #
FANTIC				
XX 125 23-25	54,00	53,95	Replica	0910-6832
	54,00	53,96	Replica	0910-6833
XE 125 22-24	54,00	53,95	Replica	0910-6832
	54,00	53,96	Replica	0910-6833
GASGAS				
MC 85 17/14 BW 22-24	46,95	47,00	Replica	0910-6830
	46,96	47,00	Replica	0910-6831
MC 85 19/16 BW 21-24	46,95	47,00	Replica	0910-6830
	46,96	47,00	Replica	0910-6831
MC 250 22-23	64,40	66,34	Replica	0910-6828
	64,40	66,35	Replica	0910-6829
EC 250 21-23	64,40	66,34	Replica	0910-6828
	64,40	66,35	Replica	0910-6829
HONDA				
CRF 250R 10-17	83,00	89,98	Replica	0910-2592
HUSQVARNA				
TC 85 17/14, 19/16 BW 18-24	46,95	47,00	Replica	0910-6830
	46,96	47,00	Replica	0910-6831



PISTON KITS

- Forged from aerospace-grade aluminum alloys and heat-treated for strength and durability using Wossner's state-of-the-art heat treatment process
- CNC-machined using MAZAK® advanced technology maintaining high precision and accuracy through every machining step
- Reduced product distortion and variability
- Enhanced piston pin oiling slots, radial boss machining and annular grooves for improved wrist pin lubrication
- Piston skirt profile and camming are specifically tailored to each application for reduced friction, smooth operation and reduced noise from rockover
- Piston skirts are coated for reduced friction and improved break-in performance
- Select applications have coating treatments to protect from harsh tuning environments
- Piston rings are made from premium alloy steel and feature treatments to improve ring seal and extend wear life
- Kits include piston, piston rings, piston pin and retaining clips
- See pages 1350-1357 of the 2024 Parts Europe Offroad catalog for the complete line of Wossner Piston kits

FITS MODEL	BORE SIZE	PISTON SIZE	OVERSIZE	COMPRESSION HEIGHT	STROKE	PART #
BETA						
RR 300 2T 22-24	73,0	72,95	STD	38,0	69,9	0910-6629
	73,01	72,96	0,01	-	-	0910-6630
	73,02	72,97	0,02	-	-	0910-6631
Xtrainer 300 2T 22-24	73,0	72,95	STD	38,0	69,9	0910-6629
	73,01	72,96	0,01	-	-	0910-6630
	73,02	72,97	0,02	-	-	0910-6631

¹ Premium series.

DISCLAIMER: SEE PAGE 4 FOR IMPORTANT INFORMATION REGARDING CERTAIN WARRANTY AND EMISSION CONTROL REGULATION COMPLIANCE AND NOISE REGULATION INFORMATION.



0910-2592

PISTON VERSIONS

Replica - Cast piston in original OE form

FITS MODEL	STANDARD BORE (MM)	PISTON SIZE (MM)	VERSION	PISTON KIT PART #
HUSQVARNA (CONT)				
TC 250 17-22	64,40	66,34	Replica	0910-6828
	64,40	66,35	Replica	0910-6829
TE 250/i 17-18	64,40	66,34	Replica	0910-6828
	64,40	66,35	Replica	0910-6829
KTM				
SX 85 17/14, 19/16 BW 18-24	46,95	47,00	Replica	0910-6830
	46,96	47,00	Replica	0910-6831
SX 250 17-22	64,40	66,34	Replica	0910-6828
	64,40	66,35	Replica	0910-6829
EXC 250/TPI 17-23	64,40	66,34	Replica	0910-6828
	64,40	66,35	Replica	0910-6829
SHERCO				
SE-R 250 17-22	66,40	66,35	Replica	0910-6826
	66,40	66,36	Replica	0910-6827
YAMAHA				
YZ125 22-25	54,00	53,95	Replica	0910-6832
	54,00	53,96	Replica	0910-6833



0910-6629

4-STROKE KITS

- Crown options available for stock and altered compression ratios
- Ring land treatments for improved ring seal and oil control, as well as gas porting on featured applications for the strongest compression ring seal

2-STROKE KITS

- Offered in standard graded sizes as well as oversizes for select applications
- Optimized machining for lightness, as well as maintaining strength in key areas such as crown and skirt wall cross-sections
- External machining optimized to prevent port venting for extreme applications with race porting

FITS MODEL	BORE SIZE	PISTON SIZE	OVERSIZE	COMPRESSION HEIGHT	STROKE	PART #
GASGAS						
MC 250F 24-25	81,00	80,95	STD	19,5	48,5	0910-6836¹
						0910-6843
MC 350F 24-25	88,00	87,95	STD	20,5	57,5	0910-6843
MC 450F 24-25	95,00	94,95	STD	22,8	63,4	0910-6845¹



PISTON KITS (CONT)

FITS MODEL	BORE SIZE	PISTON SIZE	OVERSIZE	COMPRESSION HEIGHT	STROKE	PART #
HUSQVARNA						
FC 250 23-25	81,00	80,95	STD	19,5	48,5	0910-6836¹
FC 350 23-25	88,00	87,95	STD	20,5	57,5	0910-6843
FC 450 23-25	95,00	94,95	STD	22,8	63,4	0910-6845¹
TE 300 14-17	72,0	71,94	STD	38,0	72,0	0910-6620
WR 300 09-13	72,0	71,94	STD	38,0	72,0	0910-4895
	72,01	71,95	0,01	-	-	0910-4896
	72,02	71,96	0,02	-	-	0910-4897
KTM						
SX-F 250 23-25	81,00	80,95	STD	19,5	48,5	0910-6836¹

FITS MODEL	BORE SIZE	PISTON SIZE	OVERSIZE	COMPRESSION HEIGHT	STROKE	PART #
KTM (CONT)						
SX-F 350 23-25	88,00	87,95	STD	20,5	57,5	0910-6843
SX-F 450 23-25	95,00	94,95	STD	22,8	63,4	0910-6845¹
EXC 300 06-17	72,0	71,94	STD	38,0	72,0	0910-6620
YAMAHA						
YZ 450F 23-25	97,00	96,96	STD	24,0	60,8	0910-6841
	97,00	96,96	STD	24,0	60,8	0910-6842

¹ Premium series.



CONNECTING RODS

- Designed to fit OEM bearing and crank pin
- For best results use corresponding Wössner piston kit
- Connecting rod kit contains all parts needed for crankshaft rebuild
- See pages 1363-1364 of the 2024 Parts Europe Offroad catalog for the full line of Wossner Connecting Rods



FITS MODEL	PART #	FITS MODEL	PART #
HUSQVARNA		KTM	
TC 65 17-25	0923-0421	SX 65 09-25	0923-0421



VALVE KITS

- Premium exhaust and intake valve kits made for durability and trouble free operation
- Stainless steel construction
- Includes all valves and springs

FITS MODEL	DESCRIPTION	PART #
HONDA		
CRF 250R 04-07	Exhaust	0926-3444
	Intake	0926-3445
CRF 250R 08-09	Exhaust	0926-3448
CRF 250R 10-11	Exhaust	0926-3449
CRF 250R 10-13	Intake	0926-3450
CRF 450R 02-06	Exhaust	0926-3452
CRF 450R 02-08	Intake	0926-3453
CRF 450R 07-08	Exhaust	0926-3454
CRF 250X 04-17	Exhaust	0926-3444
	Intake	0926-3445



FITS MODEL	DESCRIPTION	PART #
KAWASAKI		
KX 250F 04-08	Exhaust	0926-3451
KTM		
SX-F 250 06-12	Exhaust	0926-3446
	Intake	0926-3447
EXC-F 250 07-12	Exhaust	0926-3446
	Intake	0926-3447
SUZUKI		
RM-Z 250 04-08	Exhaust	0926-3451

ATHENA MOUNTING RUBBER

- For valve covers

FITS MODEL	PART #	FITS MODEL	PART #	FITS MODEL	PART #
YAMAHA		YAMAHA (CONT)		YAMAHA (CONT)	
YZ/WR 250F 01-06	0934-7479	YZ 426F 00-02	0934-7479	WR 400F 98-02	0934-7479
YZ 400F 98-99	0934-7479	YZ/WR 450F 03-06	0934-7479	WR 426F 01	0934-7479



DISCLAIMER: SEE PAGE 4 FOR IMPORTANT INFORMATION REGARDING CERTAIN WARRANTY AND EMISSION CONTROL REGULATION COMPLIANCE AND NOISE REGULATION INFORMATION.

EXHAUST

LUGGAGE

BIKE STANDS & ACCESSORIES

HANDLEBARS & HAND CONTROLS

FOOTPEGS & FOOT CONTROLS

BODY

GRAPHICS & SEATS

SPROCKETS

CHAINS

BRAKES

WHEELS & ACCESSORIES

SUSPENSION

ELECTRICAL & GAUGES

LIGHTING

ENGINE

FUEL/AIR SYSTEMS

HARDWARE & MERCHANDISING

EXHAUST



LUGGAGE

OEM STROKE CRANKSHAFT ASSEMBLY

- Premier alternative to costly OEM crankshaft
- Forged from 4140 steel and precision machined
- Sold complete and ready for installation with the original proven Hot Rods connecting rods, top end bearings and crankshaft webs
- Multi-cylinder applications are sold complete with main bearings (unless specified otherwise)
- Gears are made at a quality level of DIN class 9 or higher
- Assembly sold complete with Hot Rods connecting rod
- Factory assembled and trued to OEM specifications, Hot Rods cranks will meet or surpass the OEM in performance durability



- Ready for installation
- Crankshafts are fully rebuildable with genuine Hot Rods connecting rods and bearings (except Stroker)
- Main bearings not included
- See page 1366 of the 2024 Parts Europe Offroad catalog for the complete line of Hot Rods OEM crankshaft assemblies

BIKE STANDS & ACCESSORIES

HANDLEBARS & HAND CONTROLS

FITS MODEL	PART #	FITS MODEL	PART #	FITS MODEL	PART #
GASGAS		HUSQVARNA (CONT)		KTM (CONT)	
MC 125 21-23	0921-0945	TE 150 17-20	0921-0945	SX 150 16-21	0921-0945
HUSQVARNA		KTM		EXC 125 21/23	
TC 125 16-22	0921-0945	SX 125 16-21/23	0921-0945	EXC 150 17-20	0921-0945

FOOTPEGS & FOOT CONTROLS

BODY

GRAPHICS & SEATS



SPROCKETS

CRANKSHAFTS

- Performance replacement crankshaft assembly
- Includes crankshaft and connecting rod assembly
- Manufactured from premium materials for strength and durability
- Precision tolerances are maintained for smooth, trouble-free operation
- Includes top end bearing
- See page 1367 of the 2024 Parts Europe Offroad catalog for the complete line of Wossner Crankshafts

FITS MODEL	CRANKSHAFT PART #	FITS MODEL	CRANKSHAFT PART #
FANTIC		YAMAHA	
XX 125 22-25	0921-0946	YZ 125 22-25	0921-0946
		YZ 125X 23-25	0921-0946

CHAINS

BRAKES

WHEELS & ACCESSORIES



CRANKSHAFTS

- Fully assembled ready-to-install OEM replacement crankshaft assembly
- Heavy-duty forged connecting rod
- Includes wrist pin bearing(s)

FITS MODEL	PART #	FITS MODEL	PART #
HONDA		KAWASAKI	
CT 70 70-79	0921-0947	KDX 200 95-06	0921-0948
Z 50 69-79	0921-0948	KDX 220 97-05	0921-0948



SUSPENSION

CRANK BEARING AND SEAL KIT

- Precision crank bearings
- Kits contain right and left crankshaft bearings and outer seals
- Seals designed with a fluorocarbon lip to reduce dry start friction on 2-stroke engines
- See page 1368 of the 2024 Parts Europe Offroad catalog for the complete line of Moose Racing crank bearing/crank and seal kits



FITS MODEL	PART #	FITS MODEL	PART #
SUZUKI		SUZUKI (CONT)	
RM 80 89-01	A24-1014	RM 85/L 02-22	A24-1014

ELECTRICAL & GAUGES

LIGHTING

ENGINE



CRANKSHAFT GASKET KIT

- Top quality gasket kit for a complete crankshaft rebuild

FITS MODEL	PART #	FITS MODEL	PART #
SHERCO		SHERCO (CONT)	
SE 50 06-12	0921-0949	SM 50 06-12	0921-0949
SER 50 13-24	0921-0949	SM-5 50 13-24	0921-0949
SER-S 50 18-24	0921-0949	SM-RS 50 18-24	0921-0949

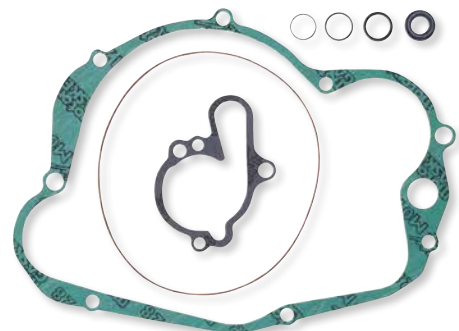

DISCLAIMER: SEE PAGE 4 FOR IMPORTANT INFORMATION REGARDING CERTAIN WARRANTY AND EMISSION CONTROL REGULATION COMPLIANCE AND NOISE REGULATION INFORMATION.

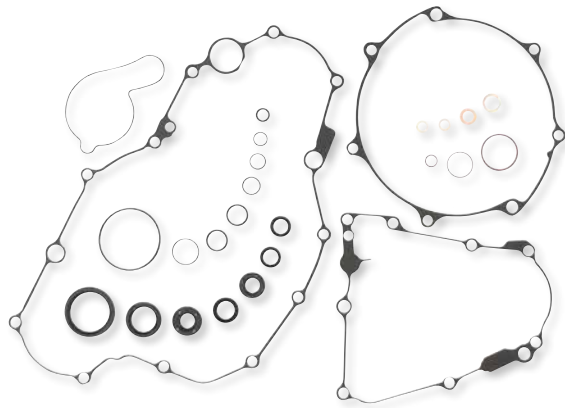

Complete bottom-end gasket kit

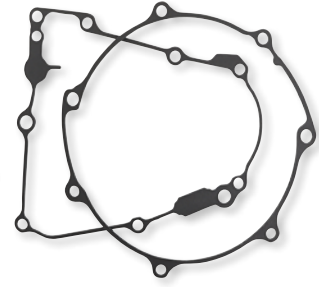

Clutch cover gasket



Complete oil seal kit

EXHAUST

LUGGAGE

BIKE STANDS & ACCESSORIES

HANDLEBARS & HAND CONTROLS

FOOTPEGS & FOOT CONTROLS

BODY

GRAPHICS & SEATS

SPROCKETS

CHAINS

BRAKES

WHEELS & ACCESSORIES

SUSPENSION

ELECTRICAL & GAUGES

LIGHTING

ENGINE

FUEL/AIR SYSTEMS

HARDWARE & MERCHANDISING

HI-PERFORMANCE OFFROAD GASKETS AND SEALS

- Gaskets and gasket sets used by professionals in high-performance machines and as OE replacements worldwide
- Each PART # contains the proper amount of gaskets for one application
- See pages 1374-1378 of the 2024 Parts Europe Offroad catalog for the complete line of Cometic Gaskets

TOP-END GASKET KITS

- Top end gasket kits include correct base, head gasket and cylinder O-rings as well as other top end specific O-rings or seals needed for R&R of top end
- Materials will vary depending on what is correct and engineered for specified application
- Purchase a top and a bottom end gasket kit for a complete gasket kit when doing a total engine rebuild

COMPLETE AND BASIC BOTTOM-END GASKET KITS

- Basic bottom end gasket kits include cover gaskets; some kits have crank seals (see footnote in chart)
- Complete bottom end kits include all necessary gaskets, seals and O-rings for a complete bottom end rebuild including crank seals
- Materials will vary depending on what is correct and engineered for specified application

NOTE: GASKET DESIGNATIONS: Reed=R, Power Valve=PV, Exhaust=E

TOP END GASKET KITS

FITS MODEL	BORE	TOP END GASKET KIT PART #
GASGAS		
MC 85/Big Wheel 21-25	-	0934-7801
MC 125 21-23	-	0934-7802
MC 250 24-25	-	0934-7803
MC 250 22-23	-	0934-7804
MC 250F 21-23	79 mm	0934-7806
MC 350F 22-23	90 mm	0934-7857
MC 350F 24-25	88 mm	0934-7862
MC 450F 21-25	95 mm	0934-7807
EC 250/300 21-23	-	0934-7804
EC 350F 24-25	88 mm	0934-7862
HONDA		
CRF 150R/RB 07-25	68 mm	0934-7824
CRF 250R/RX 18-21	79 mm	0934-7846
	82 mm	0934-7851
CRF 450R/X 07-18	96 mm	0934-7844
CRF 450R/RX/RWE 19-20	96 mm	0934-7850
CRF 450RL 21-23	96 mm	0934-7850
CRF 450R/RX/RWE 21-23	96 mm	0934-7859
HUSQVARNA		
TC 85 18-25	-	0934-7801
TC 125 23-25	-	0934-7802
TC 250 17-22	-	0934-7804
TC 250 23-25	-	0934-7803

FITS MODEL	BORE	TOP END GASKET KIT PART #
HUSQVARNA (CONT)		
FC 250 15-22	79 mm	0934-7806
FC 250 23-25	81 mm	0934-7805
FC 350 19-22	90 mm	0934-7857
FC 350 23-25	88 mm	0934-7862
FC 450 16-25	95 mm	0934-7807
TE 150 24-25	-	0934-7802
TE 250 17-20	-	0934-7804
TE 250 24-25	-	0934-7803
TE 300 17-20	-	0934-7804
TE 300 24-25	-	0934-7803
FE 350 24-25	88 mm	0934-7862
FE 450 17-25	95 mm	0934-7807
FE 501 17-25	95 mm	0934-7807
KAWASAKI		
KX 65 00-25	47 mm	0934-7866
	48 mm	0934-7867
KX 100 14-21	52.5 mm	0934-7840
KX 112 22-23	54.5 mm	0934-7841
KX 250 19-20	79 mm	0934-7856
KX 250/X 21-24	-	0934-7860
KX 450 19-20	96 mm	0934-7848
KX 450/SR/X 21-23	96 mm	0934-7861
KX 450 24	96 mm	0934-7865
KTM		
SX 85 18-25	-	0934-7801

FITS MODEL	BORE	TOP END GASKET KIT PART #
KTM (CONT)		
SX 85 (105 overbore) 18-25	-	0934-7864
SX 250 17-22	-	0934-7804
SX 250/300 23-24	-	0934-7803
SX-F 250 15-22	79 mm	0934-7806
SX-F 250 23-25	81 mm	0934-7805
SX-F 350 15-18	88 mm	0934-7843
	90 mm	0934-7853
	91 mm	0934-7854
SX-F 350 19-22	90 mm	0934-7857
SX-F 350 23-25	88 mm	0934-7862
SX-F 450 19-25	95 mm	0934-7807
EXC 150 24-25	-	0934-7802
EXC 250 17-23	-	0934-7804
EXC 250/300 24-25	-	0934-7803
EXC 300 17-23	-	0934-7804
EXC-F 250 17-23	79 mm	0934-7806
EXC-F 350 20-23	90 mm	0934-7857
EXC-F 350 24-25	88 mm	0934-7862
EXC-F/Six Days 450/500 17-25	95 mm	0934-7807
EXC-F 500 20-22	95 mm	0934-7807
SUZUKI		
RM 65 03-08	47 mm	0934-7866
	48 mm	0934-7867

CLUTCH COVER GASKETS

- Clutch cover gaskets are made from an AFM material which is a chemically-blown, compounded nitrile synthetic rubber bonded to an aluminum core
- Aluminum core gives the gasket strength for a superior seal and prevents the gasket from weeping or crawling out in today's engine cases with limited sealing surfaces
- No sealants required for installation
- Saves service time as AFM will not stick to the engine case, making replacement quick and easy, no more scraping

COMPLETE CRANKSHAFT AND OIL SEAL KITS

- Domestically made sets include the correct number of seals for one application
- Available in complete oil seal sets as well as crankshaft oil seal kits

HI-PERFORMANCE OFFROAD GASKETS AND SEALS continued on next page.

DISCLAIMER: SEE PAGE 4 FOR IMPORTANT INFORMATION REGARDING CERTAIN WARRANTY AND EMISSION CONTROL REGULATION COMPLIANCE AND NOISE REGULATION INFORMATION.



HI-PERFORMANCE OFFROAD GASKETS AND SEALS (CONT)

EXHAUST

LUGGAGE

BIKE STANDS & ACCESSORIES

HANDLEBARS & HAND CONTROLS

FOOTPEGS & FOOT CONTROLS

BODY

GRAPHICS & SEATS

SPROCKETS

CHAINS

BRAKES

WHEELS & ACCESSORIES

SUSPENSION

ELECTRICAL & GAUGES

LIGHTING

ENGINE

FUEL/AIR SYSTEMS

HARDWARE & MERCHANDISING

TOP END GASKET KITS (CONT)

FITS MODEL	BORE	TOP END GASKET KIT PART #	FITS MODEL	BORE	TOP END GASKET KIT PART #	FITS MODEL	BORE	TOP END GASKET KIT PART #
SUZUKI (CONT)			YAMAHA (CONT)			YAMAHA (CONT)		
RM-Z 250 10-23	77 mm	0934-7832	YZ 250F 14-18	77 mm	0934-7842	YZ 450F 23-25	97 mm	0934-7863
	79 mm	0934-7833	YZ 250FX 15-19	77 mm	0934-7842	WR 250F 15-19	77 mm	0934-7842
	80 mm	0934-7834	YZ 250F/X 19-25	77 mm	0934-7847	WR 250F 20-24	77 mm	0934-7847
	82 mm	0934-7836		80 mm	0934-7852		80 mm	0934-7852
	84 mm	0934-7837	YZ 450F 06-09	98 mm	0934-7825	WR 450F 07-15	98 mm	0934-7825
RM-Z 450 08-25	97 mm	0934-7827		99 mm	0934-7829		99 mm	0934-7829
RMX 450Z 10-19	99 mm	0934-7828	YZ 450F 14-17, YZ450FX 16-18	97 mm	0934-7839	WR 450F 16-18	97 mm	0934-7839
	101 mm	0934-7831	YZ 450F 18-19, YZ450FX 19-20	97 mm	0934-7845	WR 450F 19-20	97 mm	0934-7845
YAMAHA			YZ 450F 20-22, YZ450FX 21-23	97 mm	0934-7855	WR 450F 21-23	97 mm	0934-7855
YZ 65 18-25	-	0935-1299						
YZ 85 19-25	-	0934-7849¹						
YZ 125/X 22-25	-	0934-7826						

¹ Includes cylinder head o-rings.

OTHER GASKETS

FITS MODEL	BOTTOM END GASKET KIT PART #	CLUTCH COVER PART #	COMPLETE OIL SEAL KIT PART #
YAMAHA			
YZ 450F 06-09	0934-7874	0934-7875	0935-1301
WR 450F 07-09, 11-15	0934-7874	0934-7875	0935-1301

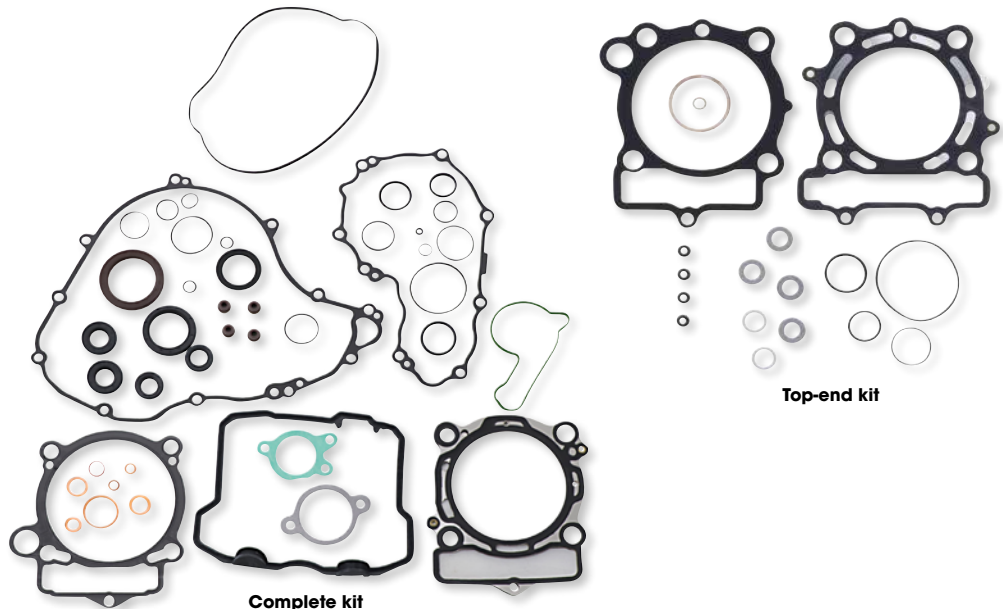

GASKET SETS

- Superior-quality gasket sets from Athena S.p.A
- Head gaskets feature rubber-coated spring steel construction
- Soft steel base gaskets are rubber coated
- Steel core materials feature high spring-back and superior tensile strength
- Revolutionary transparent coating guarantees a perfect seal even at extremely high temperatures
- High-temperature blue silicone beading on most critical flat gaskets
- See pages 1388 to 1390 of the 2024 Parts Europe Offroad catalog for the full line of Athena Gasket Sets

TOP-END RACE GASKET KITS

- Specifically designed for the pro, semi-pro and amateur rider who freshens up their engine prior to a race or during mid-season
- Kits include a top-of-the line MLSS head gasket and two or more premium quality base gaskets of different thicknesses to optimize engine compression ratios
- Gives the rider a choice of using standard gas with stock compression, or race gas with a higher compression
- Kits do not include valve stem seals, rubber parts, shims, or other fiber gaskets

TOP-END AND COMPLETE GASKET KITS

- Include all necessary top-quality gaskets, rubber parts and valve stem seals to rebuild top-end and complete engines respectively

TOP END AND COMPLETE GASKET SETS

FITS MODEL	TOP-END GASKET KIT	COMPLETE GASKET KIT	FITS MODEL	TOP-END GASKET KIT	COMPLETE GASKET KIT
BETA					
RR Racing 2T 125 19-22	0934-7894	-	MC 250F 24-25	0934-7897	-
RR Racing 2T 125 19-25	-	0934-7891	MC 450F 21-23	-	0934-6353
RR 125 2T 18-25	0934-7894	0934-7891	EC 250/300 21-23	-	0934-7890
RR 250 2T 13-22	0934-7506	0934-7509	EC 250/300 24-25	0934-7892	0934-7893
RR 300 2T 13-22	-	0934-7509	EC 250F 24-25	0934-7897	-
GASGAS					
MC 250 24-25	0934-7982	0934-7893	EC 350F 21-23	-	0934-6352

DISCLAIMER: SEE PAGE 4 FOR IMPORTANT INFORMATION REGARDING CERTAIN WARRANTY AND EMISSION CONTROL REGULATION COMPLIANCE AND NOISE REGULATION INFORMATION.

ATHENA GASKET SETS (CONT)

TOP END AND COMPLETE GASKET SETS (CONT)

FITS MODEL	TOP-END GASKET KIT	COMPLETE GASKET KIT
HONDA		
CRF 450R 17-18	-	0934-5464
CRF 450X 05-15, 17	-	0934-1995
CRF 500X 05-09	-	0934-1995
HUSABERG		
FE 390 10-11	0934-2858	-
FE 450 09-11	0934-2858	-
HUSQVARNA		
TC 250 17-22	-	0934-7890
TC 250 23-25	0934-7892	0934-7893
FC 250 23-25	0934-7897	0934-7895
FC 350 19-22	-	0934-6352
FC 450 19-22	-	0934-6352
TE 250/300 17-23	-	0934-7890
TE 250/300 24-25	0934-7892	0934-7893
TE 610 01	-	0934-7951²
FE 250 24-25	0934-7897	0934-7895
FE 350 20-23	-	0934-6352
KAWASAKI		
KX 250F 21-25	0934-7507	0934-7510
KMX 125 85-93	0934-1767	-
KTM		
SX 250 17-22	-	0934-7890
SX-F 250 06-12	-	0934-1821²
SX-F 250 23-25	0934-7897	0934-7893
-	-	0934-7895
SX-F 350 19-22	-	0934-6352
SX-F 450 19-22	-	0934-6353

TOP-END RACE GASKET KITS

FITS MODEL	PART #	FITS MODEL	PART #
GASGAS		HUSQVARNA	
MC 250 22-23	0934-7794	TC 250 17-22	0934-7794
EC 250/300 21-23	0934-7794	TE 250/300 17-23	0934-7794

FITS MODEL	TOP-END GASKET KIT	COMPLETE GASKET KIT
KTM (CONT)		
EXC 250/300 17-25	-	0934-7890
EXC 400 05-11	0934-2858	0934-2794¹
EXC 530 08-11	0934-2858	0934-2794¹
EXC Racing 450 08-15	0934-2858	0934-2794¹
EXC-F 250 05-13	-	0934-1821²
EXC-F 250 24	0934-7897	0934-7893
-	-	0934-7895
EXC-F 350 20-25	-	0934-6352
EXC-F 450 07-11	0934-2858	0934-2794¹
SUZUKI		
RM-Z 250 07-09	-	0934-2006²
RM-Z 250 10-15	-	0934-2544²
RM-Z 250 19-25	0934-7508	0934-7511
RM-Z 450 08-25	-	0934-2007²
YAMAHA		
YZ 250F 14-18	0934-3171	0934-3172
YZ 250FX 15-19	0934-3171	0934-3172
YZ 450F 20-22	-	0934-6471
YZ 450F 23-25	0934-7982	0934-7983
YZ 450FX 21-22	-	0934-6471
YZ 450FX 24-25	-	0934-7983
WR 250F 15-17	0934-3171	0934-3172
WR 450F 21	-	0934-6471
WR 450F 24-25	0934-7982	0934-7983

¹ Does not include valve cover gaskets.

² Does not include oil seals.

ATHENA

REPLACEMENT VALVE COVER GASKETS

- Replace your worn-out valve gaskets with these high quality gaskets from Athena
- Created using the best raw materials available and state-of-the-art processing such as in-line laser cutting and multi-stage stamping technologies
- Individually packed with cardboard backing
- See pages 1391-1393 of the 2024 Parts Europe Offroad catalog for the full line of Athena Replacement Gaskets

FITS MODEL	PART #	FITS MODEL	PART #
HM MOTO		HM MOTO (CONT)	
CRE-F 250 05-09, 12	0934-6769	CRE-F 450R 05-08	0934-6769
CRE-F 250X 05-11, 13	0934-6769	CRE-F 450X 05-09	0934-6769
CRE-F 300X 08-13	0934-6769	CRE-F 490X 07-08	0934-6769

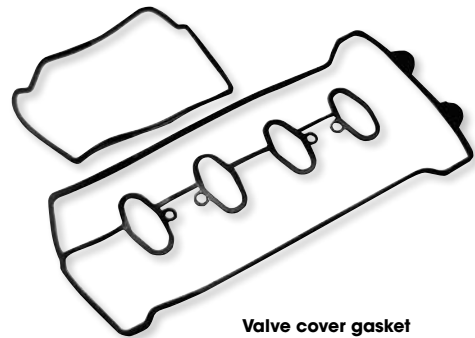

Valve cover gasket

FITS MODEL	PART #
HM MOTO (CONT)	
CRE-F 500X 09-10	0934-6769
CRM-F 450R 09-11	0934-6769
CRM-F 450X 07-11	0934-6769
CRM-F 490X 07-08	0934-6769

ATHENA

ENGINE OIL SEAL KITS

- Includes all oil seals needed to replace OEM
- See pages 1408 and 1409 of the 2024 Parts Europe Offroad catalog for the complete line of Athena Engine Oil Seal Kits

FITS MODEL	PART #	FITS MODEL	PART #	FITS MODEL	PART #
BETA		HONDA		KTM	
RR 2T 250/300 13-25	0934-7899	CRF 250R 18-25	0934-7900	SX 250 17-25	0934-7896
GASGAS		HUSQVARNA		SX 300 23-25	0934-7896
MC 250 22-24	0934-7896	TC 250 17-25	0934-7896	EXC 250/300 17-24	0934-7896
EC 250/300 21-24	0934-7896	TE 125 10-13	0934-7975	YAMAHA	
-	-	TE 250/300 17-25	0934-7896	WR 125R 09-11	0934-7975



DISCLAIMER: SEE PAGE 4 FOR IMPORTANT INFORMATION REGARDING CERTAIN WARRANTY AND EMISSION CONTROL REGULATION COMPLIANCE AND NOISE REGULATION INFORMATION.

- EXHAUST
- LUGGAGE
- BIKE STANDS & ACCESSORIES
- HANDLEBARS & HAND CONTROLS
- FOOTPEGS & FOOT CONTROLS
- BODY
- GRAPHICS & SEATS
- SPROCKETS
- CHAINS
- BRAKES
- WHEELS & ACCESSORIES
- SUSPENSION
- ELECTRICAL & GAUGES
- LIGHTING
- ENGINE
- FUEL/AIR SYSTEMS
- HARDWARE & MERCHANDISING

EXHAUST

LUGGAGE

BIKE STANDS & ACCESSORIES

HANDLEBARS & HAND CONTROLS

FOOTPEGS & FOOT CONTROLS

BODY

GRAPHICS & SEATS

SPROCKETS

CHAINS

BRAKES

WHEELS & ACCESSORIES

SUSPENSION

ELECTRICAL & GAUGES

LIGHTING

ENGINE

FUEL/AIR SYSTEMS

HARDWARE & MERCHANDISING

0940-2192



IGNITION COVERS

- Made from machined billet aircraft-quality aluminum for added strength
- Stronger than OEM covers
- Dissipates heat better than OEM cover
- Hard-coated finish for long-lasting durability

FITS MODEL	PART #	FITS MODEL	PART #
HUSQVARNA		YAMAHA	
FC 250/300 23	0940-2190	YZ 125 05-22	0940-2192
TE 250/300 19-23	0940-2193	YZ 125X 20-22	0940-2192
KTM		YZ 450F 23	0940-2191
SX-F 250/350 20-22	0940-2190		



CLUTCH COVERS

- Made from machined billet aircraft-quality aluminum for added strength
- Stronger than OEM covers
- Dissipates heat better than OEM cover
- Hard-coated finish for long-lasting durability
- See page 1412 of the 2024 Parts Europe Offroad catalog for the complete line of Moose Racing Clutch Covers

DESCRIPTION	PART #	DESCRIPTION	PART #
HUSQVARNA		SHERCO	
TC 125 23	0940-2188	SER-R 250/300 14-21	0940-2187
KTM		SER 125 18-19, 21	0940-2187
SX 125 23	0940-2189	YAMAHA	
		YZ 450F 23-24	0940-2188



CLUTCH COVERS

- Rekluse clutch covers are specifically engineered to provide unparalleled durability and performance in a single, stylish component
- Covers are ready to ride whenever you are, standing up against rocks, logs, boots and whatever else you may encounter in your adventures
- Billet aluminum construction provides incredible strength
- Clutch covers are double hard anodized to further enhance durability and wear resistance
- Rekluse covers have a greater depth than OEM designs, allowing increased oil capacity
- See page 1416 of the 2024 Parts Europe Offroad catalog for additional Rekluse clutch covers

FITS MODEL	PART #	FITS MODEL	PART #	FITS MODEL	PART #
HUSQVARNA		KAWASAKI		KTM	
TC 65 17/14, 19/16 BW 14-17	0940-1794	KX 80 17/14, 19/16 BW 98-00, KX 85 17/14, 19/16 BW 07-24, KX 100 98-18	0940-1802	SX 85 17/14, 19/16 BW 03-17, SX 105 04-11	0940-1794

0940-1794



0940-1802



CLUTCH COVER FOR TRIUMPH TF 250-X 24

- Improves heat dissipation
- Stronger than stock
- Precision machined from billet T6 aircraft-quality aluminum
- Race proven by virtually every factory race team
- Hard-coated to resist boot wear

DESCRIPTION	PART #
Clutch cover	0940-2211



FACTORY CLUTCH COVER REPLACEMENT GASKET

FOR HONDA CR250R 02-07

- Replacement gasket for Factory Clutch Cover PART #s CC-02AB and 0940-0223
- See full line of Factory Clutch Covers and Replacement Gaskets on pages 1412-1414 of the 2024 Parts Europe Offroad catalog

DESCRIPTION	PART #
Clutch cover gasket	0934-7889

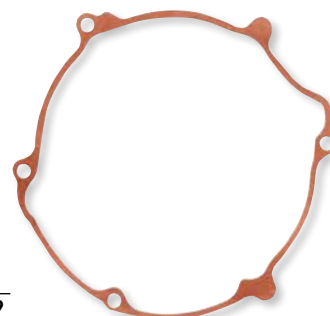

DISCLAIMER: SEE PAGE 4 FOR IMPORTANT INFORMATION REGARDING CERTAIN WARRANTY AND EMISSION CONTROL REGULATION COMPLIANCE AND NOISE REGULATION INFORMATION.



All Rekluse clutch products are precision-engineered and made of high-quality materials to provide the best in performance and durability. Their components are stronger, lighter, longer-lasting and built for maximum performance. Rekluse's industry-leading auto clutches are optimized for each bike model as it comes from the factory and they've designed each clutch to be fine-tuned for every rider. Rekluse's manual clutches deliver unprecedented performance, tuning and durability with a design that provides more discs in less space, allowing up to four additional friction discs over stock.

RADIUSCX 4.0

- Eliminates stalling, start and stop without engaging the clutch lever
- Increased power transfer over OEM
- On-the-fly external adjustment
- Allows riders to run a gear taller, letting the suspension work better and saving energy
- TorqDrive® disks and EXP 4.0 provide stronger power delivery and a more reliable, responsive clutch modulation
- Rekluse's billet Core components help keep the clutch cooler and resist wear with improved oil flow and hard anodized coatings, plus provide an improved, consistent lever feel
- Provided with basket sleeves to prevent clutch baskets from notching, the RadiusCX is the ultimate performance auto clutch kit that can be setup to fit almost any rider's preferences
- Retains full, normal use of the clutch lever to fully override the auto functionality at any time



1130-0782

- Improves rider control, maximizes traction and confidence to navigate challenging terrain
- Improved oil flow and cooling with Core components aids in durability
- Rekluse clutch cover improves strength and durability over stock, and adds a factory look
- See page 1419 of the 2024 Parts Europe Offroad catalog for additional Rekluse RadiusCX 4.0 clutch kits

FITS MODEL	PART #	FITS MODEL	PART #	FITS MODEL	PART #
BETA		HUSQVARNA (CONT)		KTM (CONT)	
RX 200 2T 24	1130-0782	TC 250 14-16	1130-0815	SX-F 250 13-15	1130-0816
RR 250/300 2T 24	1130-0782	FC 250/350 14-15	1130-0816	SX-F 350 11-15	1130-0816
RR X-Pro 2T 250/300 25	1130-0782	TE 150 21-23	1130-0858	EXC 150 20-23	1130-0858
RR Racing 2T 250/300 24	1130-0782	TE 250 14-16	1130-0815	EXC 250/Six Days 13-16	1130-0815
Xtrainer 250/300 24	1130-0782	TE 300 14-16	1130-0815	EXC 300/Six Days 13-16	1130-0815
GASGAS		FE 450 17-21	1130-0810	EXC-F 450/Six Days 17-23	1130-0810
MC 125 21-23	1130-0858	FE 450 24-25	1130-0846	EXC-F 450/Six Days 24-25	1130-0846
EC 250F 10-15	1130-0798	FE 501 17-21	1130-0810	EXC-F 500/Six Days 17-23	1130-0810
EC 300F 13-15	1130-0798	FE 501 24	1130-0846	EXC-F 500/Six Days 24-25	1130-0846
EC 450F/500F 24-25	1130-0846	KAWASAKI		SHERCO	
HONDA		KX 250F 09-20	1130-0788	SE 250/300 Factory 24-25	1130-0809
CR 250R 92-01	1130-0772	KX 250/250X 24	1130-0793	SUZUKI	
CR 500R 90-01	1130-0772	KX 450F 16-18	1130-0789	RM-Z 250 24-25	1130-0795
CRF 250R/RX 25	1130-0773	KX 450 19-20	1130-0791	RM-Z 450 24-25	1130-0794
CRF 450R/RX/RWE 24	1130-0774	KX 450/450X 24-25	1130-0792	YAMAHA	
HUSABERG		KTM		YZ 250F 01-13	1130-0798
TE 250/300 13-14	1130-0815	SX 125 19-25	1130-0858	YZ 450F 24-25, YZ 450FX 24	1130-0804
HUSQVARNA		SX 150 19-22	1130-0858	WR 250F 01-14	1130-0798
TC 125 19-25	1130-0858	SX 250 13-16	1130-0815	WR 450F 24	1130-0804

RADIUSX 4.0

- Eliminates stalling; start and stop without engaging the clutch lever
- Increased power transfer over OEM
- On-the-fly external adjustment
- Allows riders to run a gear taller, letting the suspension work better and saving energy
- TorqDrive® clutch pack provides longer clutch life with less adjustment over time
- Retains full, normal use of the clutch lever to fully override the auto functionality at any time



- Improves rider control, maximizes traction and confidence to navigate challenging terrain
- Adjustable slave cylinder for models with hydraulic clutch
- Basket sleeves protect OEM baskets from notching
- See pages 1421-1422 of the 2024 Parts Europe Offroad catalog for additional Rekluse RadiusX 4.0 clutches

FITS MODEL	PART #	FITS MODEL	PART #
BETA		YAMAHA	
RX 300 2T 22-25, RR Racing 250/300 2T 22-24, RR 2T 250/300 22-25, RR X-Pro 250/300 2T 25, Xtrainer 250/300 22-25	1130-0712	Tenere 700 21-24	1130-0864

DISCLAIMER: SEE PAGE 4 FOR IMPORTANT INFORMATION REGARDING CERTAIN WARRANTY AND EMISSION CONTROL REGULATION COMPLIANCE AND NOISE REGULATION INFORMATION.

- EXHAUST
- LUGGAGE
- BIKE STANDS & ACCESSORIES
- HANDLEBARS & HAND CONTROLS
- FOOTPEGS & FOOT CONTROLS
- BODY
- GRAPHICS & SEATS
- SPROCKETS
- CHAINS
- BRAKES
- WHEELS & ACCESSORIES
- SUSPENSION
- ELECTRICAL & GAUGES
- LIGHTING
- ENGINE
- FUEL/AIR SYSTEMS
- HARDWARE & MERCHANDISING



EXHAUST

LUGGAGE

BIKE STANDS & ACCESSORIES

HANDLEBARS & HAND CONTROLS

FOOTPEGS & FOOT CONTROLS

BODY

GRAPHICS & SEATS

SPROCKETS

CHAINS

BRAKES

WHEELS & ACCESSORIES

SUSPENSION

ELECTRICAL & GAUGES

LIGHTING

ENGINE

FUEL/AIR SYSTEMS

HARDWARE & MERCHANDISING

RADIUSX CLUTCH KITS

- With RadiusX a high-performance auto clutch is just a clutch pack swap away
- RadiusX combines TorqDrive® friction disk technology with Rekluse's innovative EXP (auto clutch) disk
- TorqDrive provides more clutch disks in less space, delivering high performance auto function within the framework of the stock clutch
- The RadiusX clutch prevents engine stalls so you can focus on the ride and let the auto clutch do the rest
- RadiusX delivers increased power transfer over OEM and longer clutch life with less adjustment over time
- Standard clutch lever function is retained and full override
- Some configurations include Rekluse basket sleeves to prolong basket life
- See pages 1420-1421 of the 2024 Parts Europe Offroad catalog for additional RadiusX clutch kit applications



FITS MODEL	PART #
KOVE 450 24	1130-0869

CORE EXP 4.0 CLUTCH FOR YAMAHA YZ 65 18-25/YZ 85 02-25

- Updated EXP (expanding friction disk) assembly
- Base material updated to provide better strength in high temperature environments, critical for the heat clutch systems create
- Internal wall bases redesigned for strength and rigidity, which helps translate to a more connected lever feel for the rider
- On the outside of the EXP disk, friction pads now match proprietary friction design found on Rekluse TorqDrive® clutch plates, this design helps match oil flow characteristics on the clutch pack beneath, promoting improved cooling capability and consistent operation
- EXP 4.0 wedges have been improved to now use rolling contact with built-in pins

- Rolling pins versus sliding creates less friction and resistance, providing smoother engagement and a more responsive feel, creating stronger power delivery overall
- More direct power delivery, improved durability, and rider-focused functionality
- Engagement curve designs updated to better match modern motorcycle engine characteristics
- More tuning options with varying wedge weights and EXP springs

DESCRIPTION	PART #
Core EXP 4.0 clutch	1130-0865

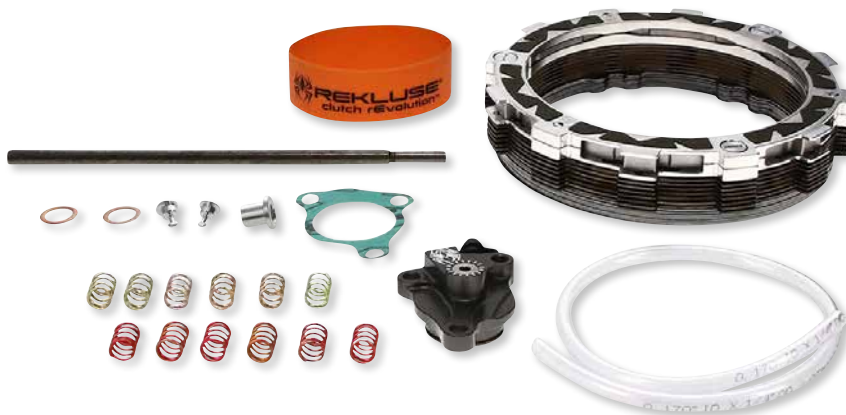

CORE MANUAL TORQDRIVE® CLUTCH KIT

- The Core Manual TorqDrive® clutch delivers unprecedented performance, tuning and durability
- TorqDrive provides more disks in less space, allowing up to four additional friction disks over stock
- More frictions = more torque capacity, thus unlocking the full power of your engine without the need to add stiffer pressure plate springs
- Provides more consistent clutch lever feel and behavior
- Can be set up to maintain a stock or lighter than stock, lever pull depending on engine tuning
- Rekluse sleeves eliminate basket wear and notching
- Proven in racing at the highest levels
- See page 1424 of the 2024 Parts Europe Offroad catalog for additional Rekluse Core Manual TorqDrive clutch kits



FITS MODEL	PART #
HONDA CR 250R 94-01, CR 500R 00-01	1130-0378

DISCLAIMER: SEE PAGE 4 FOR IMPORTANT INFORMATION REGARDING CERTAIN WARRANTY AND EMISSION CONTROL REGULATION COMPLIANCE AND NOISE REGULATION INFORMATION.

F70-5171-3

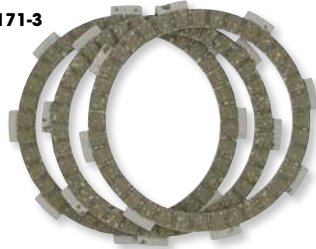

CLUTCH FRICTION PLATES

- DP manufactures these with heat-resistant friction material for fade-free performance
- Ready to install, no need to soak in oil
- Designed to ensure ultra-smooth power delivery
- Sold in sets
- See pages 1432-1434 of the 2024 Parts Europe Offroad catalog for Moose Racing's full line of clutch friction plates

FITS MODEL	FRICTION PLATE SET PART #	SPRING SET PART #
HONDA		
CR 80/85R 86-07	-	FHDS4-4
CRF/XR 80R 83-09	F70-5171-3	-
CRF 450R 11-16	F70-5255-8	-
XR 250L 91-92	-	FHDS4-4
KAWASAKI		
KX 80/85/100 01-22	F70-5345-6	FHDS74-4
KX 112 22-24	F70-5345-6	FHDS74-4
KX 125 94-08	F70-5320	-
KX 250 88-89, 92-08	-	FHDS7-6
KX 500 87-04	-	FHDS7-6
KLX 400 03-04	F70-5255-8	-
KLR 650 87-15	-	FHDS7-6

FHDS27-6



CLUTCH SPRINGS

- Precision-wound using the finest chrome silicon wire
- Heat-treated and shot-peened for maximum life
- Designed for stronger performance without a harder lever pull
- Sold in sets
- See pages 1432-1434 of the 2024 Parts Europe Offroad catalog for Moose Racing's full line of clutch springs

FITS MODEL	FRICTION PLATE SET PART #	SPRING SET PART #
KTM		
SX/EXC 125 98-05	F70-5502-7	-
EXC/EGS/MXC 200 98-17	F70-5502-7	-
SX/EXC/EGS/MXC 250/300/360/380 90-12	-	FHDS78-6
SUZUKI		
DR-Z 400 00-23 (all)	F70-5255-8	-
YAMAHA		
YZ 125 93-24	F70-5406	-
YZ/WR 250 93-99	F70-5403	-
YZ 250 02-24	F70-5403	FHDS93-6
TTR 125/L 00-24	F70-5462-5	FHDS42-4



MSK CLUTCH SUPER KIT FOR KTM SX 125 98-15

- Complete clutch kit contains springs, friction and steel plates together with a clutch cover gasket
- An alternative to standard clutch components
- See page 1436 of the 2024 Parts Europe Offroad catalog for the complete line of TRW MSK Clutch Super Kits



DESCRIPTION	PART #
MSK clutch super kit	1131-3711



DPK CLUTCH KITS

- Designed to outperform any OEM or aftermarket clutch
- DPK kits include friction plates, steel drive plates and diaphragm springs
- DP clutch kits come in a foam-lined hard plastic case that protects clutch components from being damaged prior to installation
- Case can be used to store and transport parts, tools or other items after clutch is installed
- See page 1444 of the 2024 Parts Europe Offroad catalog for the complete line of DPK Clutch Kits

FRICTION PLATES

- Come ready to race - no need to presoak plates in oil
- Designed to ensure ultrasmooth power delivery
- Exclusive high-heat friction materials for fade-free performance
- Friction compounds designed to suit off-road and dual-sport bikes
- More durable than OE plates

FITS MODEL	PART #
KAWASAKI	
KX 250/X - Diaphragm Spring 21-24	1131-3907

STEEL DRIVE PLATES

- Steel plates won't expand; will not fade or promote clutch swell like stock aluminum plates
- Long lasting - up to 300% more life than stock plates
- Increased weight over stock plates adds flywheel effect for aiding starting and traction
- Will not muddy or contaminate oil

FITS MODEL	PART #
KAWASAKI (CONT)	
KX 450/X - Diaphragm Spring 21-23	1131-3908



DISCLAIMER: SEE PAGE 4 FOR IMPORTANT INFORMATION REGARDING CERTAIN WARRANTY AND EMISSION CONTROL REGULATION COMPLIANCE AND NOISE REGULATION INFORMATION.

- EXHAUST
- LUGGAGE
- BIKE STANDS & ACCESSORIES
- HANDLEBARS & HAND CONTROLS
- FOOTPEGS & FOOT CONTROLS
- BODY
- GRAPHICS & SEATS
- SPROCKETS
- CHAINS
- BRAKES
- WHEELS & ACCESSORIES
- SUSPENSION
- ELECTRICAL & GAUGES
- LIGHTING
- ENGINE
- FUEL/AIR SYSTEMS
- HARDWARE & MERCHANDISING



1130-0844

COMPLETE BILLETPROOF® CLUTCH KITS

- Kit includes Billetproof® clutch cover, basket, inner hub, pressure plate, fiber and steel plates, and high-temperature clutch springs
- See page 1434 of the 2024 Parts Europe Offroad catalog for Hinson's full line of Complete Billetproof Clutch Kits

FITS MODEL	PART #	FITS MODEL	PART #	FITS MODEL	PART #
FANTIC		KAWASAKI		KTM (CONT)	
XXF 450 25	1130-0863	KX 250 21-25	1130-0634	SX-F 450 23-25	1130-0845
HUSQVARNA		KTM		EXC-F 350 23-25	1130-0844
TC 250 23-25	1130-0845	SX 250 23-25	1130-0845	YAMAHA	
FC 250 23-25	1130-0844	SX 300 23-25	1130-0845	YZ 450F 23-25	1130-0863
FC 350 23-25	1130-0844	SX-F 250 23-25	1130-0844	WR 450F 25	1130-0863
FC 450 23-25	1130-0845	SX-F 350 23-25	1130-0844		

FSC CLUTCH PLATE AND SPRING KIT

- Carbon fiber clutch plate kit
- Designed to enhance the performance of OEM clutch baskets, inner hubs and pressure plate or Hinson parts
- Tested and raced with all the same high-quality standards as all Hinson clutch components
- High production tolerances to perfectly mate Hinson clutch basket, enhancing clutch basket and plate life
- Clutch springs made from high temperature material to outlast any other springs on the market



- Manufactured using the highest quality materials
- See pages 1463-1464 of the 2024 Parts Europe Offroad catalog for Hinson's full line of FSC Clutch Plate and Spring Kits

FITS MODEL	PART #
KAWASAKI	
KX 250 21-24	1131-3938

PLATE KITS

- Designed to enhance the performance of OEM clutch baskets, inner hubs and pressure plate or Hinson parts
- Tested and raced with all the same high-quality standards as all Hinson clutch components
- High production tolerances to perfectly mate Hinson Clutch Basket, enhancing clutch basket and plate life
- Kits available in steel or fiber
- Fiber plate kit manufactured using high-quality aluminum baseplate and paper or cork friction material

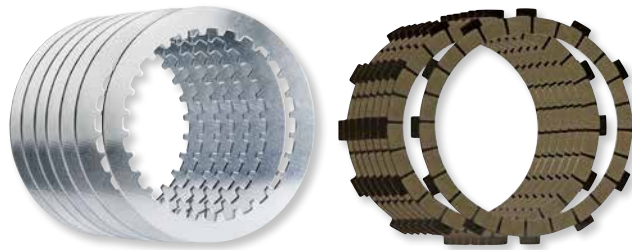

1131-3940

1131-3939

- Manufactured using the highest quality materials
- See pages 1464-1465 of the 2024 Parts Europe Offroad catalog for Hinson's full line of Plate Kits

FITS MODEL	STEEL PART #	# OF PLATES	FIBER PART #	# OF PLATES	FITS MODEL	STEEL PART #	# OF PLATES	FIBER PART #	# OF PLATES
GASGAS					HUSQVARNA				
MC 250/350F 21-25	1131-3940	8	1131-3939	7	FC 250/350 16-25	1131-3940	8	1131-3939	7
HONDA					KTM				
CRF 250R/RX 22-23	1131-3877	8	1131-3876	8	SX-F 250/350 16-25	1131-3940	8	1131-3939	7
					EXC-F 350 23-25	1131-3940	8	1131-3939	7

HI-TEMP CLUTCH SPRING KITS

- Developed with and recommended to enhance performance of OEM pressure plates as well as Hinson clutch baskets, inner hubs and pressure plates
- Made out of high-temperature steel to outlast anything else on the market
- Highly resistant to losing strength due to high heat from 4-strokes
- The correct stiffness to handle high horsepower engines
- Provides optimum hook-up with minimum heat buildup
- See page 1466 of the 2024 Parts Europe Offroad catalog for Hinson's full line of Hi-Temp Clutch Spring Kits



FITS MODEL	PART #	FITS MODEL	PART #
YAMAHA		YAMAHA (CONT)	
YZ 450F 23-25	1131-3953	WR 450F 24-25	1131-3953

DISCLAIMER: SEE PAGE 4 FOR IMPORTANT INFORMATION REGARDING CERTAIN WARRANTY AND EMISSION CONTROL REGULATION COMPLIANCE AND NOISE REGULATION INFORMATION.



SUPERCooler WATER PUMP COVER AND IMPELLER KITS

- Increases coolant flow at all rpm ranges
- Nautilus-style, cast aluminum impeller with a seamless hydrodynamic design
- Reduces cavitation and hydraulic friction
- Features high-capacity inlets
- See full line of Supercooler Water Pump Cover and Impeller Kits on pages 1496-1497 of the 2024 Parts Europe Offroad catalog



0934-7808



0934-7809

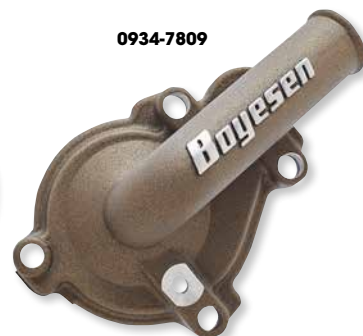

EXHAUST

LUGGAGE

BIKE STANDS & ACCESSORIES

HANDLEBARS & HAND CONTROLS

FOOTPEGS & FOOT CONTROLS

BODY

GRAPHICS & SEATS

SPROCKETS

CHAINS

BRAKES

WHEELS & ACCESSORIES

SUSPENSION

ELECTRICAL & GAUGES

LIGHTING

ENGINE

FUEL/AIR SYSTEMS

HARDWARE & MERCHANDISING

FITS MODEL	BLACK PART #	MAGNESIUM PART #
HUSQVARNA		
FC 250 23-24	0932-0306	0932-0307
FC 350 23	0932-0306	0932-0307
FE 350 24	0932-0306	0932-0307
KAWASAKI		
KX 450 24	0934-7808	0934-7809

FITS MODEL	BLACK PART #	MAGNESIUM PART #
KTM		
SX-F 250 23	0932-0306	0932-0307
SX-F 350 23-24	0932-0306	0932-0307
EXC-F 350 24	0932-0306	0932-0307



WATER PUMP COVERS

- Made from machined 6061 billet aluminum for that factory racing look
- Provides added durability over the stock cast OEM covers
- Uses stock impeller to reduce overall cost of other expensive aftermarket covers
- Comes with OEM-type gasket and brass washer drain plug for quick and easy installation
- Can be used with all OEM radiator hoses and clamps
- See page 1498 of the 2024 Parts Europe Offroad catalog for the full line of Moose Racing Water Pump Covers



FITS MODEL	PART #	FITS MODEL	PART #
GASGAS		KTM	
MC 125/250, EC 250/300 24	0940-2198	SX 250 23	0940-2198
HUSQVARNA		SX 300 23-24	0940-2198
TE 150 24	0940-2198	SX-F 250/350 23	0940-2198
TE 300 23-24	0940-2198		
TC 125/250 23-24	0940-2198	YAMAHA	
		YZ 250 00-23	0940-2197
		YZ 250X 16-23	0940-2197

0934-7513

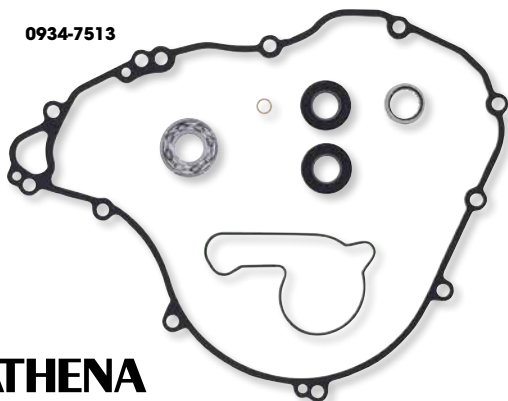

WATER PUMP GASKET KITS

- All kits include water pump gasket, clutch cover gasket, water pump shaft oil seals and washers and replacement bearings
- Kit contents will vary slightly based on application
- See page 1504 of the 2024 Parts Europe Offroad catalog for the full line of Athena Water Pump Gasket Kits

FITS MODEL	PART #	FITS MODEL	PART #
GASGAS		KAWASAKI	
EC 250F 21	0934-7513	KX 250 21-24	0934-7512
HUSQVARNA		KTM	
FE 250 20-21	0934-7513	EXC-F 250/350 20-21	0934-7513
FE 350 20-23	0934-7513		

WATER PUMP INSTALLATION AND REPAIR KIT

- Kit contains all components needed to properly replace water pump impeller or leaking water pump cover
- Quality seals, O-rings, bearings, crush washers and AFM Comet engine cover gaskets included for dependable, long-lasting usage
- Water pump impeller must be purchased separately
- See page 1504 of the 2024 Parts Europe Offroad catalog for the complete line of Comet Water Pump Installation and Repair Kits

FITS MODEL	PART #	FITS MODEL	PART #
YAMAHA		YAMAHA (CONT)	
YZ 450F 06-09	0934-7877	WR 450F 07-15	0934-7877

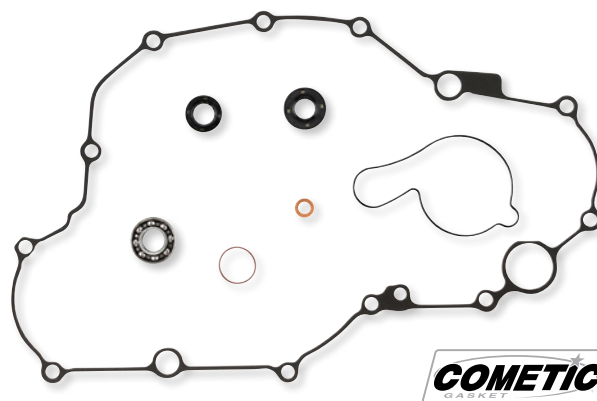

DISCLAIMER: SEE PAGE 4 FOR IMPORTANT INFORMATION REGARDING CERTAIN WARRANTY AND EMISSION CONTROL REGULATION COMPLIANCE AND NOISE REGULATION INFORMATION.

EXHAUST

LUGGAGE

BIKE STANDS & ACCESSORIES

HANDLEBARS & HAND CONTROLS

FOOTPEGS & FOOT CONTROLS

BODY

GRAPHICS & SEATS

SPROCKETS

CHAINS

BRAKES

WHEELS & ACCESSORIES

SUSPENSION

ELECTRICAL & GAUGES

LIGHTING

ENGINE

FUEL/AIR SYSTEMS



1902-1841



1902-1845

RADIATOR HOSE KITS AND CLAMP KITS

- High-performance silicone radiator hose kits
- Feature improved shape and thermal properties for better cooling - up to 5 °C
- Color-matched to manufacturer's production colors
- Silicon and reinforced fabrics to last longer than stock

- High-performance clamp kits (sold separately) feature marine-grade 18/8 stainless steel clamps with rounded edges, smooth inners and polished surfaces; contain all clamps necessary to complete installation of radiator hose kit
- See pages 1508-1510 of the 2024 Parts Europe Offroad catalog for the complete line of Samco Sport Radiator Hose Kits and Clamp Kits

FITS MODEL	# PIECES IN HOSE KIT	COLOR	HOSE KIT PART #	CLAMP KIT #
GASGAS				
MC 250 24-25	4	Blue	1902-1840	-
MC 250/350/450F 24-25	3	Blue	1902-1839	1902-1835
	3	Orange	1902-1845	1902-1835
EC 250/300 24-25	4	Blue	1902-1840	-
EC 250F/350F 24-25	3	Blue	1902-1839	1902-1835
	3	Orange	1902-1845	1902-1835
EC 350F 21-23	6	Blue	1902-1841	-
	6	Orange	1902-1846	-
EC 450F/500F 24-25	3	Blue	1902-1843	-
HUSQVARNA				
TC 250 23-25	4	Blue	1902-1840	-
FC 250 23-25	3	Blue	1902-1839	1902-1835
	3	Orange	1902-1845	1902-1835
FC 350 23	3	Blue	1902-1839	1902-1835
	3	Orange	1902-1845	1902-1835
FC 450 23-25	3	Blue	1902-1843	-
TE 150/250/300 24-25	4	Blue	1902-1840	-
FE 250/350 24-25	3	Blue	1902-1839	1902-1835
	3	Orange	1902-1845	1902-1835
FE 350 (OEM design) 20-23	6	Blue	1902-1841	-
	6	Orange	1902-1846	-
FE 501 24-25	3	Blue	1902-1843	-

FITS MODEL	# PIECES IN HOSE KIT	COLOR	HOSE KIT PART #	CLAMP KIT #
KAWASAKI				
KX 450F (OEM design) 24-25	6	Green	1902-1844	1902-1836
KTM				
SX 250 23-25	4	Blue	1902-1840	-
SX-F 250 Factory Edition 22	3	Blue	1902-1839	1902-1835
	3	Orange	1902-1845	1902-1835
SX-F 250/350 23-25	3	Blue	1902-1839	1902-1835
	3	Orange	1902-1845	1902-1835
SX-F 450 19-22	3	Blue	1902-1842	-
SX-F 450 23-25	3	Blue	1902-1843	-
EXC 250/300 24-25	4	Blue	1902-1840	-
EXC-F 250/350 24-25	3	Blue	1902-1839	1902-1835
	3	Orange	1902-1845	1902-1835
EXC-F 350 (OEM design) 20-23	6	Blue	1902-1841	-
	6	Orange	1902-1846	-
EXC-F 450 24-25	3	Blue	1902-1843	-
EXC-F 500 24-25	3	Blue	1902-1843	-
SMR 450 23-24-25	3	Blue	1902-1843	-
YAMAHA				
YZ 250F 24-25	4	Blue	1902-1848	1902-1838
YZ 450F (OEM design) 23-25	4	Blue	1902-1824	1902-1825



RADIATOR CAPS WITH TEMP GAUGE

- Improved radiator cap with a high performance design that includes a temperature gauge to easily monitor engine coolant temperatures
- High-quality aluminum alloy, silicone rubber, and zinc materials increase durability avoiding the common issue of fatigue in the rubber and spring preventing water leakage
- Built-in thermometer that displays coolant temperatures in both Celsius and Fahrenheit promoting safety before removing the cap



1903-0036

FITS MODEL	PART #	FITS MODEL	PART #	FITS MODEL	PART #
HONDA		HUSQVARNA		HUSQVARNA (CONT)	
CR 125R 00-08	1903-0036	TC 125 14-15	1903-0035	FE 250/350/450/501 15-16	1903-0035
CR 250R 00-08	1903-0036	TC 250 14-16	1903-0035	FE 501 13-14	1903-0035
CRF 250R 04-13	1903-0036	FC 250 14-15	1903-0035	FE 570 09-11	1903-0035
CRF 250X 04-13	1903-0036	FC 350 14-15	1903-0035	KAWASAKI	
CRF 450R 02-13	1903-0036	FC 450 14-15	1903-0035	KX 80 00	1903-0036
CRF 450X 05-13	1903-0036	TE 125/250/300 15-16	1903-0035	KX 85 01-13	1903-0036
XR 650R 00-08	1903-0036	TE 300 12-14	1903-0035	KX 125 00-05	1903-0036

DISCLAIMER: SEE PAGE 4 FOR IMPORTANT INFORMATION REGARDING CERTAIN WARRANTY AND EMISSION CONTROL REGULATION COMPLIANCE AND NOISE REGULATION INFORMATION.



RADIATOR CAPS WITH TEMP GAUGE (CONT)

FITS MODEL	PART #
KAWASAKI (CONT)	
KX 250 00-07	1903-0036
KX 250 12-13	1903-0036
KX 450 12-13	1903-0036
KX 250F 04-13	1903-0036
KX 450F 06-13	1903-0036
KLX 250 95-96	1903-0036
KLX 250R 95-96	1903-0036
KLX 450R 08-12	1903-0036
KLX 650 95-96	1903-0036
KTM	
SX 85 17/14 18-24	1903-0037
SX 85 19/16 BW 18-24	1903-0037
SX 125/150 16-22	1903-0037
SX 125 10-15	1903-0035
SX 150 11-15	1903-0035
SX 250 10-16	1903-0035
SX 250 17-22	1903-0037
SX-F 250 08-15	1903-0035
SX-F 250/350/450 16-22	1903-0037
SX-F 350 11-15	1903-0035
SX-F 450 08-15	1903-0035
SX-F 505 08	1903-0035
SX-F Carioli Replica 350 12	1903-0035
SX-F Factory Edition 450 13	1903-0035
SX-F Herlings Replica 450 19	1903-0037
SX-F Prado 250 20	1903-0037
SX-F Roczen Replica 250 12	1903-0035

FITS MODEL	PART #
KTM (CONT)	
SX-F Troy Lee Designs 250 21	1903-0037
EXC 150 20-23	1903-0037
EXC 200/250 10-16	1903-0035
EXC 250/300 18-22	1903-0037
EXC 300 10-16	1903-0035
EXC 400 09-11	1903-0035
EXC 450 09-16	1903-0035
EXC 500 12-16	1903-0035
EXC 530 09-11	1903-0035
EXC Erzbergrodeo 300 20-23	1903-0037
EXC Six Days 250 17, 21-22	1903-0037
EXC Six Days 250 10-16	1903-0035
EXC Six days 300 17-22	1903-0037
EXC Six Days 300 12-16	1903-0035
EXC Six Days 450 09-16	1903-0035
EXC Six Days 500 12-16	1903-0035
EXC-F 250 08-16	1903-0035
EXC-F 250/350/450/500 17-23	1903-0037
EXC-F 350 12-16	1903-0035
EXC-F Factory Edition 350 15	1903-0035
EXC-F Factory Edition 350 22	1903-0037
EXC-F Six Days 250 08-15	1903-0035
EXC-F Six Days 300 10-11	1903-0035
EXC-F Six Days 350 12-16	1903-0035
EXC-F Six Days 350 17-23	1903-0037
EXC-F Six Days 450 17-23	1903-0037
EXC-F Six Days 500 17, 21-23	1903-0037

FITS MODEL	PART #
KTM (CONT)	
RC4 R 20	1903-0037
RC4 R 22-23	1903-0037
EXC-R 450 08	1903-0035
EXC-R 530 08	1903-0035
SXS-F 250 08	1903-0035
SXS-F 450 08	1903-0035
SUZUKI	
RM 80 00-01	1903-0036
RM 85 02-12	1903-0036
RM 125 00-07	1903-0036
RM 250 00-08	1903-0036
RM-Z 250 04-13	1903-0036
RM-Z 450 05-13	1903-0036
DR-Z 400 00-04	1903-0036
DR-Z 400S 00-13	1903-0036
RMX 450Z 10	1903-0036
YAMAHA	
YZ 80 00-01	1903-0036
YZ 85 02-13	1903-0036
YZ 250 95-12	1903-0036
YZ 250F 02-12	1903-0036
YZ 426F 00-02	1903-0036
YZ 450F 03-12	1903-0036
WR 250F 01-13	1903-0036
WR 250R 08-13	1903-0036
WR 250X 08-11	1903-0036
WR 400F 00-13	1903-0036



MACHINED OIL FILTER COVERS

- CNC machined covers made from 6061-T6 aluminum
- Black anodized finish for added looks and appeal
- Aluminum cover helps dissipate added heat from engine oil
- Lightweight, durable design
- See page 1478 of the 2024 Parts Europe Offroad catalog for the full line of Moose Racing Machined Oil Filter Covers

FITS MODEL	PART #
GASGAS	
MC 250F 21-22	0940-2196
MC 350F 23	0940-2196
EC 250F/350F 21-23	0940-2196
HUSQVARNA	
Enduro 701 16-21	0940-2194



OIL FILLER CAP

- CNC machined billet covers made of 6061-T6 aluminum
- Anodized finish matched to manufacturer's color for added looks and appeal
- Lightweight and durable design
- See page 1480 of the 2024 Parts Europe Offroad catalog for the full line of Moose Oil Filler Caps

FITS MODEL	COLOR	PART #
BETA		
RR 2T 125/300, RR 250, Xtrainer 300 18-21	Red	0950-1033
RR 2T 200 19-21	Red	0950-1033
Xtrainer 250, RR 2T 300 18-19	Red	0950-1033



ENGINE PLUGS FOR YAMAHA YZ 450F 23-25

- High-quality CNC-machined anodized engine oil plugs with blue finish
- For the full line of SCAR Engine Plugs see page 1483 of the 2024 Parts Europe Offroad catalog

DESCRIPTION	PART #
Engine plugs	0940-2182



DISCLAIMER: SEE PAGE 4 FOR IMPORTANT INFORMATION REGARDING CERTAIN WARRANTY AND EMISSION CONTROL REGULATION COMPLIANCE AND NOISE REGULATION INFORMATION.

EXHAUST

LUGGAGE

BIKE STANDS & ACCESSORIES

HANDLEBARS & HAND CONTROLS

FOOTPEGS & FOOT CONTROLS

BODY

GRAPHICS & SEATS

SPROCKETS

CHAINS

BRAKES

WHEELS & ACCESSORIES

SUSPENSION

ELECTRICAL & GAUGES

LIGHTING

ENGINE

FUEL/AIR SYSTEMS

HARDWARE & MERCHANDISING

EXHAUST

LUGGAGE

BIKE STANDS & ACCESSORIES

HANDLEBARS & HAND CONTROLS

FOOTPEGS & FOOT CONTROLS

BODY

GRAPHICS & SEATS

SPROCKETS

CHAINS

BRAKES

WHEELS & ACCESSORIES

SUSPENSION

ELECTRICAL & GAUGES

LIGHTING

ENGINE

FUEL/AIR SYSTEMS

HARDWARE & MERCHANDISING

1020-4230



POWER VISION TOKEN

- With this token for your Dynojet Power Vision, you can tune an additional vehicle on the same device
- This is perfect for dealers, as well as enthusiasts and families who have multiple vehicles to maintain
- Works with all Power Vision, Power Vision 3 and Power Vision 4
- Can be used on one vehicle an unlimited number of times, but not on multiple vehicles

DESCRIPTION	PART #
Single token	1020-4230
10 pk.	1020-4231

1020-4222



POWER VISION 3 FOR HONDA

- Flash performance tunes via OEM diagnostic connector, no need to remove and send out ECU
- Display vehicle data channels in real-time
- Weather-resistant for use in all conditions
- High-contrast display, viewable in direct sunlight
- Fueling revised for maximum power and torque
- Spark timing optimized for 91-93 octane fuel
- Rev limit raised
- Speed limit raised
- See page 1515 of the 2024 Parts Europe Offroad catalog for the complete line of Dynojet Power Vision 3

NOTE: All Power Vision returns and/or adjustments must be made directly with Dynojet Research.

FITS MODEL	PART #	FITS MODEL	PART #
CRF 110F 19-20	1020-4222	CRF 125F 19-20	1020-4223

1020-4176



CONTROL UNITS RX1 PRO BASIC KITS

- Designed to exploit everything your bike has to offer ensuring better power delivery and timing at any engine speed
- Gives your bike a smoother ride, more immediate ignition and greater speed on the track
- Mounts quickly and easily directly on to the bike's main wiring without having to modify the electrical system
- Replaces OEM ECU
- Quickly processes input data coming from the CPS (Cam Position Sensor), TPS (Throttle Position Sensor), MAP (Manifold Absolute Pressure sensor), IAT (Intake Air Temperature sensor) and ECT (Engine Coolant Temperature sensor)
- Adjusts the ignition and carburetion accordingly in all weather conditions and at any altitude
- Comes with two pre-installed racing mappings which get the best out of every standard engine with a racing exhaust installed
- GPA Traction Control technology can be adjusted on ten different intervention levels for each map
- Compatible with data acquisition systems like GET SL1 via CAN bus (sold separately)
- Allows any rider of any level to easily customize the main mapping parameters like carburetion and ignition times in total safety using the app with GET WiFi-Com (sold separately)
- Custom builders can fine-tune engine using the Maya programming software (sold separately)

1020-4182



SX1 PRO KITS

- Designed to optimize the potential of your bike while maintaining the same level of reliability and improving power
- Multifunction control SX1 controller and SX1 Connect WiFi module included in the kit
- Optimal management of advance degrees and injection times in all weather conditions and at all altitude levels
- Plug-and-play installation
- Installs directly on the main wiring of the bike without modifying the electrical system
- Supplied with two racing maps developed and approved after intense tests with the best AMA and MXGP teams
- Each map can be modulated via the GPA Traction Control technology on ten different intervention levels
- Activates the electronic Launch Control system for maximum speed when cornering and starting
- GPA Switch PART #1020-4161 works with SX1 Pro units, mounting on your handlebars and allows modulation in real-time of up to ten levels of GPA Traction Control (sold separately)

DISCLAIMER: SEE PAGE 4 FOR IMPORTANT INFORMATION REGARDING CERTAIN WARRANTY AND EMISSION CONTROL REGULATION COMPLIANCE AND NOISE REGULATION INFORMATION.



CONTROL UNITS (CONT)

CONTROL UNITS

FITS MODEL	RX1 PRO BASIC	SX1 PRO
GASGAS		
MC 125 24	-	1020-4182
MC 250F 21-23	1020-4170	-
MC 250F 24	1020-4171	1020-4181
MC 350F 21-23	1020-4172	-
MC 350F 24	1020-4173	1020-4193
MC 450F 21-23	1020-4174	-
MC 450F 24	1020-4175	1020-4192
EC 250	-	1020-4184
EC 300 24	-	1020-4183
EC 250F 21-23	1020-4176	-
EC 250F 24	-	1020-4198
EC 350F 21-23	1020-4177	-
EC 350F 24	-	1020-4197
EC 450F 24	-	1020-4196
HONDA		
CRF 250R 22-24	1020-4163	-
CRF 250R 24	-	1020-4187
CRF 450R 23-24	1020-4162	-
CRF 450R 24	-	1020-4186
HUSQVARNA		
TC 125 23-24	-	1020-4182
TC 250 23-24	-	1020-4181
FC 250 19-22	1020-4170	-
FC 250 23-24	1020-4171	-
FC 350 19-22	1020-4172	-
FC 350 23-24	1020-4173	-

FITS MODEL	RX1 PRO BASIC	SX1 PRO
HUSQVARNA (CONT)		
FC 350 24	-	1020-4193
FC 450 19-22	1020-4174	-
FC 450 23-24	1020-4175	-
FC 450 24	-	1020-4192
TE 150 24	-	1020-4185
TE 250 24	-	1020-4184
TE 300 24	-	1020-4183
FE 250 20-23	1020-4176	-
FE 250 24	-	1020-4198
FE 350 20-23	1020-4177	-
FE 350 24	-	1020-4197
FE 450 20-23	1020-4178	-
FE 450 24	-	1020-4196
FE 501 20-23	1020-4179	-
FE 501 24	-	1020-4195
KAWASAKI		
KX 250 23-24	1020-4167	-
KX 250 24	-	1020-4189
KX 450 22-23	1020-4166	-
KX 450 24	-	1020-4188
KTM		
SX 125 23-24	-	1020-4182
SX 250 23-24	-	1020-4181
SX 300 23-24	1020-4180	-
SX-F 250 19-22	1020-4170	-
SX-F 250 23-24	1020-4171	-

FITS MODEL	RX1 PRO BASIC	SX1 PRO
KTM (CONT)		
SX-F 250 24	-	1020-4194
SX-F 350 19-22	1020-4172	-
SX-F 350 23-24	1020-4173	-
SX-F 350 24	-	1020-4193
SX-F 450 19-22	1020-4174	-
SX-F 450 23-24	1020-4175	-
SX-F 450 24	-	1020-4192
EXC 150 24	-	1020-4185
EXC 250 24	-	1020-4184
EXC 300 24	-	1020-4183
EXC-F 250 20-23	1020-4176	-
EXC-F 250 24	-	1020-4198
EXC-F 250 24	-	1020-4197
EXC-F 350 20-23	1020-4177	-
EXC-F 450 20-23	1020-4178	-
EXC-F 450 24	-	1020-4196
EXC-F 500 20-23	1020-4179	-
EXC-F 500 24	-	1020-4195
SUZUKI		
RM-Z 250 19-24	1020-4165	-
RM-Z 450 20-24	1020-4164	-
YAMAHA		
YZ 250F 21-23	1020-4169	-
YZ 250F 24	-	1020-4191
YZ 450F 23-24	1020-4168	-
YZ 450F 24	-	1020-4190

GPA SWITCHES

FITS MODEL	PART #	FITS MODEL	PART #
Map 1-2 switch	0616-0437	GPA switch for SX1 Pro	1020-4161



1003-1448

AIR CUT-OFF VALVE REBUILD KITS

- Kits include all necessary parts to rebuild the air cut-off valve circuit
- Models with multiple carburetors include components to repair all carburetors
- Kits include necessary O-rings, diaphragm, spring, screws
- Improperly functioning air cut-off valves can stick open or closed, causing popping on deceleration or poor running conditions
- See page 1524 of the 2024 Parts Europe Offroad catalog for the complete line of Moose Racing air cut-off valve rebuild kits

FITS MODEL	PART #	FITS MODEL	PART #	FITS MODEL	PART #
YAMAHA					
TT-R125 Drum Brake 00-03	1003-1448	YAMAHA (CONT)		TT-R225 99-04	1003-1449
TT-R125E Drum Brake 03-09	1003-1448	TT-R125L Disc Brake 00-08	1003-1448	TT-R125LE Disc Brake 03-23	1003-1448



GENUINE MIKUNI JET NEEDLES

- Jet needles control the fuel mixture in the mid-range throttle position
- Use charting to verify dimensions in millimeters
- Measurements not provided by Mikuni
- Fitments include several Mikuni VM models and some OE Mikuni carburetors
- Sold each
- See page 1531 of the 2024 Parts Europe Offroad catalog for the complete line of Genuine Mikuni Jet Needles

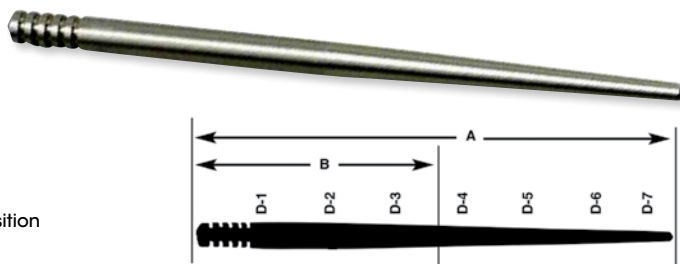

MIKUNI #	PART #	DESCRIPTION	MIKUNI #	PART #	DESCRIPTION	MIKUNI #	PART #	DESCRIPTION
J8-6EJ12-60	6EJ12-60	Leaner	J8-6EJ12-57	6EJ12-57	Rich	J8-6EJ12-56	6EJ12-56	Richest

DISCLAIMER: | SEE PAGE 4 FOR IMPORTANT INFORMATION REGARDING CERTAIN WARRANTY AND EMISSION CONTROL REGULATION COMPLIANCE AND NOISE REGULATION INFORMATION.

- EXHAUST
- LUGGAGE
- BIKE STANDS & ACCESSORIES
- HANDLEBARS & HAND CONTROLS
- FOOTPEGS & FOOT CONTROLS
- BODY
- GRAPHICS & SEATS
- SPROCKETS
- CHAINS
- BRAKES
- WHEELS & ACCESSORIES
- SUSPENSION
- ELECTRICAL & GAUGES
- LIGHTING
- ENGINE
- FUEL/AIR SYSTEMS
- HARDWARE & MERCHANDISING

EXHAUST

LUGGAGE

BIKE STANDS & ACCESSORIES

HANDLEBARS & HAND CONTROLS

FOOTPEGS & FOOT CONTROLS

BODY

GRAPHICS & SEATS

SPROCKETS

CHAINS

BRAKES

WHEELS & ACCESSORIES

SUSPENSION

ELECTRICAL & GAUGES

LIGHTING

ENGINE

FUEL/AIR SYSTEMS

HARDWARE & MERCHANDISING



FUEL PUMP MODULES

- Includes all necessary parts to replace the fuel pump module
- Economical solution for restoring lost performance or non-performing fuel pump
- Pump draws less current than OEM pump while maintaining the same flow rate and working pressure reducing working temperatures and increasing unit life
- Includes complete module, retaining nut and gasket
- See page 1537 of the 2024 Parts Europe Offroad catalog for additional All Balls fuel pump modules



FITS MODEL	PART #	FITS MODEL	PART #	FITS MODEL	PART #
HUSABERG		HUSABERG (CONT)		KTM	
FE 450 09-11	1009-0187	FS 570 10-11	1009-0187	SX-F 250/350 11-12	1009-0187
FE 570 09-11	1009-0187	FX 450 10-11	1009-0187		



FUEL PUMP REBUILD KIT

- Comes ready for plug-and-play installation
- Economical solution for restoring lost performance or non-performing fuel pump
- Includes all necessary components to rebuild the OEM fuel pump module
- Includes necessary pump, filter, hose(s), clamp(s) and wiring harness as necessary per model
- See page 1537 of the 2024 Parts Europe Offroad catalog for additional All Balls fuel pump rebuild kits



FITS MODEL	PART #	FITS MODEL	PART #	FITS MODEL	PART #
HONDA		HONDA (CONT)		HONDA (CONT)	
CRF 110F/250F 19-23	1009-0188	CRF 250L Rally/ABS 17-20	1009-0188	CB 300R ABS 19-23	1009-0188
CRF125F/FB Big Wheel 19-23	1009-0188	CRF 300L/ABS/Rally 21-22	1009-0188		
CRF 250L/ABS 17-20	1009-0188	CB 300R 19	1009-0188		



EFI FUEL PUMP REBUILD KITS

- Kits include all necessary parts to rebuild the OEM fuel pump module
- Kits include: pump, hoses, clamps, wiring harness and filter if needed
- Restore lost performance or non-functioning fuel pump with this economical solution
- Kits come ready for plug-and-play installation
- See page 1368 of the 2024 Parts Europe Offroad catalog for the complete line of Moose Racing EFI fuel pump rebuild kits



FITS MODEL	PART #	FITS MODEL	PART #	FITS MODEL	PART #
GASGAS		HUSQVARNA		KTM	
MC 250 24	1009-0192	TC 125 23-24	1009-0192	SX 125 24	1009-0192
MC 250F 24	1009-0192	TC 125 Heritage Edition 23	1009-0192	SX 250 24	1009-0192
MC 250F Factory Edition 23-24	1009-0192	TC 250 23-24	1009-0192	SX 300 24	1009-0192
MC 350F 24	1009-0192	TC 250 Heritage Edition 23	1009-0192	SX-F 250 24	1009-0192
MC 450F 24	1009-0192	FC 250 23-24	1009-0192	SX-F 250 Factory Edition 24	1009-0192
MC 450F Factory Edition 23-24	1009-0192	FC 250 Heritage Edition 23	1009-0192	SX-F 350 24	1009-0192
EC 250 24	1009-0192	FC 350 23-24	1009-0192	SX-F 450 24	1009-0192
EC 300 24	1009-0192	FC 350 Heritage Edition 23	1009-0192	SX-F 450 Factory Edition 22-24	1009-0192
EC 450F 24	1009-0192	FC 450 23-24	1009-0192	EXC 150 24	1009-0192
EW 500F 24	1009-0192	FC 450 Heritage Edition 23	1009-0192	EXC 250 24	1009-0192
HONDA		TE 150 24		EXC 300 24	
CRF 250R 22-24	1009-0191	TE 300 24	1009-0192	EXC-F 350 24	1009-0192
CRF 450R 21-24	1009-0191	FE 450 24	1009-0192	EXC-F 500 24	1009-0192
CRF 450RWE 21-24	1009-0191			EXC-F 500 Six Days 24	1009-0192
				EXC Hardenduro 300 24	1009-0192

DISCLAIMER: SEE PAGE 4 FOR IMPORTANT INFORMATION REGARDING CERTAIN WARRANTY AND EMISSION CONTROL REGULATION COMPLIANCE AND NOISE REGULATION INFORMATION.



VFORCE4X REED VALVES AND REPLACEMENT REEDS

- Advanced reed petal resin system, carbon fiber and lay-up
- Pre-curved reed petal ensures better seal at the tip
- Wider reed cage for maximum airflow
- Combined reed tip area is increased by 10,5% for better airflow
- Airfoil shape added to cage tip to increase velocity from the outer ports
- Long reed stops added to progressively slow reed petal tip velocity for increased petal durability
- Reduced frontal area of the central wing combined with a more aerodynamic shape
- Replacement reeds sold one set per reed cage

FITS MODEL	REED VALVE PART #	REPL. REED PETAL PART #
GASGAS		
MC 125/250/300 24-25	1008-0361	1008-0364
EC 250 22-25	1008-0361	1008-0364
EC 300 22-25	1008-0361	1008-0364
HUSQVARNA		
TC 125/250 24-25	1008-0361	1008-0364
TC 150/300 25	1008-0361	1008-0364
TE 150/i 18-25	1008-0361	1008-0364
TE 250/i/300/i 18-23	1008-0361	1008-0364

1008-0361



FITS MODEL	REED VALVE PART #	REPL. REED PETAL PART #
KTM		
SX 125/250 23-25	1008-0361	1008-0364
SX 150 25	1008-0361	1008-0364
SX 300 23-25	1008-0361	1008-0364
EXC 300 21-23	1008-0361	1008-0364
YAMAHA		
YZ 250 97-24	1008-0360	1008-0363
YZ 250X 16-24	1008-0360	1008-0363



VFORCE3 REED VALVE AND REPLACEMENT REED

- Snap-together cage uses symmetrical reed petals, eliminating the need for different "inner" and "outer" replacement petals
- Reed tip shape accelerates air mixture, ensuring increased airflow for increased horsepower
- Innovative design completely eliminates need for screws
- When ordering replacement reeds, order one set per reed cage

1008-0362



FITS MODEL	REED VALVE PART #	REPL. REED PETAL PART #
HONDA		
CR 500R 85-01	1008-0362	1008-0365



EAR CLAMP ASSORTMENT KIT

- 80 pieces total in various sizes
- Includes jaw pincer plier tool
- Clamps are made from SS304 Stainless Steel for improved durability and corrosion resistance
- Smooth edged clamp design prevents/minimizes damage to hose
- 7 mm wide, 0.6 mm thick bank provides concentrated seal compression
- 360° stepless design with no gaps on inner surface for maximized clamping pressure

DESCRIPTION	PART #
Ear clamp assortment kit	2402-0295



DISCLAIMER: SEE PAGE 4 FOR IMPORTANT INFORMATION REGARDING CERTAIN WARRANTY AND EMISSION CONTROL REGULATION COMPLIANCE AND NOISE REGULATION INFORMATION.

EXHAUST

LUGGAGE

BIKE STANDS & ACCESSORIES

HANDLEBARS & HAND CONTROLS

FOOTPEGS & FOOT CONTROLS

BODY

GRAPHICS & SEATS

SPROCKETS

CHAINS

BRAKES

WHEELS & ACCESSORIES

SUSPENSION

ELECTRICAL & GAUGES

LIGHTING

ENGINE

FUEL/AIR SYSTEMS

HARDWARE & MERCHANDISING

EXHAUST

LUGGAGE

BIKE STANDS & ACCESSORIES

HANDLEBARS & HAND CONTROLS

FOOTPEGS & FOOT CONTROLS

BODY

GRAPHICS & SEATS

SPROCKETS

CHAINS

BRAKES

WHEELS & ACCESSORIES

SUSPENSION

ELECTRICAL & GAUGES

LIGHTING

ENGINE

FUEL/AIR SYSTEMS

HARDWARE & MERCHANDISING

1011-4800



1011-4796



STANDARD AND BACKFIRE FILTERS

- Twin Air dual-stage filters are the choice of top factory teams and riders worldwide
- Dual-bonded foam design filters out even the smallest dirt particles, while allowing more airflow than two separate layer filters (flow bench proven)
- Flat foam sealing ring provides a secure seat against the airbox, even in the worst riding conditions
- Twin Air filters are slightly smaller than stock, making them easier to change while increasing dead air space around the filter for better performance
- Backfire triple-stage filters include a laminated layer of backfire-retardant foam
- Air filter cages available separately for some models
- Supermoto filters available for select models are built with Twin Air's Dust Cover material for added airflow
- See pages 1559-1571 of the 2024 Parts Europe Offroad catalog for the complete line of Twin Air filters, dust covers, airbox covers and air filter kits

FACTORY PRE-OILED AIR FILTERS

- The same factory treatment that race teams and OEMs receive is now available for all Twin Air users
- Filters are pre-oiled with Twin Air Bio-Foam Filter Oil using our state-of-the-art filter oiling machines to provide the ultimate consistency in pore coverage
- Same industry-leading Twin Air Filter pre-oiled for your convenience
- Resealable bag included
- Available in standard Twin Air replacement filters and PowerFlow Twin Air replacement filters
- PowerFlow replacement filters include Backfire Filter

1011-4956



DUST/RAIN/ GRAND-PRIX COVERS

- Fits over the Twin Air filter when riding in severe conditions such as heavy dust and sand
- Coarse foam pre-filter will act as an additional layer of protection and extend the service time between filter cleanings
- Dust cover is a single-stage foam filter
- Rain coat is a single-stage foam filter with material for extremely wet conditions
- Grand-Prix cover is a filter sock with nylon

1011-4865



POWERFLOW KITS

- 2-stroke kits include a Twin Air filter and a rigid, lightweight, billet aluminum cage that replaces the flimsy plastic stock cage and provides a tight seal to the airbox
- 4-stroke kits replace the air-restricting stock backfire screen with a screen that has a special backfire-resistant layer of foam laminated to the inside
- Include a rigid, lightweight billet aluminum cage

AIRBOX COVERS

- Remove the air filter and pressure wash the inside of the airbox by covering the carb inlet with a watertight cap
- Made of PVC with a rubber sealing ring
- Top screw included

1011-4861



FITS MODEL	STANDARD AIR FILTERS	BACKFIRE AIR FILTERS	PRE-OILED AIR FILTERS	POWERFLOW KITS	REPL. FILTERS FOR POWERFLOW KITS	REPL. PRE-OILED FILTERS FOR POWERFLOW KITS	DUST COVERS/ GRAND-PRIX COVERS	AIRBOX COVERS	RAIN COVERS
FANTIC									
XX/XE 125/250 23-24	1011-4981	-	1011-4975	1011-4976	-	-	-	-	-
XXF 450 24	-	-	-	-	-	-	-	1011-4923 ⁵	-
GASGAS									
MC 50 24-25	1011-4800	-	1011-4860	-	-	-	-	1011-4861	-
MC 65 24-25	1011-4801	-	1011-4799	-	-	-	1011-4956 ²	1011-4863	-
MC 125/250, EC 250/300 24-25	-	-	1011-4803	-	-	-	-	-	-
HONDA									
CRF 250R/450R 25	1011-4961	-	-	-	-	-	1011-4959 ²	1011-4960	-
CRF 300L 21-24	1011-4899 ⁴	1011-4897	1011-4898	-	-	-	-	-	-
HUSQVARNA									
TC 50 24-25	1011-4800	-	1011-4860	-	-	-	-	1011-4861	-
TC 65 24-25	1011-4801	-	1011-4799	-	-	-	1011-4956 ²	1011-4863	-
TC 125/250 23-25	-	-	1011-4803	-	-	-	-	-	-
TC 150/300 25	-	-	1011-4803	-	-	-	-	-	-
FC 250/350/450 23-25	-	-	-	-	-	1011-4796 ¹	-	-	-
TE 125/250/300 24-25	-	-	1011-4803	-	-	-	-	-	-
KAWASAKI									
KX 250 25	1011-4804	-	1011-4795	-	-	-	1011-4957 ²	-	-
KX 450 24-25	1011-4804	-	1011-4795	1011-4865	1011-4864 ¹	1011-4926 ¹	1011-4962	1014-0387	-
	-	-	-	-	-	-	1011-4957 ²	1011-4790 ³	-
	-	-	-	-	-	-	1011-4958 ^{2,3}	-	-
KOVE									
450 Rally 23-24	1011-4963	-	-	-	-	-	-	-	-

¹ Backfire filter.
² GP dust cover.

³ For PowerFlow kit only.
⁴ Includes plastic cage.

⁵ Powercover.

DISCLAIMER: SEE PAGE 4 FOR IMPORTANT INFORMATION REGARDING CERTAIN WARRANTY AND EMISSION CONTROL REGULATION COMPLIANCE AND NOISE REGULATION INFORMATION.



STANDARD, BACKFIRE AND PRE-OILED AIR FILTERS, POWERFLOW KITS, DUST/RAIN/GRAND-PRIX COVERS AND AIRBOX COVERS (CONT)

FITS MODEL	STANDARD AIR FILTERS	BACKFIRE AIR FILTERS	PRE-OILED AIR FILTERS	POWERFLOW KITS	REPL. FILTERS FOR POWERFLOW KITS	REPL. PRE-OILED FILTERS FOR POWERFLOW KITS	DUST COVERS/ GRAND-PRIX COVERS	AIRBOX COVERS	RAIN COVERS
KTM									
SX 50 24-25	1011-4800	-	1011-4860	-	-	-	-	1011-4861	-
SX 65 24-25	1011-4801	-	1011-4799	-	-	-	-	1011-4863	-
SX 150 25	-	-	1011-4803	-	-	-	-	-	-
SX 125/250/300 23-25	-	-	1011-4803	-	-	-	-	-	-
SX-F 250/350/450 23-25	-	-	-	-	-	1011-4796 ¹	-	-	-
EXC 150/250/300 24-25	-	-	1011-4803	-	-	-	-	-	-
SHERCO									
ST 125/250/300 10-11	1011-4952	-	-	-	-	-	-	-	-
ST 125/250/300 12-15	1011-4953	-	-	-	-	-	-	-	-
ST 125/250/300 24	1011-4924	-	1011-4925	-	-	-	-	-	-
SEF 250/300/450/500 25	1011-4982	1011-4977	1011-4978 ¹	-	-	-	1011-4979	-	-
	-	-	-	-	-	-	1011-4980 ²	-	-
TRIUMPH									
TF 250-X 24-25	1011-4793	-	1011-4866	-	-	-	-	-	-
TRS									
Trial 250/280/300 16-20	1011-4944	-	-	-	-	-	-	-	-
YAMAHA									
YZ 250F 24-25	-	-	-	-	-	-	-	1011-4923 ⁵	-
YZ 450F 23-25	-	-	-	-	-	-	-	1011-4923 ⁵	-
WR 250F 25	-	-	-	-	-	-	-	1011-4923 ⁵	-
WR 450F 24-25	-	-	-	-	-	-	-	1011-4923 ⁵	-

¹ Backfire filter.

² GP dust cover.

⁵ Powercover.



AIR FILTERS

- Bonded, two-layer foam designed for maximum protection and airflow
- Coarse outer foam traps large particles while fine inner foam catches the finest dust
- Flexible glue is used on all seams to prevent cracking
- Super Seal neoprene ring keeps out water and provides a no-grease seal
- Exclusive 0,65 foam
- Precision Pre-Oiled air filters are prepared by a high-technology machine that pre-oils filters to perfection
- With the precision pre-oiled air filter, there is no excess oil to rob horsepower, and no dry spots endangering your engine

FITS MODEL	STANDARD PART #	PRE-OILED PART #
GASGAS		
MC 50 24-25	1011-4921	-
MC 65 24-25	1011-4922	-
HUSQVARNA		
TC 50 24-25	1011-4921	-
TC 65 24-25	1011-4922	-



AIR FILTERS

- Unsurpassed in airflow, dirt stopping and overall performance
- Two-stage air filters come apart for maximum airflow and ultimate cleaning
- Most filters feature the Ultra Seal grease groove on the sealing surface
- Each fits in stock air box exactly like OEM filter
- Clean easily with grease-cutting dishwashing detergent; just clean, oil and reuse indefinitely

FITS MODEL	PART #	FITS MODEL	PART #
BETA			
RR 2T 125/200/250/300/350/390/430/480 24	1011-4785	BMW (CONT)	
		F800GS 07-14	1011-2028
BMW			
F650GS Twin 09-12	1011-2028	790 Adventure R 19	1011-4407

1011-4921



- Oiled with high tack and bio-friendly, FLAME RESISTANT Moose Racing Super Seal Filter Oil
- Save the hassle and get it done for only a dollar over the cost of regular Moose Racing Air Filters
- Includes re-sealable filter bag
- See pages 1572-1574 of the 2024 Parts Europe Offroad catalog for Moose Racing's complete line of air filters

FITS MODEL	STANDARD PART #	PRE-OILED PART #
KAWASAKI		
KX 450 24-25	1011-4920	-
KTM		
SX 50 24-25	1011-4921	-
SX 65 24-25	1011-4922	-
YAMAHA		
YZ 250F 24-25, YZ 450F 23-25	-	1011-4969

1011-4785



1011-4407



DISCLAIMER: SEE PAGE 4 FOR IMPORTANT INFORMATION REGARDING CERTAIN WARRANTY AND EMISSION CONTROL REGULATION COMPLIANCE AND NOISE REGULATION INFORMATION.

- EXHAUST
- LUGGAGE
- BIKE STANDS & ACCESSORIES
- HANDLEBARS & HAND CONTROLS
- FOOTPEGS & FOOT CONTROLS
- BODY
- GRAPHICS & SEATS
- SPROCKETS
- CHAINS
- BRAKES
- WHEELS & ACCESSORIES
- SUSPENSION
- ELECTRICAL & GAUGES
- LIGHTING
- ENGINE
- FUEL/AIR SYSTEMS
- HARDWARE & MERCHANDISING

EXHAUST

LUGGAGE

BIKE STANDS & ACCESSORIES

HANDLEBARS & HAND CONTROLS

FOOTPEGS & FOOT CONTROLS

BODY

GRAPHICS & SEATS

SPROCKETS

CHAINS

BRAKES

WHEELS & ACCESSORIES

SUSPENSION

ELECTRICAL & GAUGES

LIGHTING

ENGINE

FUEL/AIR SYSTEMS

HARDWARE & MERCHANDISING



OE REPLACEMENT OFFROAD HIGH-FLOW AIR FILTER™

FOR HONDA CRF 250F 19-24

- Designed to increase airflow and performance
- Pleated media creates a large surface area
- Strong, pliable molded flange and seals
- Fuel-management modifications are not required for increased performance
- Washable and reusable, pre-oiled and ready to ride
- Cleans up easily with K&N® filter cleaners
- See page 1576 of the 2024 Parts Europe Offroad catalog for the complete line of K&N High-Flow air filters



FITS MODEL

High-Flow air filter™

PART

1011-4966



UNIVERSAL CLAMP-ON AIR FILTER

- Round tapered shape
- Centered flange type
- Chrome end cap
- Clamp directly to the carburetor throat, replacing the stock airbox and filter element
- Pleated design increases surface area air flow
- Match the outer diameter (OD) of your carb throat with the inner diameter (ID) of the filter (given in inches and millimeters)
- Flange ID: 64 mm (2 1/2")
- Base OD: 118 mm (4 82/125")
- Top OD: 89 mm (3 1/2")
- Filter length: 151 mm (6")
- Flange length: 21 mm (4/5")
- See pages 1576-1577 of the 2024 Parts Europe Offroad catalog for the complete line of K&N® universal clamp-on air filters



DESCRIPTION

Universal clamp-on air filter

PART

1011-4501



FOAM AIR FILTER

FOR KAWASAKI KLX 110 02-25

- HiFloFiltro® competition off-road air filters are manufactured using a special dual-layer foam formulated to maximize filtration with optimum airflow for improved power
- Top-quality materials and superior construction allow the filter to be used over and over again without any loss of performance
- Direct replacement of original equipment filter with no need to change carburetor jets or settings
- For the full line of foam air filters see pages 1582-1583 of the 2024 Parts Europe Offroad catalog



DESCRIPTION

Foam air filter

PART

1011-4786

DISCLAIMER: SEE PAGE 4 FOR IMPORTANT INFORMATION REGARDING CERTAIN WARRANTY AND EMISSION CONTROL REGULATION COMPLIANCE AND NOISE REGULATION INFORMATION.



1011-4883



AIR FILTERS

- DT-1's world-class foam technology delivers maximum airflow while maintaining critical engine protection
- Their Super Seal base eliminates the need for grease and creates the cleanest and best seal on the market
- All DT-1 Air Filters are handmade with the highest quality bonded dual, triple and evolution foam available
- DT-1 Air Filters come non-oiled or pre-oiled with the highest quality flame-resistant biodegradable filter oil
- See pages 1584-1589 of the 2024 Parts Europe Offroad catalog for the full line of DT-1 air filters

SUPER SEAL STANDARD DUAL LAYER FOAM AIR FILTERS

- DT-1 standard air filters are constructed with high quality 15 mm dual-stage foam
- Custom-designed for each air box and filter cage for the best fitment and performance

FITS MODELS	DUAL FOAM, NOT OILED	DUAL FOAM, PRE-OILED	AIRBOX COVER
FANTIC			
XX 125 21-22	1011-4883	1011-4884	-
XX 250 21-22	1011-4883	1011-4884	-
XE 125 21-22	1011-4883	1011-4884	-
GASGAS			
MC 50 24-25	1011-4881	-	-
MC 65 24-25	1011-4882	1011-4893	-
HUSQVARNA			
TC 50 24-25	1011-4881	-	-
TC 65 24-25	1011-4882	1011-4893	-
KAWASAKI			
KX 450/KX 450X 24-25	1011-4894	1011-4895	-
KTM			
SX 50 24-25	1011-4881	-	-
SX 65 24-25	1011-4882	1011-4893	-
SX 125 23-25	-	-	1011-4870
SX 150 23-25	-	-	1011-4870
SX 250 23-25	-	-	1011-4870
SX 300 23-25	-	-	1011-4870
SX-F 250 Factory Edition 23-25	-	-	1011-4870
SX-F 350 23-25	-	-	1011-4870
SX-F 450 Factory Edition 22-25	-	-	1011-4870

AIR BOX COVERS

- Prevent water and dirt from entering air box when cleaning your bike
- Molded to fit onto the air box, and the sealing ring creates a leak-free seal

FITS MODELS	DUAL FOAM, NOT OILED	DUAL FOAM, PRE-OILED	AIRBOX COVER
KTM (CONT)			
EXC 150 24-25	-	-	1011-4870
EXC 250 24-25	-	-	1011-4870
EXC 300 24-25	-	-	1011-4870
EXC-F 250 24-25	-	-	1011-4870
EXC-F 350 24-25	-	-	1011-4870
EXC-F 450 24-25	-	-	1011-4870
TM			
EN 125 22	1011-4892	-	-
EN 250 22	1011-4892	-	-
EN 300 22	1011-4892	-	-
EN 450 Fi 22	1011-4892	-	-
EN 530 F 22	1011-4892	-	-
EN 250 F 22	1011-4892	-	-
MX 125 22	1011-4892	-	-
MX 144 22	1011-4892	-	-
MX 250 22	1011-4892	-	-
MX 250 Fi 22	1011-4892	-	-
MX 300 22	1011-4892	-	-
MX 450 Fi 22	1011-4892	-	-
MX 530 F 22	1011-4892	-	-

CARBON FIBER AIR FILTER CAGES

- An open air filter cage built of reinforced high-temperature carbon fiber
- One piece design, no bolts or welding
- Open design is approximately 30% lighter than an aluminum air cage
- Provides improved support for the air filter and prevents vibrations at high rpms
- Flexible, can tolerate high temperatures

FITS MODEL	PART #	FITS MODEL	PART #	FITS MODEL	PART #
GASGAS		HUSQVARNA (CONT)		KTM (CONT)	
MC 125 24-25	1011-4941	TC 250 23-25	1011-4941	SX 300 TBI 23-25	1011-4941
MC 250 24-25	1011-4941	FC 250 Rockstar Edition 22-25	1011-4941	SX-F 250 Factory Edition 22-25	1011-4941
MC 250F 24-25	1011-4941	FC 250 23-25	1011-4941	SX-F 250 23-25	1011-4941
MC 350F 24-25	1011-4941	FC 350 23-25	1011-4941	SX-F 350 23-25	1011-4941
MC 450F 24-25	1011-4941	FC 450 Rockstar Edition 22-25	1011-4941	SX-F 450 Factory Edition 22-25	1011-4941
EC 250 24-25	1011-4941	FC 450 23-25	1011-4941	SX-F 450 23-25	1011-4941
EC 300 24-25	1011-4941	TE 250 24-25	1011-4941	EXC 150 TBI 24-25	1011-4941
EC 250F 24-25	1011-4941	TE 300 24-25	1011-4941	EXC 250 TBI 24-25	1011-4941
EC 300F 24-25	1011-4941	FE 350 24-25	1011-4941	EXC 300 TBI 24-25	1011-4941
EC 350F 24-25	1011-4941	FE 450 24-25	1011-4941	EXC-F 250 24-25	1011-4941
EC 450F 24-25	1011-4941	FE 501 24-25	1011-4941	EXC-F 350 24-25	1011-4941
EC 500F 24-25	1011-4941	KAWASAKI		EXC-F 450 24-25	1011-4941
HONDA		KX 250 25	1011-4943	EXC-F 450 24-25	1011-4941
CRF250R/RX 22-24	1011-4942	KX 450 24-25 (all)	1011-4943	YAMAHA	
CRF450R/RX/RWE 21-24	1011-4942	KTM		YZ 250F 24-25	1011-4947
HUSQVARNA		SX 125 TBI 23-25	1011-4941	YZ 450F 23-25	1011-4947
TC 125 23-25	1011-4941	SX 250 TBI 23-25	1011-4941		

1011-4942



DISCLAIMER: SEE PAGE 4 FOR IMPORTANT INFORMATION REGARDING CERTAIN WARRANTY AND EMISSION CONTROL REGULATION COMPLIANCE AND NOISE REGULATION INFORMATION.

- EXHAUST
- LUGGAGE
- BIKE STANDS & ACCESSORIES
- HANDLEBARS & HAND CONTROLS
- FOOTPEGS & FOOT CONTROLS
- BODY
- GRAPHICS & SEATS
- SPROCKETS
- CHAINS
- BRAKES
- WHEELS & ACCESSORIES
- SUSPENSION
- ELECTRICAL & GAUGES
- LIGHTING
- ENGINE
- FUEL/AIR SYSTEMS
- HARDWARE & MERCHANDISING

EXHAUST

LUGGAGE

BIKE STANDS & ACCESSORIES

HANDLEBARS & HAND CONTROLS

FOOTPEGS & FOOT CONTROLS

BODY

GRAPHICS & SEATS

SPROCKETS

CHAINS

BRAKES

WHEELS & ACCESSORIES

SUSPENSION

ELECTRICAL & GAUGES

LIGHTING

ENGINE

FUEL/AIR SYSTEMS

HARDWARE & MERCHANDISING



SAFETY WIRE

- Used to secure glue-on grips, lock-wire bolts and other fasteners
- Aircraft grade 0.032 in diameter stainless steel safety wire
- High-quality 304 stainless steel resists corrosion and rust
- Tested and used by top motorcycle racers and mechanics
- Convenient 50' easy access spool



DESCRIPTION

Safety wire

PART

0633-0034



PIT MAT

- Environmentally friendly pit mat
- Can absorb up to 6 L of fluid like radiator coolant, oil, and any other solvent-based products that can harm the environment, by being contained within the mat, or help absorb mud and water
- Not only are they lightweight, but can easily be washed and reused
- Measure: 78,74 cm x 76,2 cm (30" x 31")



DESCRIPTION

Moose Offroad

PART

9905-0234



COURSE ARROWS

- Ink formula resists sun fade and is less than tasty to insects and wildlife
- Heavy-duty lamination on both sides of arrow
- Made from heavy-duty card stock
- Sold in packs of 50
- See page 1611 of the 2024 Parts Europe Offroad catalog for additional Moose Racing course arrows

DESCRIPTION

Green/white

PART

9901-0323



ECE TYPE APPROVED

This logo symbolizes that the article conforms to applicable UN ECE regulations. Type approved means that a product meets a minimum set of regulatory, technical and safety requirements.



ECE R90 TYPE APPROVED

This logo symbolizes that the article conforms to applicable UN ECE R90 regulations. Type approved means that a product meets a minimum set of regulatory, technical and safety requirements.



PPE (Personal Protective Equipment)

This logo indicates the article's conformity with the Essential Health and Safety Requirements of Regulation (EU) 2016/425.



EC TYPE APPROVED

This logo symbolizes that the article conforms to applicable EU EC directives. Type approved means that a product meets a minimum set of regulatory, technical and safety requirements.



EU TYPE APPROVED

This logo symbolizes that the article conforms to applicable EU Regulation (generally for newer products). Type approved means that a product meets a minimum set of regulatory, technical and safety requirements.



PPE

This logo indicates the article's conformity with the Essential Health and Safety Requirements of Regulation (EU) 2016/425. (non-motorcycle articles, e.g. Watercraft articles).



ECE R22.06

This logo symbolizes that a helmet, helmet visor/shield or other helmet accessory has been tested and certified to ECE 22.06 regulation.



ART

The ART quality mark symbolizes that the lock is independently tested according to the standard for two-wheeler theft prevention. (MBT-04) and certified by the ART Foundation. The locks are rated according to a 5 stars category designation system based on the use of a lock (bicycle, E-bike, scooter, motorcycle, other). The more stars a lock has, the higher its preventative value and the better it protects against theft.



ABE

This logo symbolizes the article has been approved by KBA (German Federal Motor Transport Authority) for specific vehicle application.



TEILEGUTACHTEN (German Parts Certificate)

This logo symbolizes that the article contains a TEILEGUTACHTEN (German Parts Certificate) to ensure the legal part installation. Issued by a German inspection body.



CLASSE S.R.A.

The logo symbolizes that the anti-theft device is tested and approved according to the SRA (SÉCURITÉ et RÉPARATION AUTOMOBILES France) rules for theft prevention. The classification in the "SRA classes" includes electronic protection systems (engine cut-off, alarm, etc.) and mechanical protection systems (U-locks, chains and disc locks).



SOLD SECURE

The logo symbolizes that the lock is tested and approved according to Sold Secure (UK's testing and certification house for security products) standards for theft prevention.



ELECTRICAL WIRING

WIRE GAUGE CONVERTER

GAUGE	MM ²	MM Ø	GAUGE	MM ²	MM Ø
22	0,33	0,65	10	5,0	2,6
20	0,5	0,8	8	8,0	3,3
18	0,8	1,0	6	13,0	4,1
16	1,0	1,3	4	19,0	5,2
14	2,0	1,7	2	32,0	6,5
12	3,0	2,1	0	52,0	8,3



WIRE GAUGE SELECTOR

It's important to match up wire diameter and current properly. To choose the right gauge wire, you will need to know how much Wattage (or Amperage) you will draw and what the length of the cable will be.

NOTE: The chart below is based on a 12V system. To find the appropriate wire for 6V systems, the Amp and Watt numbers should be divided in half.

AMP	WATT	91 CM (3 FT)	152 CM (5 FT)	213 CM (7 FT)	305 CM (10 FT)	457 CM (15 FT)	AMP	WATT	91 CM (3 FT)	152 CM (5 FT)	213 CM (7 FT)	305 CM (10 FT)	457 CM (15 FT)
5A	30W	18 AWG	18 AWG	18 AWG	18 AWG	18 AWG	20A	120W	18 AWG	18 AWG	16 AWG	16 AWG	12 AWG
6A	36W	18 AWG	18 AWG	18 AWG	18 AWG	18 AWG	22A	132W	18 AWG	18 AWG	16 AWG	16 AWG	12 AWG
7A	42W	18 AWG	18 AWG	18 AWG	18 AWG	18 AWG	24A	144W	18 AWG	18 AWG	16 AWG	16 AWG	12 AWG
8A	48W	18 AWG	18 AWG	18 AWG	18 AWG	18 AWG	30A	180W	18 AWG	16 AWG	16 AWG	14 AWG	10 AWG
10A	60W	18 AWG	18 AWG	18 AWG	18 AWG	16 AWG	40A	240W	18 AWG	16 AWG	14 AWG	12 AWG	10 AWG
11A	66W	18 AWG	18 AWG	18 AWG	18 AWG	16 AWG	50A	300W	16 AWG	14 AWG	12 AWG	12 AWG	10 AWG
12A	72W	18 AWG	18 AWG	18 AWG	18 AWG	16 AWG	100A	600W	12 AWG	12 AWG	10 AWG	10 AWG	6 AWG
15A	90W	18 AWG	18 AWG	18 AWG	18 AWG	14 AWG	150A	900W	10 AWG	10 AWG	8 AWG	8 AWG	4 AWG
18A	108W	18 AWG	18 AWG	16 AWG	16 AWG	12 AWG	200A	1200W	10 AWG	8 AWG	8 AWG	6 AWG	4 AWG

METRIC AND U.S.A STANDARD CONVERSIONS

METRIC TO U.S.A.	
METRIC	U.S.A.
VOLUME	
Milliliter (ml)	0.0338 fluid ounce (fl oz)
Milliliter (ml)	0.001057 quart
Milliliter (ml)	0.06102 cubic inch
Liter (L)	0.264 gallon (gal)
Liter (L)	61.02 cubic inch
Liter (L)	0.0353 cubic feet
LENGTH	
Millimeter (mm)	0.039 inch (in)
Centimeter (cm)	0.393 inch (in)
Centimeter (cm)	0.0328 feet (ft)
Meter (m)	3.28 feet (ft)
Kilometer (km)	0.62 mile (mi)
WEIGHTS	
Gram (g)	0.035 ounce net weight (oz net wt)
Kilogram (kg)	2.2 pounds (lbs)
PRESSURE	
Bar	14.5 psi
TEMPERATURE	
Degrees Celsius (°C)	Degrees Fahrenheit (°F -32) x 5/9
POWER	
Kilowatt (kw)	1.34 horsepower (hp)
SPEED	
Kilometers per hour (km/h)	0.62 miles per hour (mph)
TORQUE	
Newton meters	8.85 inch force-pounds (in lbs)
Newton meters	0.738 foot force-pounds (ft lbs)
ENGINE CAPACITY	
Cubic centimeters (cc) (cm ³)	0.06102 (ci)
FUEL CONSUMPTION	
Kilometers per liter (km/l)	2.35 miles per gallon (mpg)
Liters per kilometer (l/km)	0.425 gallons per mile (gpm)

U.S.A. TO METRIC	
U.S.A.	METRIC
VOLUME	
Fluid ounce (fl oz)	29.57 milliliter (ml)
Quart	946.4 milliliter (ml)
Cubic inch	16.39 milliliter (ml)
Gallon (gal)	3.785 liter
Cubic inch	0.01639 liter
Cubic feet	28.3169 liter
LENGTH	
Inch (in)	25.4 millimeters (mm)
Inch (in)	2.54 centimeters (cm)
Foot (ft)	30.5 centimeters (cm)
Foot (ft)	0.305 meter (m)
Mile (mi)	1.609 kilometer
WEIGHTS	
Ounce net weight (oz net wt)	28.35 grams (g)
Pound (lb)	0.45 kilograms (kg)
PRESSURE	
PSI	0.0689 Bar
TEMPERATURE	
Degrees Fahrenheit (°F)	Degrees Celsius (°C x 1.8) + 32
POWER	
Horsepower (hp)	0.7457 kilowatt (kw)
SPEED	
Miles per hour (mph)	1,6093 kilometers per hour (km/h)
TORQUE	
Inch force-pounds (in lbs)	0.113 newton meters (nm)
Foot force-pounds (ft lbs)	1.356 newton meters (nm)
ENGINE CAPACITY	
Cubic Inch Displacements (CID)	16.39 cubic centimeters (cc) (cm ³)
FUEL CONSUMPTION	
Miles per gallon (mpg)	0.425 kilometers per liter (km/l)
Gallons per mile (gpm)	2.35 liters per kilometer (l/km)



We Support The Sport®!

We are the #1 resource for powersports products. We support our dealers, vendors and fans at races, rallies, special events and showcases.

DEALER POLICIES

Please visit: www.partseurope.eu

CATALOG CONTENTS

We believe the contents and specifications of this catalog are correct. We assume no liability for errors in listings, specifications, part numbers, prices or model applications. We reserve the right to change specifications, product descriptions, product quality, pricing and application at any time without further notice and without further obligation. The reproduction of any material from this catalog is forbidden without our written approval.

iPad®, iPhone®, iPhoto®, iPod®, iPod classic®, iPod nano®, iPod shuffle®, iPod touch®, MacBook®, MacBook Air® and PowerBook® are registered trademarks of Apple Inc.

DuPont™ and Kevlar® are trademarks or registered trademarks of E.I. du Pont de Nemours and Company. Supplex® and Cordura® are registered trademarks

of Invista North America S.A.R.L. D30® is a registered trademark of Design Blue Limited. YKK® Vislon® and AquaGuard® are registered trademarks of YKK Corporation.

All model designations and applications used herein are determined by the manufacturer as USA and/or European specific. Contact the individual manufacturer for additional international model information.

WARRANTIES AND GUARANTEES

We do not guarantee the items sold by us or warrant the merchantability or fitness of purpose. Manufacturers supply their own warranties and guarantees and most of them do not permit a wholesaler or distributor to make any adjustment, replace any part or accept for return or exchange any defective or unsatisfactory item. Please follow the guarantee instructions when provided by the manufacturer. Any damages arising from the design or manufacturing of any item are the sole responsibility of the manufacturer.



dragspecialties.eu

**PARTS
EUROPE**

partseurope.eu

Parts Europe GmbH

Conrad-Röntgen-Strasse 2

54332 Wasserliesch/Trier, Germany

Sales: +49 6501 9695-2000

Fax: +49 6501 9695-2650

Reception: +49 6501 9695-0

info@partseurope.eu

A DIVISION OF LEMANS CORPORATION

PO Box 5222, Janesville, WI 53547-5222 • 608-758-1111

COPYRIGHT 2025 • LeMans Corporation • ALL RIGHTS RESERVED

These materials may not be copied or reproduced in any manner without written permission of LeMans Corporation.

OFFROAD 2025 UPDATE

OUR CATALOGUES
COVER HARLEY, INDIAN,
SCOOTER, ATV, WATERCRAFT,
AND MUCH MORE!
BROWSE THEM ALL HERE



TIRES, OILS, TOOLS
& CHEMICALS.
EVERYTHING AVAILABLE IN
ONE CATALOGUE!
DISCOVER THE LATEST
TIRES & TOOLS CATALOGUE



PARTS EUROPE®

9901-3526
PRINTED IN GERMANY



ONLINE AVAILABLE AS PAGE FLIPPER IN
    
PRINTED IN 5 LANGUAGES

